



US00D511256S

(12) **United States Design Patent**
Searl

(10) **Patent No.:** **US D511,256 S**

(45) **Date of Patent:** **** Nov. 8, 2005**

(54) **SEVEN SIDED TABLE**

D349,824 S * 8/1994 Ball D6/482
D456,644 S * 5/2002 Weaver D6/484

(76) **Inventor:** **David R. Searl**, 2001 Old Airport Rd.,
Weatherford, TX (US) 76087

* cited by examiner

(**) **Term:** **14 Years**

Primary Examiner—Janice E. Seeger

(74) *Attorney, Agent, or Firm*—Robert E. Nail

(21) **Appl. No.:** **29/205,924**

(57) **CLAIM**

(22) **Filed:** **May 24, 2004**

The ornamental design for an seven sided table, as shown
and described.

(51) **LOC (8) Cl.** **06-03**

(52) **U.S. Cl.** **D6/484; D6/489**

(58) **Field of Search** D6/480–489, 495,
D6/497–499, 511; 108/151, 153.1, 155,
156, 157.1, 161; 248/188, 188.1, 188.7,
188.8

DESCRIPTION

Article is to be used as ornamental furniture.
FIG. 1 is a top view of the article.
FIG. 2 is a front view of the article.
FIG. 3 is a view of the right side of the article.
FIG. 4 is a bottom view of the article.
FIG. 5 is a partial perspective view of an alternate leg shape
for legs of the article; and,
FIG. 6 is a perspective view of the article.

(56) **References Cited**

U.S. PATENT DOCUMENTS

D171,475 S * 2/1954 Yarger D6/485
D249,107 S * 8/1978 Rodriguez D6/430
D260,712 S * 9/1981 Potucek D6/483

1 Claim, 1 Drawing Sheet

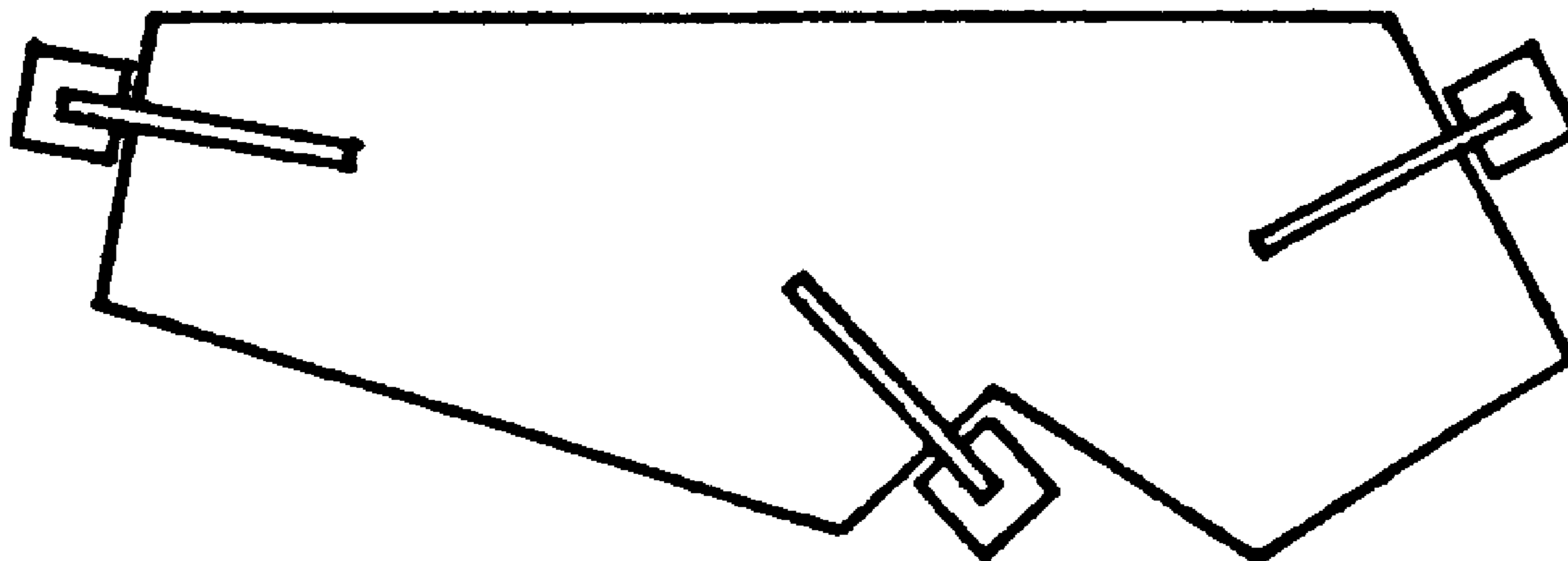

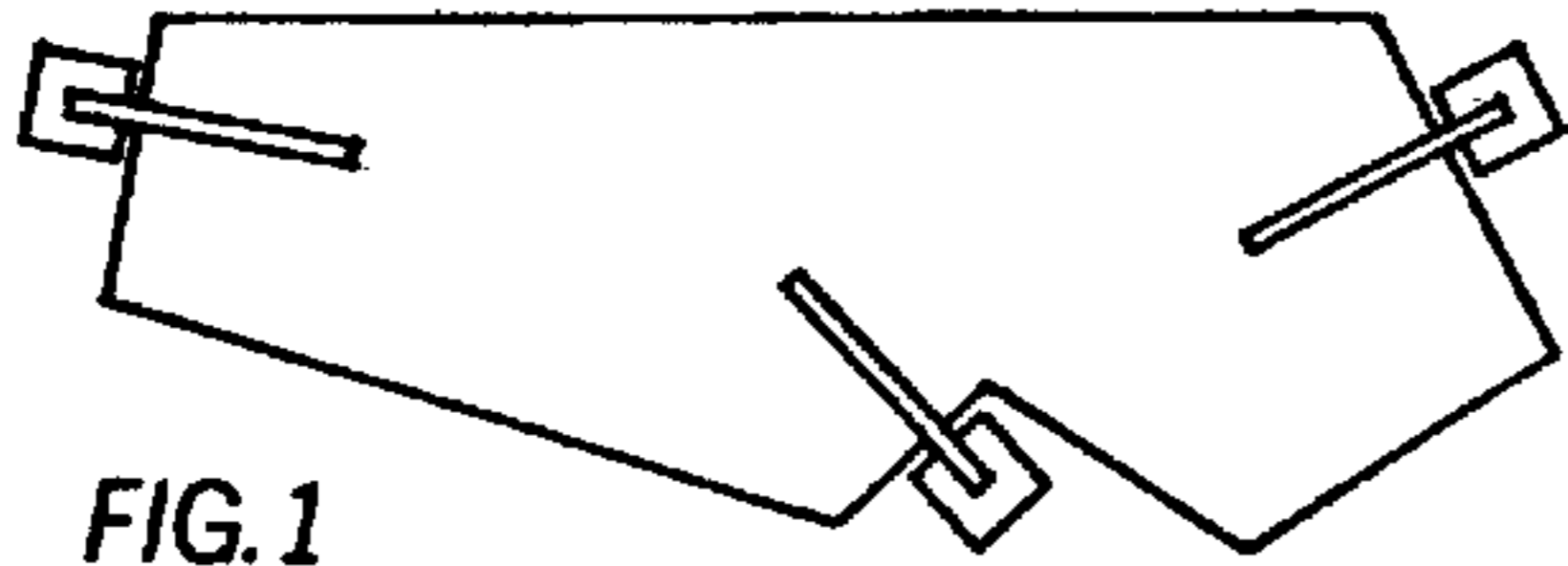

FIG. 1

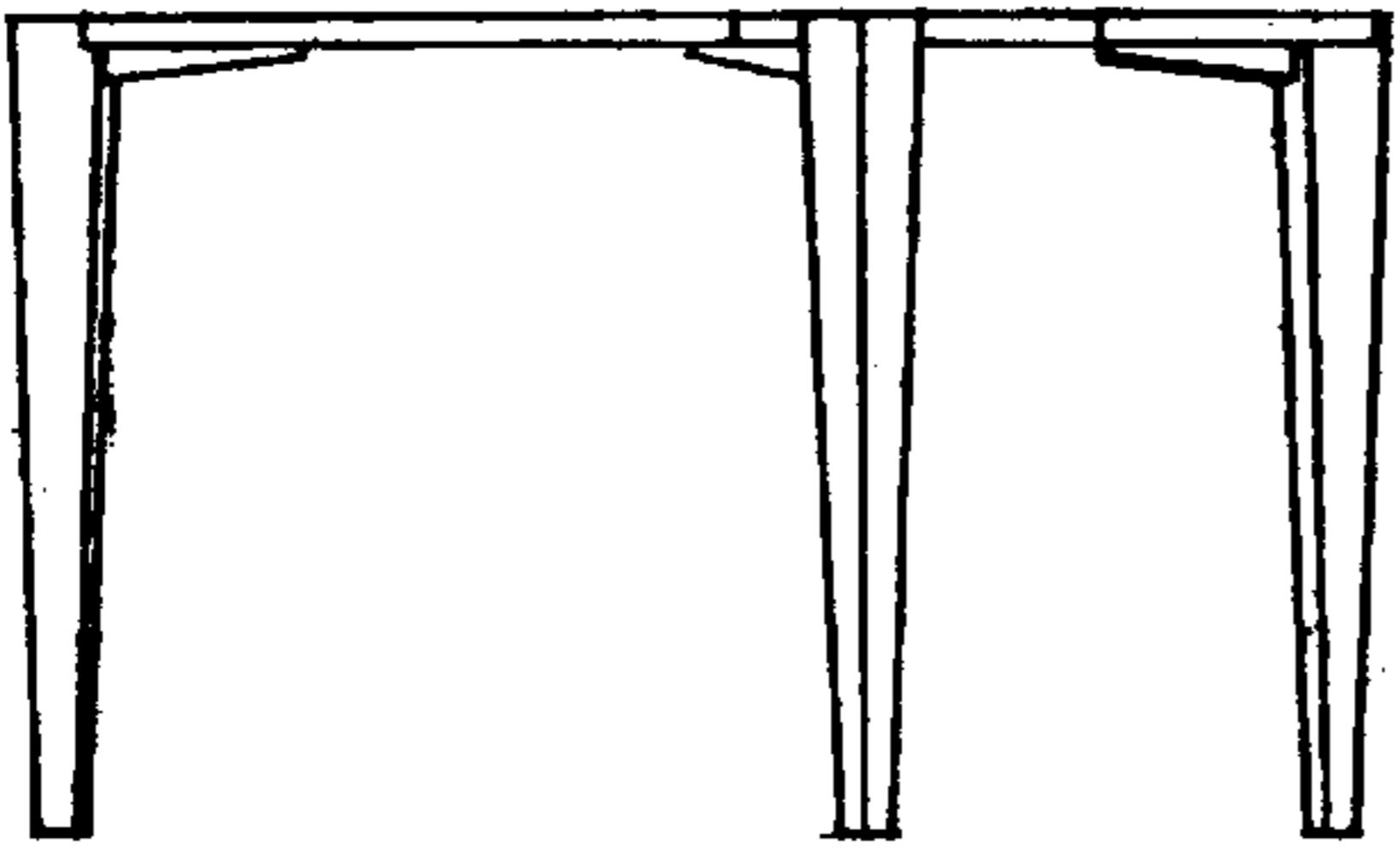

FIG. 2

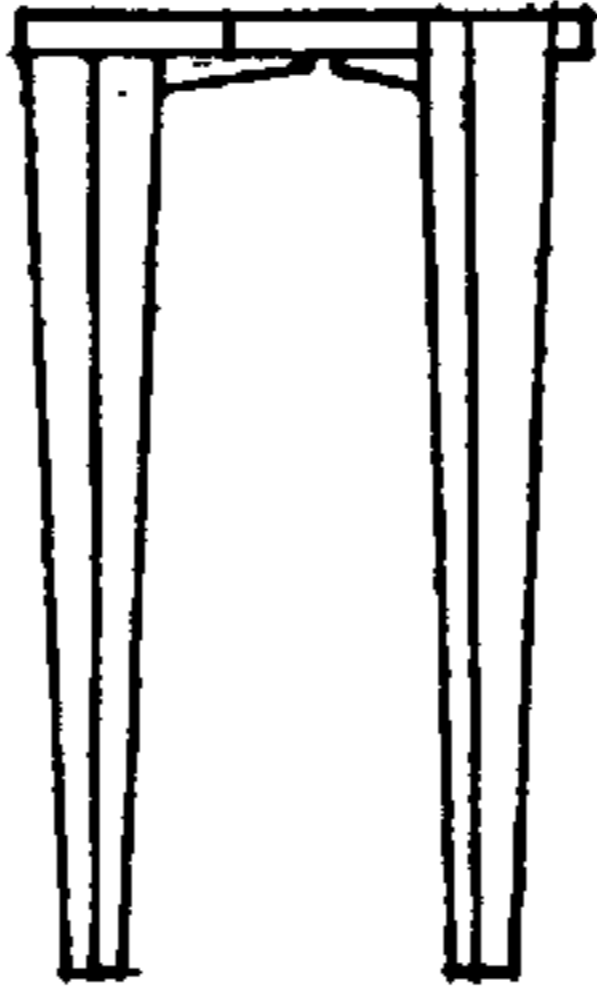

FIG. 3

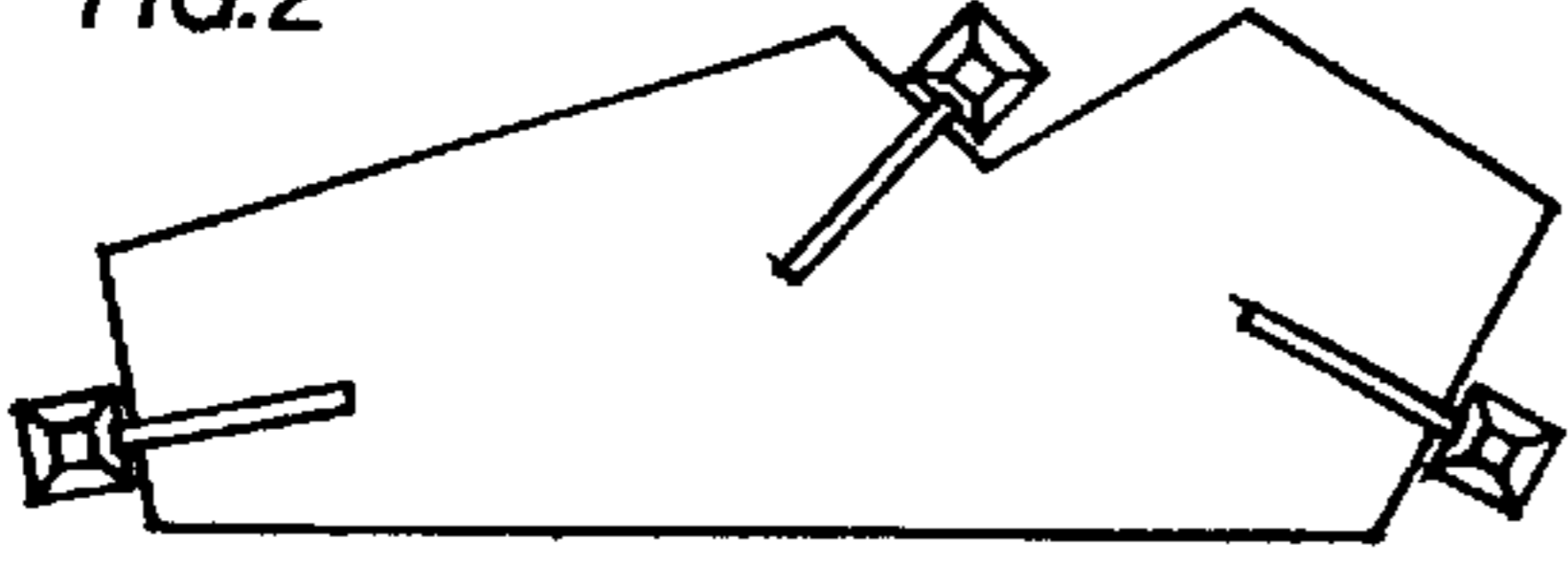

FIG. 4

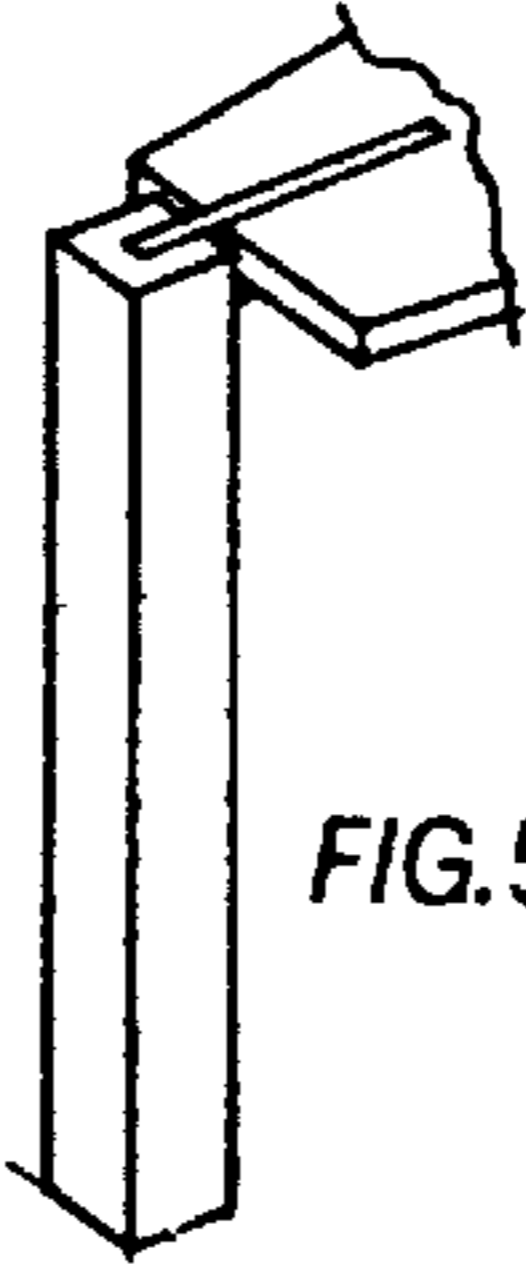

FIG. 5

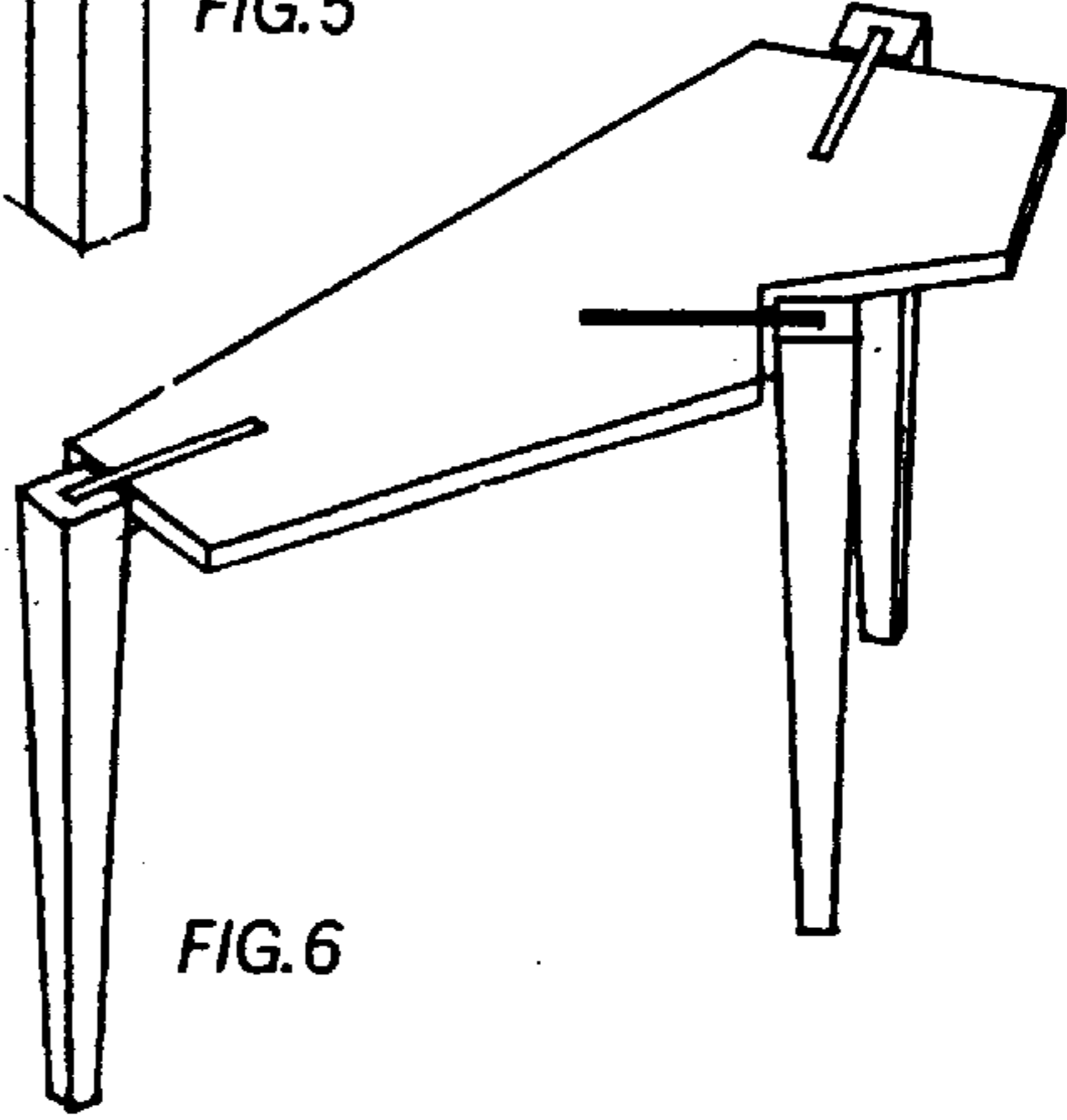

FIG. 6