



US00D511135S

(12) **United States Design Patent** (10) **Patent No.:** **US D511,135 S**
Krieger et al. (45) **Date of Patent:** **** Nov. 1, 2005**

(54) **JUMP STARTER**

(75) Inventors: **Michael Krieger**, Miami Beach, FL (US); **Kevin Ellsworth**, Hollywood, FL (US)

(73) Assignee: **Vector Products, Inc.**, Ft. Lauderdale, FL (US)

(**) Term: **14 Years**

(21) Appl. No.: **29/196,793**

(22) Filed: **Jan. 6, 2004**

(51) **LOC (8) Cl.** **13-02**

(52) **U.S. Cl.** **D13/107**

(58) **Field of Search** D13/106-108, D13/110; D14/251, 253; 320/105, 107-116

(56) **References Cited**

U.S. PATENT DOCUMENTS

D334,560 S	*	4/1993	Wilson	D13/106
D374,859 S	*	10/1996	Guay et al.	D13/110
D403,661 S	*	1/1999	Mariani	D13/106
5,982,138 A	*	11/1999	Krieger	320/105
D423,451 S	*	4/2000	Heckenast et al.	D13/110
D432,985 S	*	10/2000	Wan	D13/107
D444,125 S	*	6/2001	Shy	D13/110
RE37,482 E	*	12/2001	Guay et al.	D13/110
D452,474 S	*	12/2001	Casarella	D13/107
D464,619 S	*	10/2002	Krieger et al.	D13/110
D466,862 S	*	12/2002	Casarella	D13/107
D482,324 S	*	11/2003	James et al.	D13/107
D483,326 S	*	12/2003	Krieger et al.	D13/107

OTHER PUBLICATIONS

- U.S. Appl. No. 29/186,129, filed date Jul. 10, 2003.
- U.S. Appl. No. 29/186,102, filed date Jul. 10, 2003.
- U.S. Appl. No. 29/186,131, filed date Jul. 10, 2003.
- U.S. Appl. No. 29/196,695, filed date Jan. 5, 2004.
- U.S. Appl. No. 29/196,744, filed date Jan. 6, 2004.
- U.S. Appl. No. 29/196,698, filed date Jan. 5, 2004.
- U.S. Appl. No. 29/196,694, filed date Jan. 5, 2004.

* cited by examiner

Primary Examiner—Alan P. Douglas

Assistant Examiner—Rosemary Tarcza

(74) *Attorney, Agent, or Firm*—Venable LLP; Robert Kinberg

(57) **CLAIM**

The ornamental design for a jump starter, as shown and described.

DESCRIPTION

FIG. 1 is a perspective view from the front-top-right side of the jump starter showing our new design; FIG. 2 is a front view of the design shown in FIG. 1; FIG. 3 is a rear view of the design shown in FIG. 1; FIG. 4 is a left side view of the design shown in FIG. 1; FIG. 5 is a right side view of the design shown in FIG. 1; FIG. 6 is a top view of the design shown in FIG. 1; and, FIG. 7 is a bottom view of the design shown in FIG. 1.

The broken lines immediately adjacent the shaded areas represent the bounds of the claimed design while all other broken lines are for illustrative purposes only; the broken lines form no part of the claimed design.

1 Claim, 7 Drawing Sheets

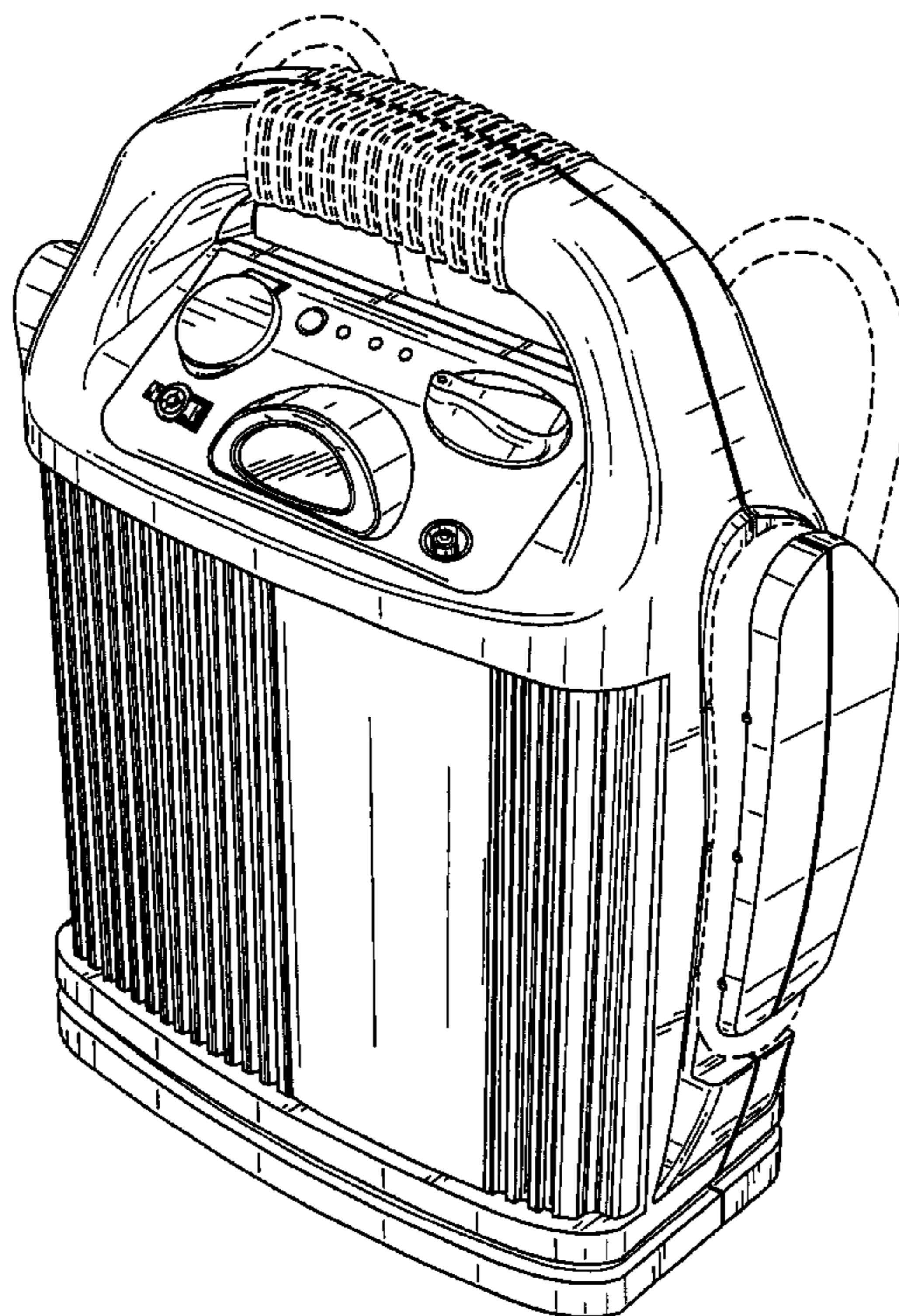

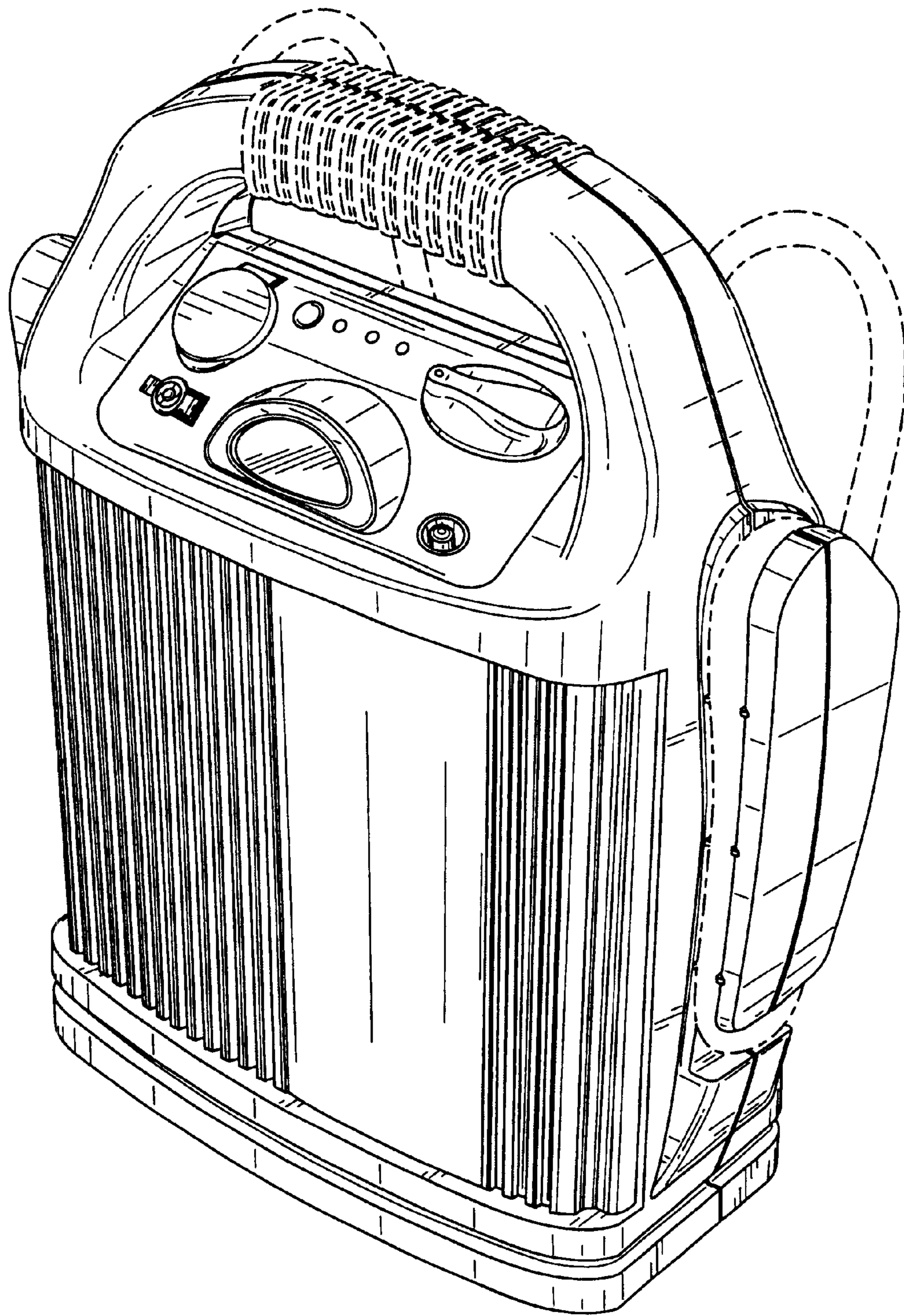

FIG. 1

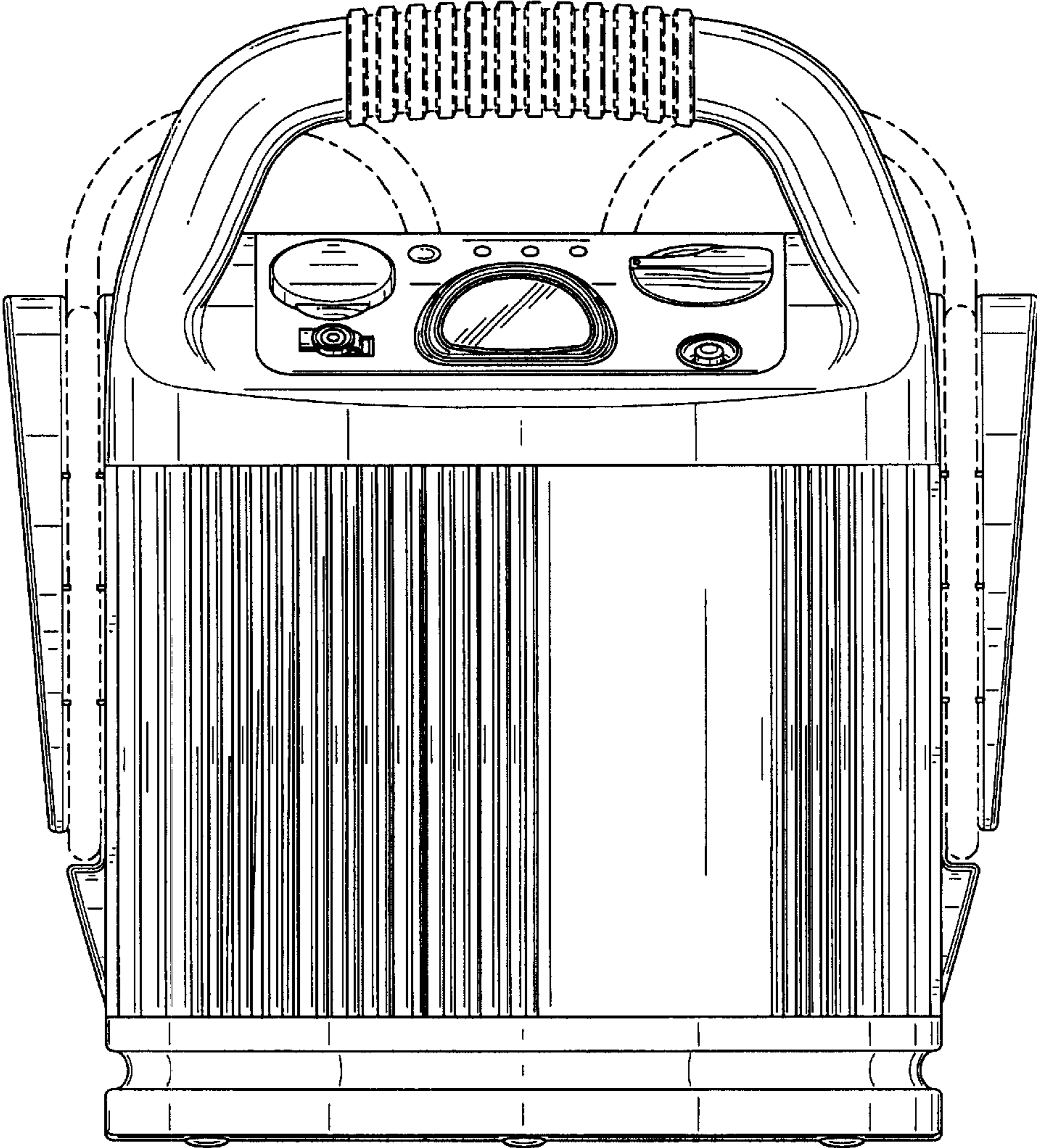

FIG. 2

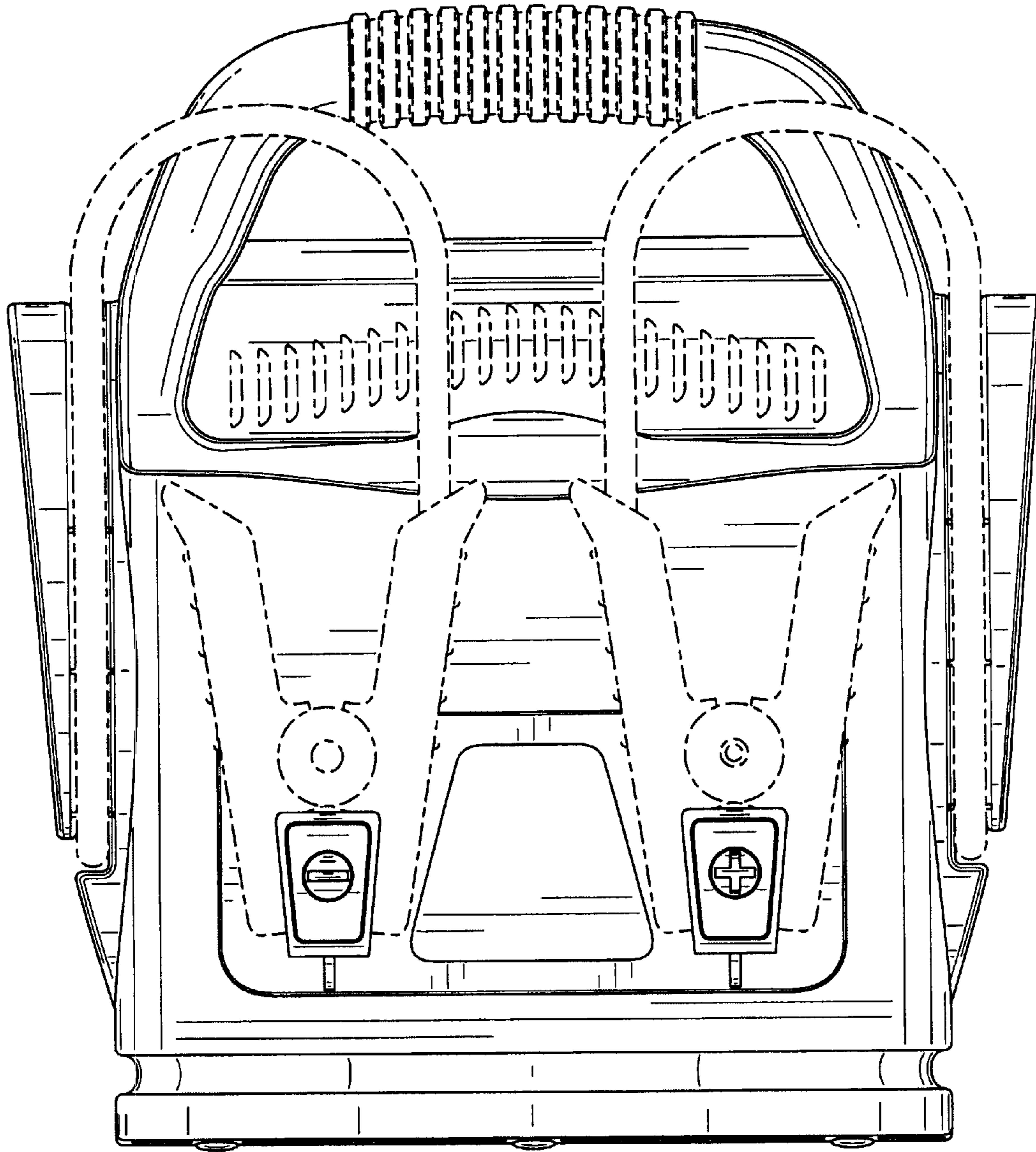

FIG. 3

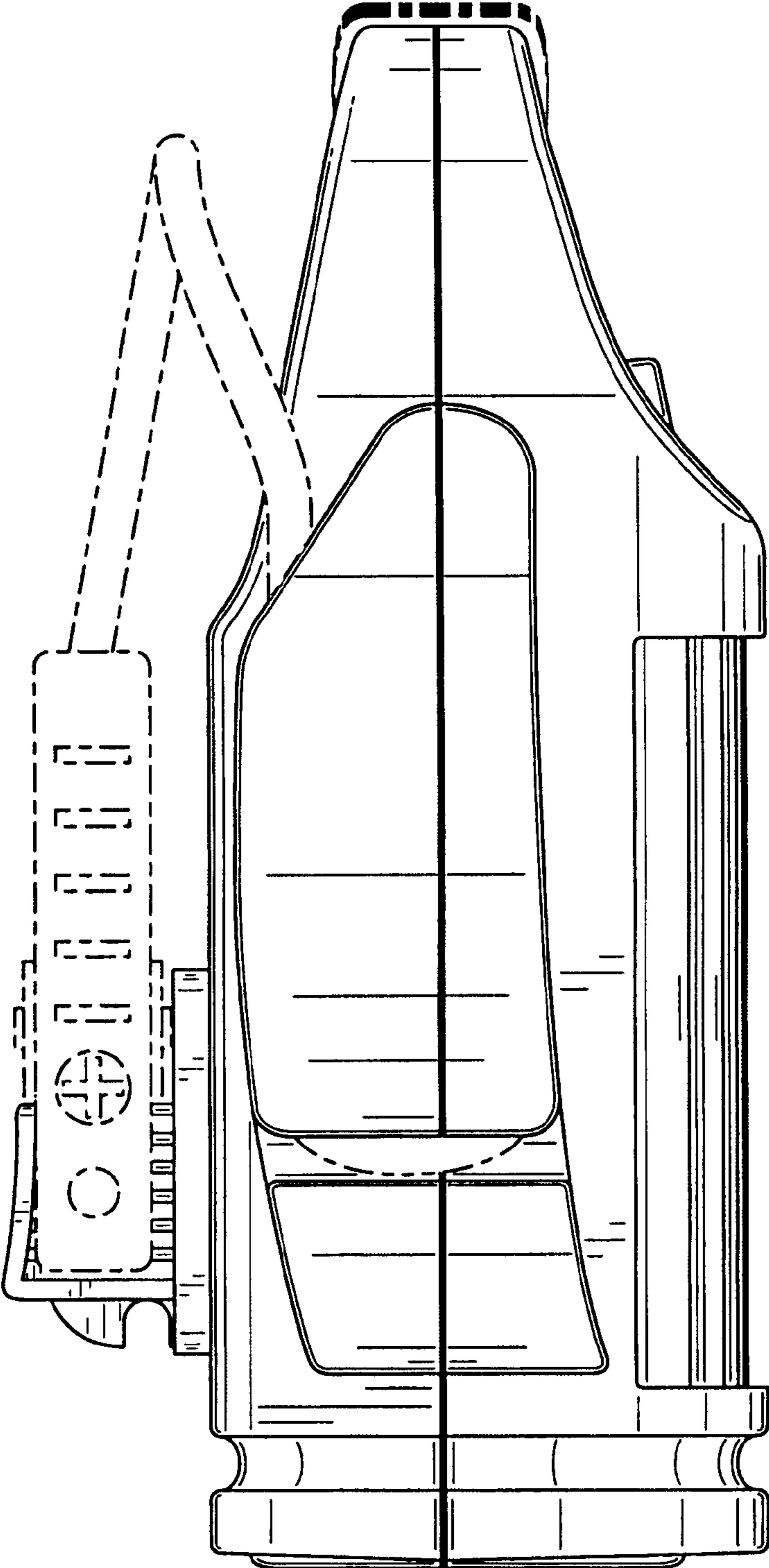

FIG. 4

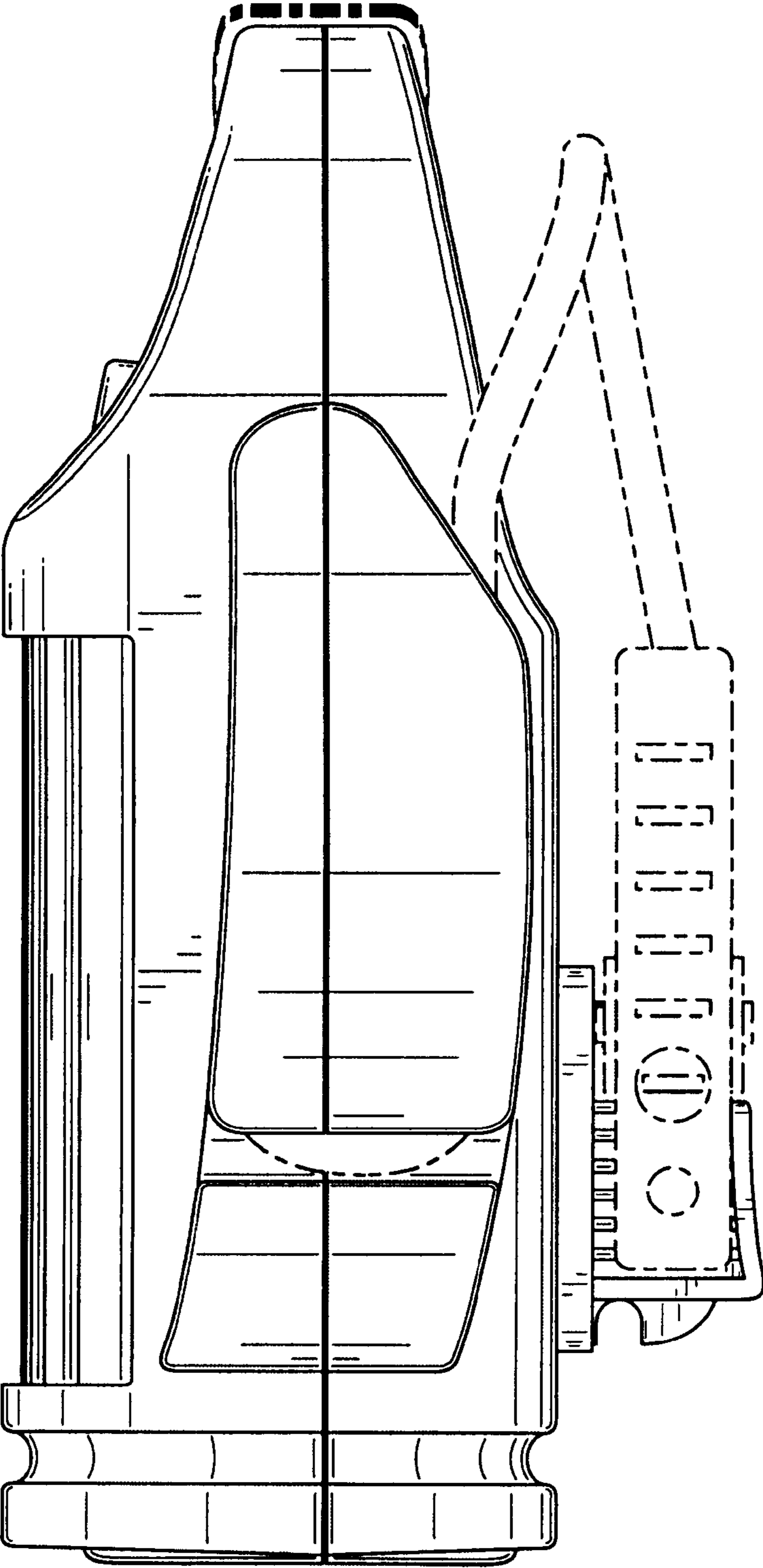

FIG. 5

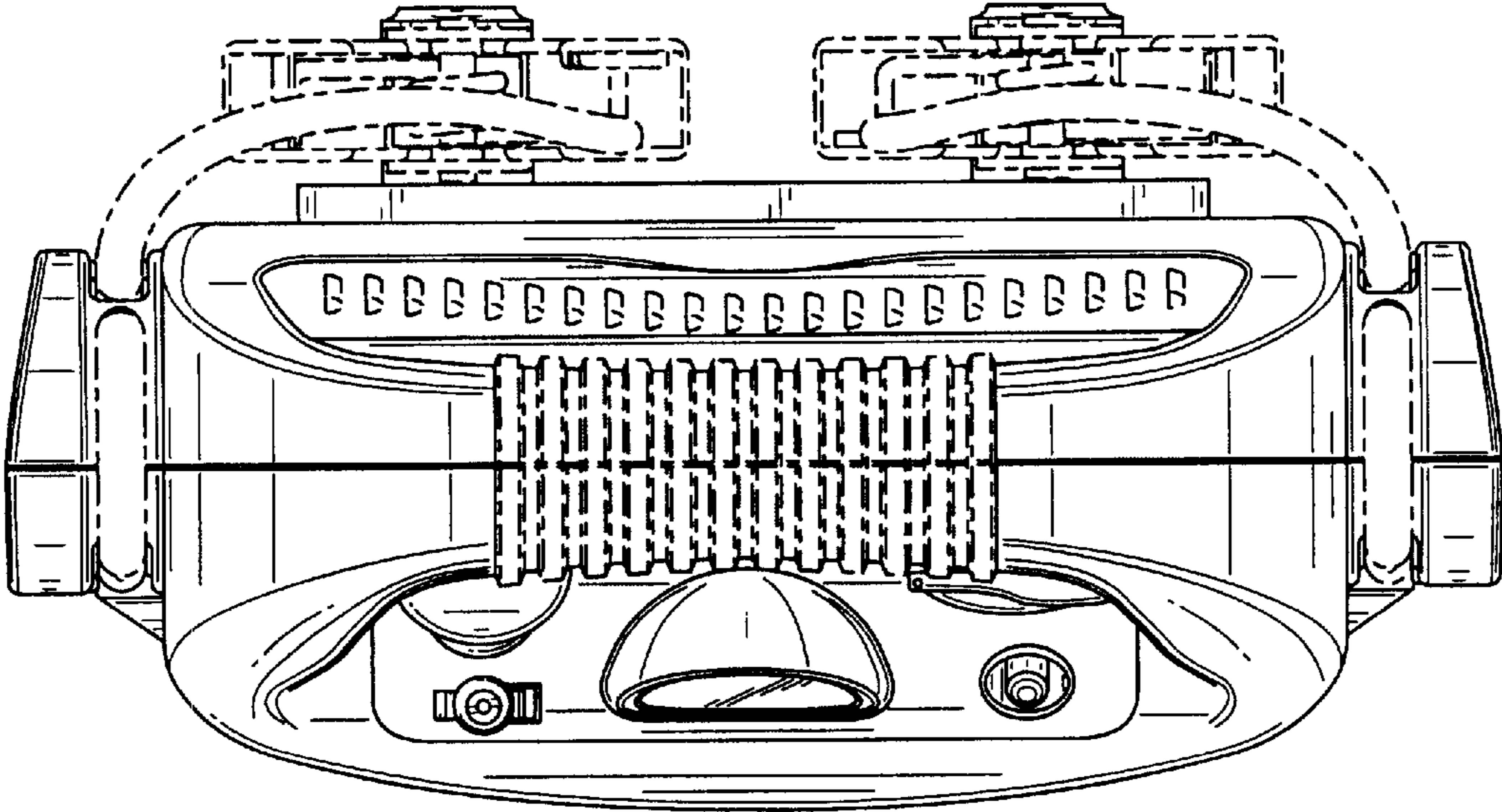

FIG. 6

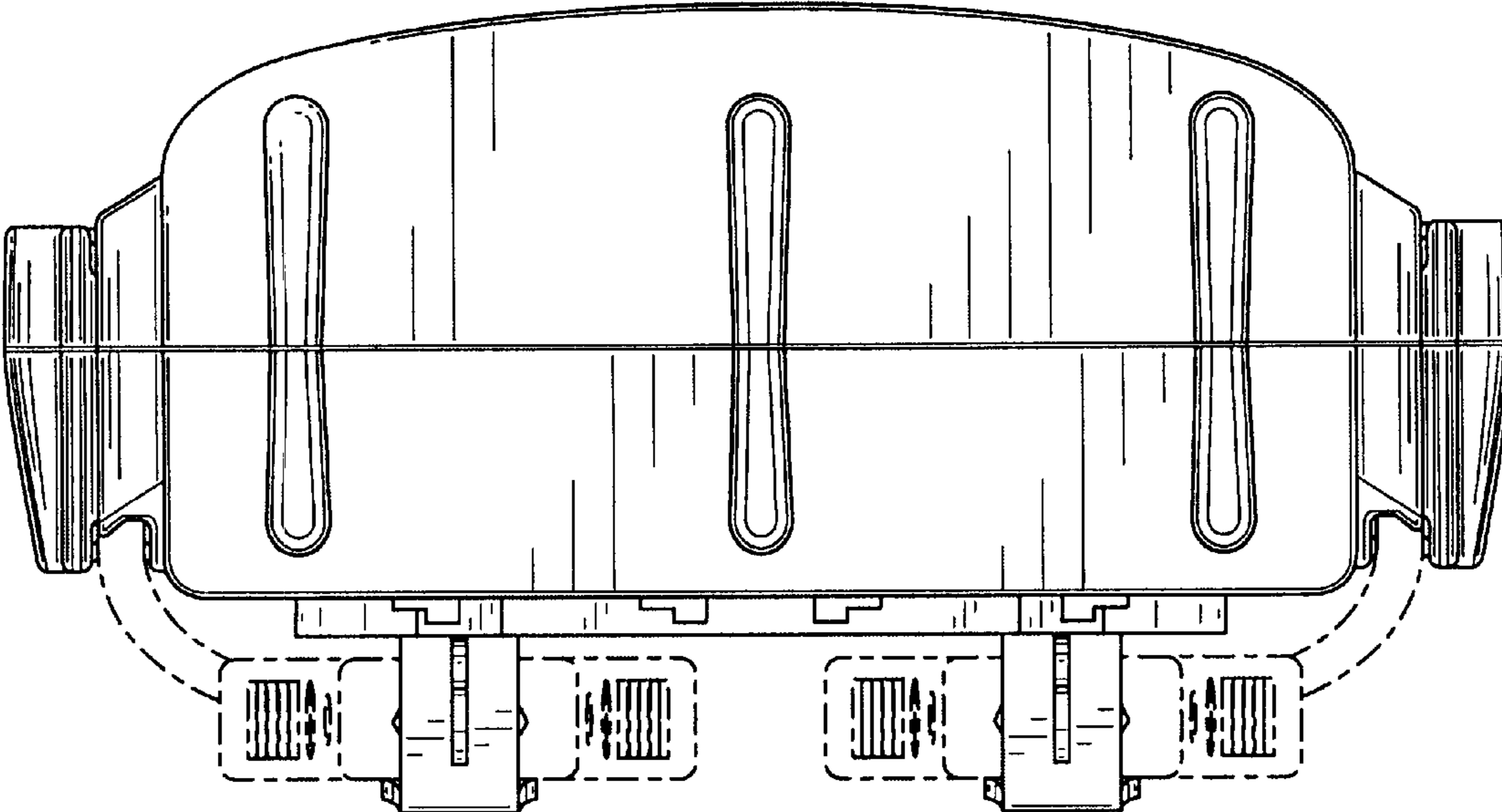

FIG. 7