



US00D510953S

(12) **United States Design Patent**  
**Chen et al.**

(10) **Patent No.: US D510,953 S**  
(45) **Date of Patent: \*\* Oct. 25, 2005**

(54) **SUPPLY ORGANIZER**

(75) Inventors: **Peter Chen**, West Windsor, NJ (US);  
**Jungkun Lee**, Edison, NJ (US)

(73) Assignee: **Officemate International Corp.**,  
Edison, NJ (US)

(\*\*) Term: **14 Years**

(21) Appl. No.: **29/221,973**

(22) Filed: **Jan. 24, 2005**

(51) **LOC (8) Cl. .... 19-06**

(52) **U.S. Cl. .... D19/77; D19/85**

(58) **Field of Search .... D19/35, 36, 65,**  
D19/75, 77, 78, 81-85, 86, 95, 99, 100;  
D7/640, 641; D3/284, 903; 206/214, 224,  
371; 211/10, 11, 13.1, 69.9, 69.1-69.8,  
70, 126.1

(56) **References Cited**

**U.S. PATENT DOCUMENTS**

D199,820 S	*	12/1964	Meeker	.....	D3/296
3,327,688 A	*	6/1967	Smith	.....	206/214
D250,653 S	*	12/1978	Tiedemann	.....	D19/85
D267,153 S	*	12/1982	Lebowitz	.....	D19/77
D280,739 S	*	9/1985	Wang	.....	D19/77

D311,213 S	*	10/1990	Ancona et al.	.....	D19/77
D358,030 S	*	5/1995	Ying	.....	D3/284
D381,686 S	*	7/1997	Chiu	.....	D19/77
D477,848 S	*	7/2003	Chen	.....	D19/78
D486,184 S	*	2/2004	Leithaeuser	.....	D19/77

\* cited by examiner

*Primary Examiner*—Martie K. Holtje

(74) *Attorney, Agent, or Firm*—Daniel Kirshner

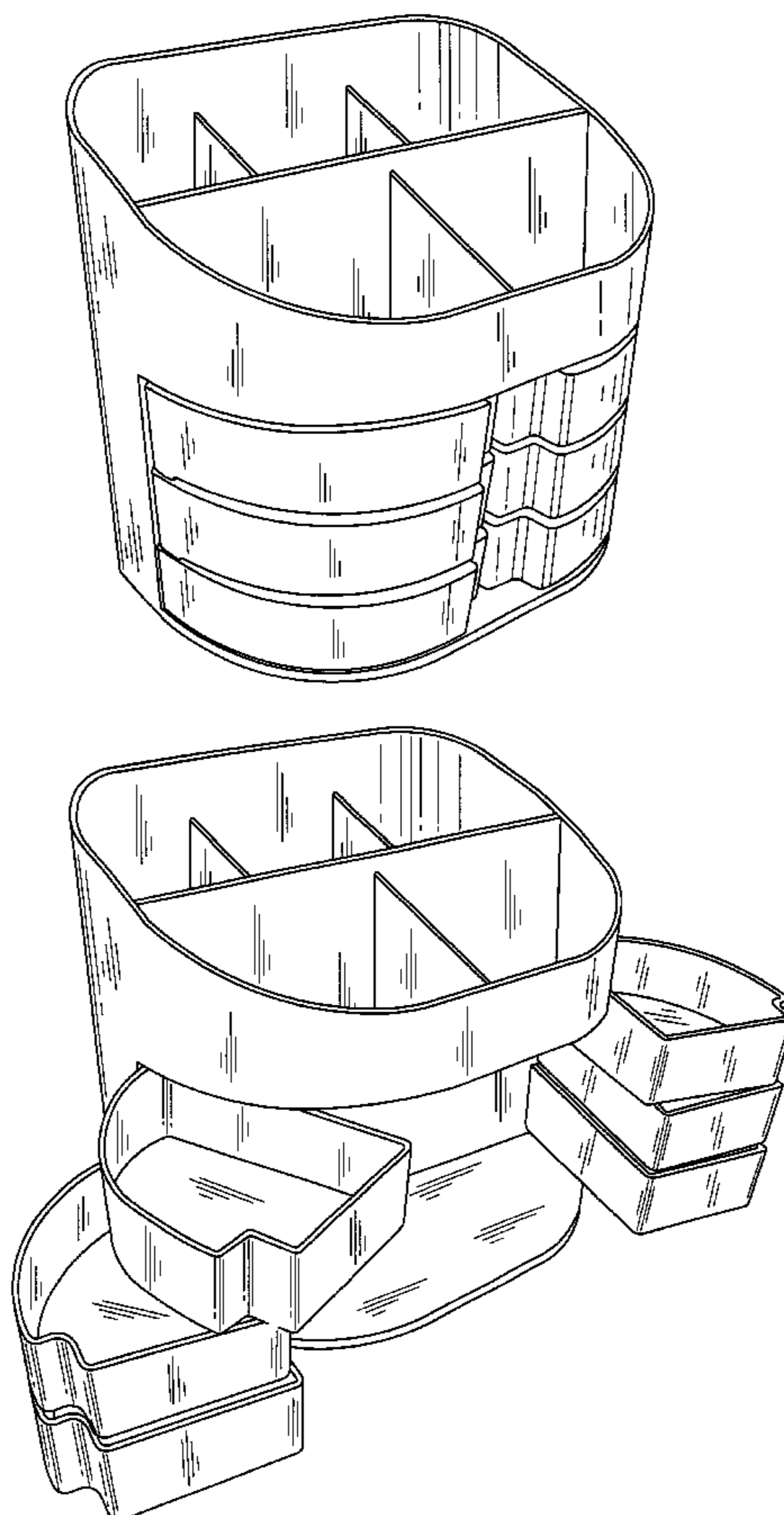
(57) **CLAIM**

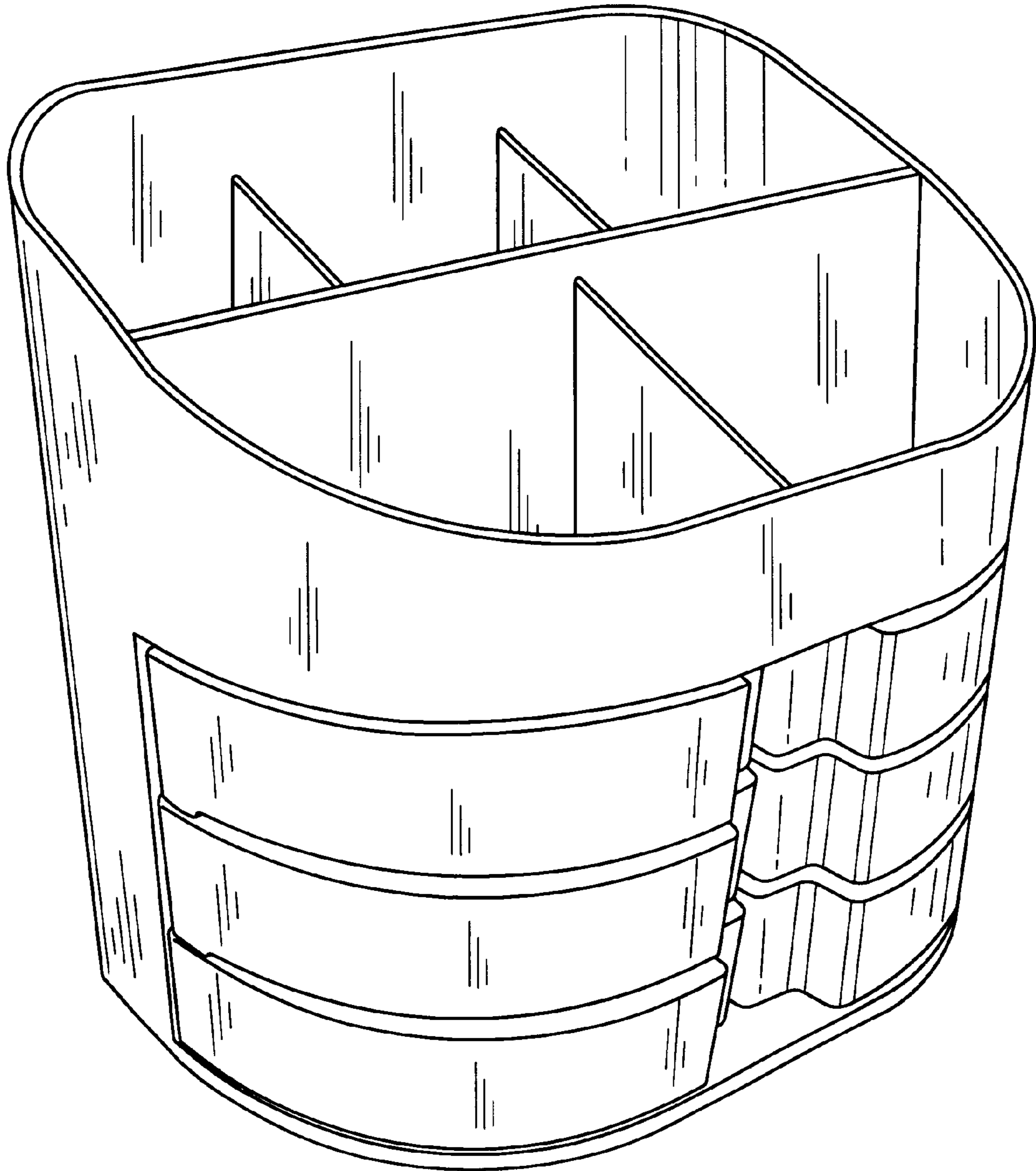
The ornamental design for a supply organizer, as shown and described.

**DESCRIPTION**

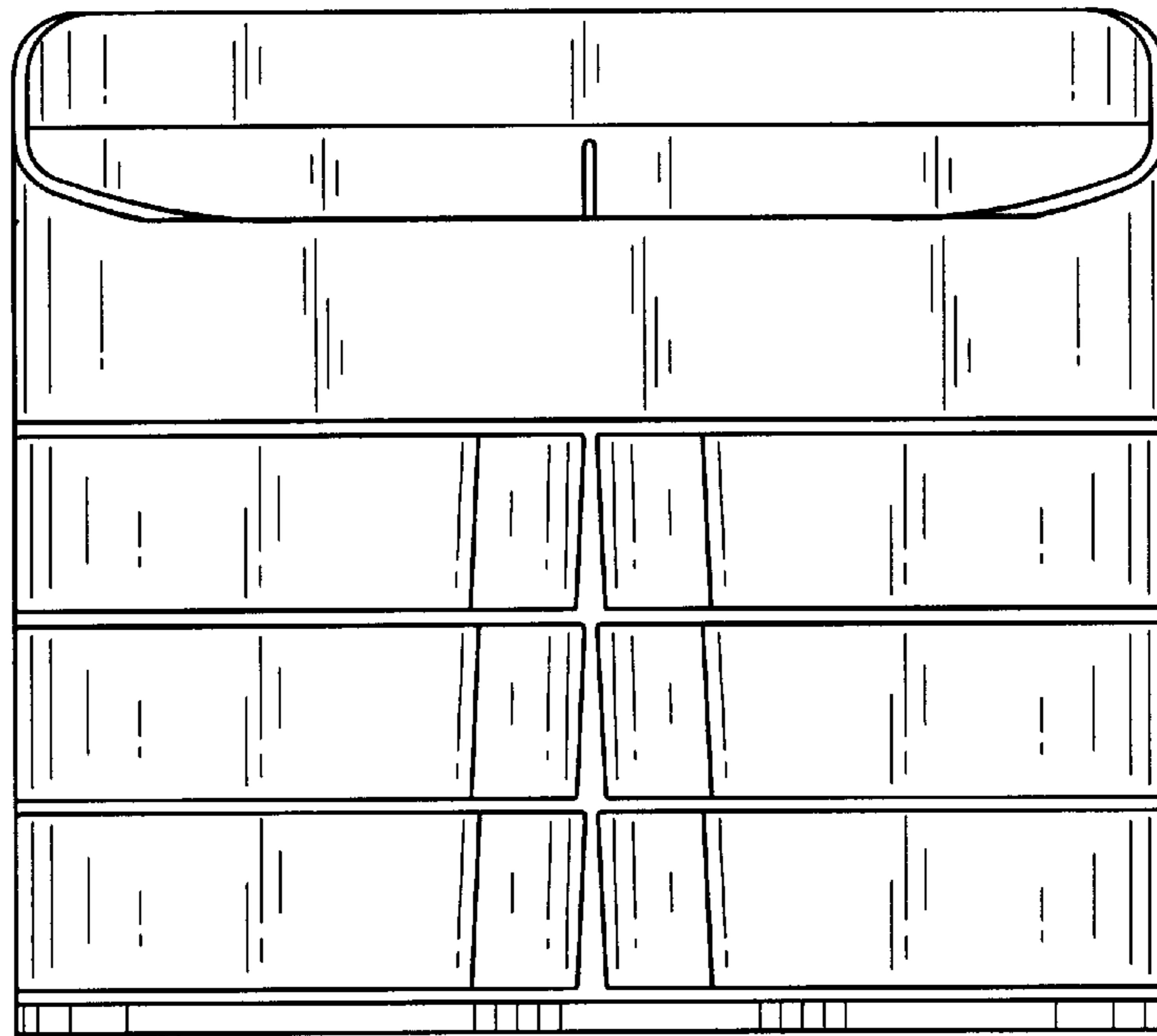
FIG. 1 is a front perspective view of a supply organizer showing our new design;  
 FIG. 2 is a front view thereof;  
 FIG. 3 is a rear view thereof;  
 FIG. 4 is right side view thereof;  
 FIG. 5 is a left side view thereof;  
 FIG. 6 is a top view thereof;  
 FIG. 7 is a bottom view thereof;  
 FIG. 8 is a front perspective view thereof showing the right side compartments opened; and,  
 FIG. 9 is a front perspective view thereof showing the right and left side compartments opened.

**1 Claim, 6 Drawing Sheets**

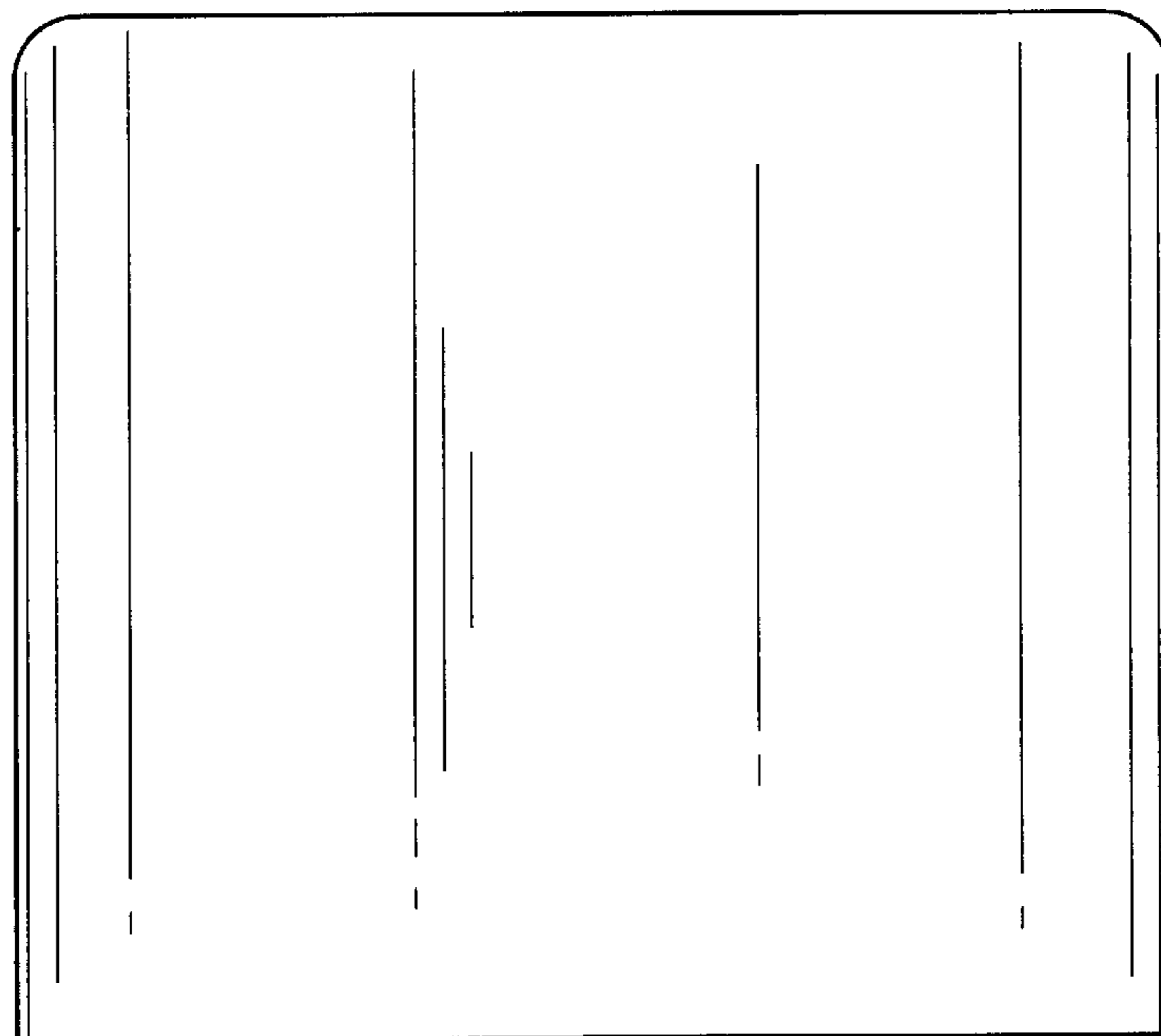




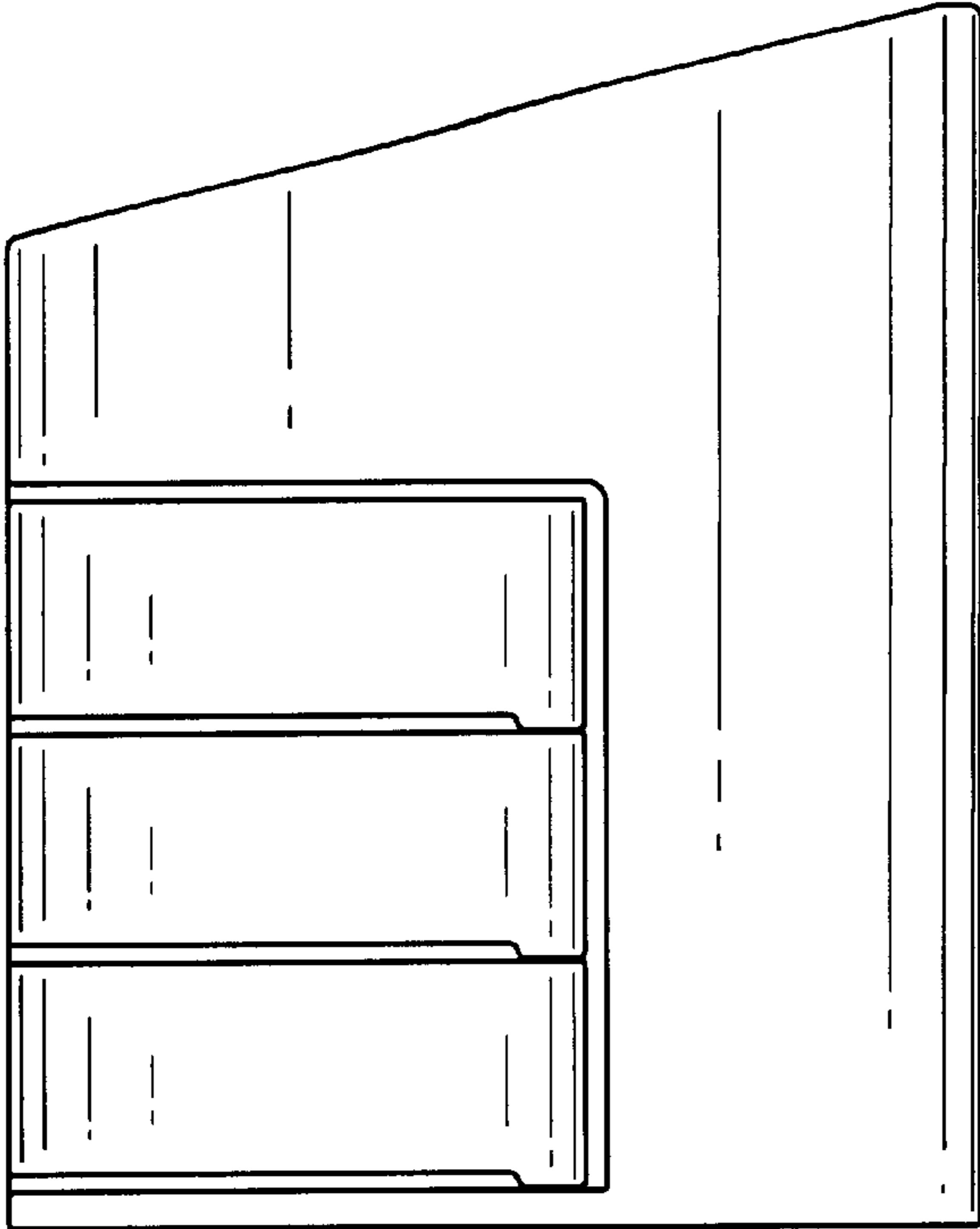
*FIG. 1*



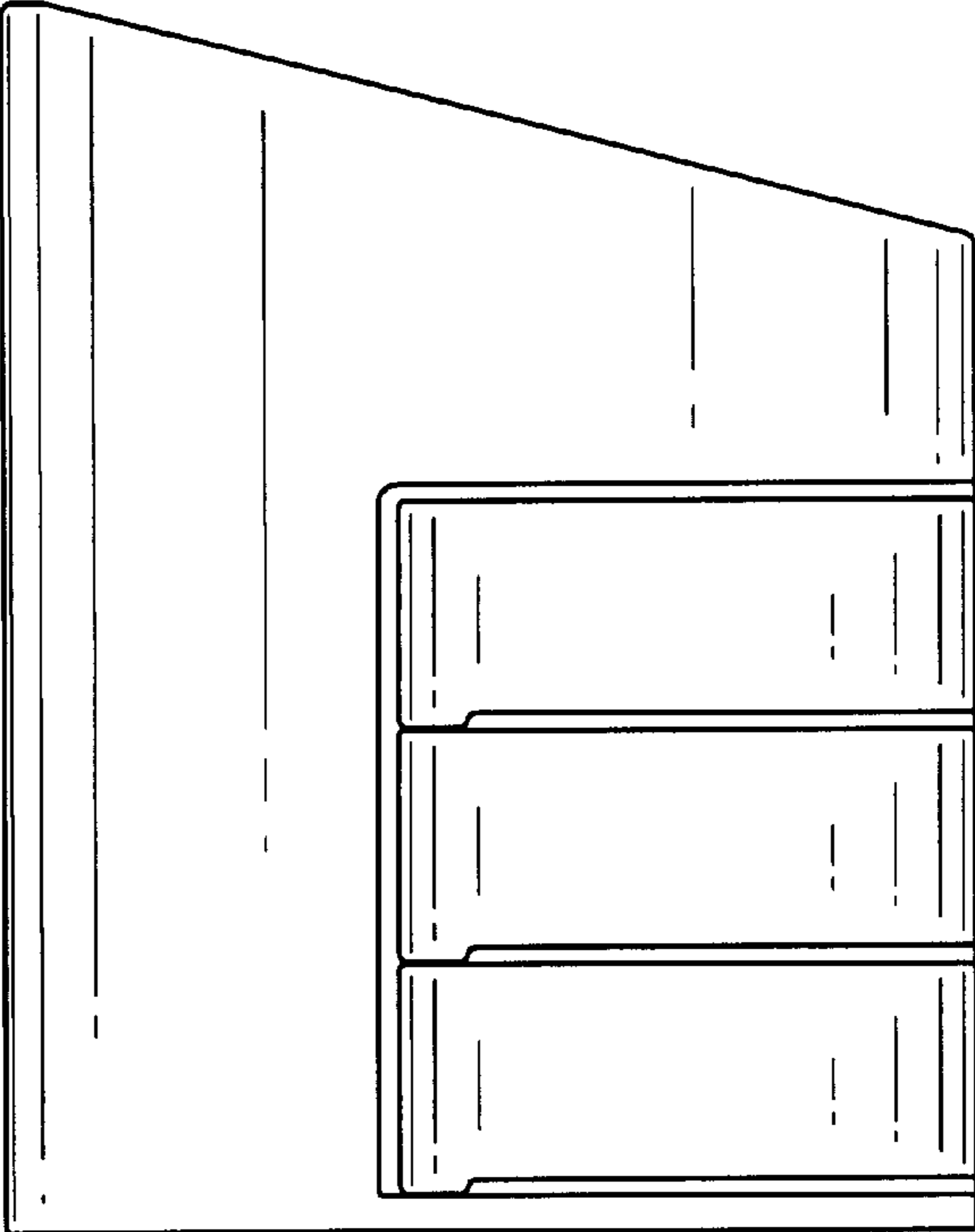
*FIG. 2*



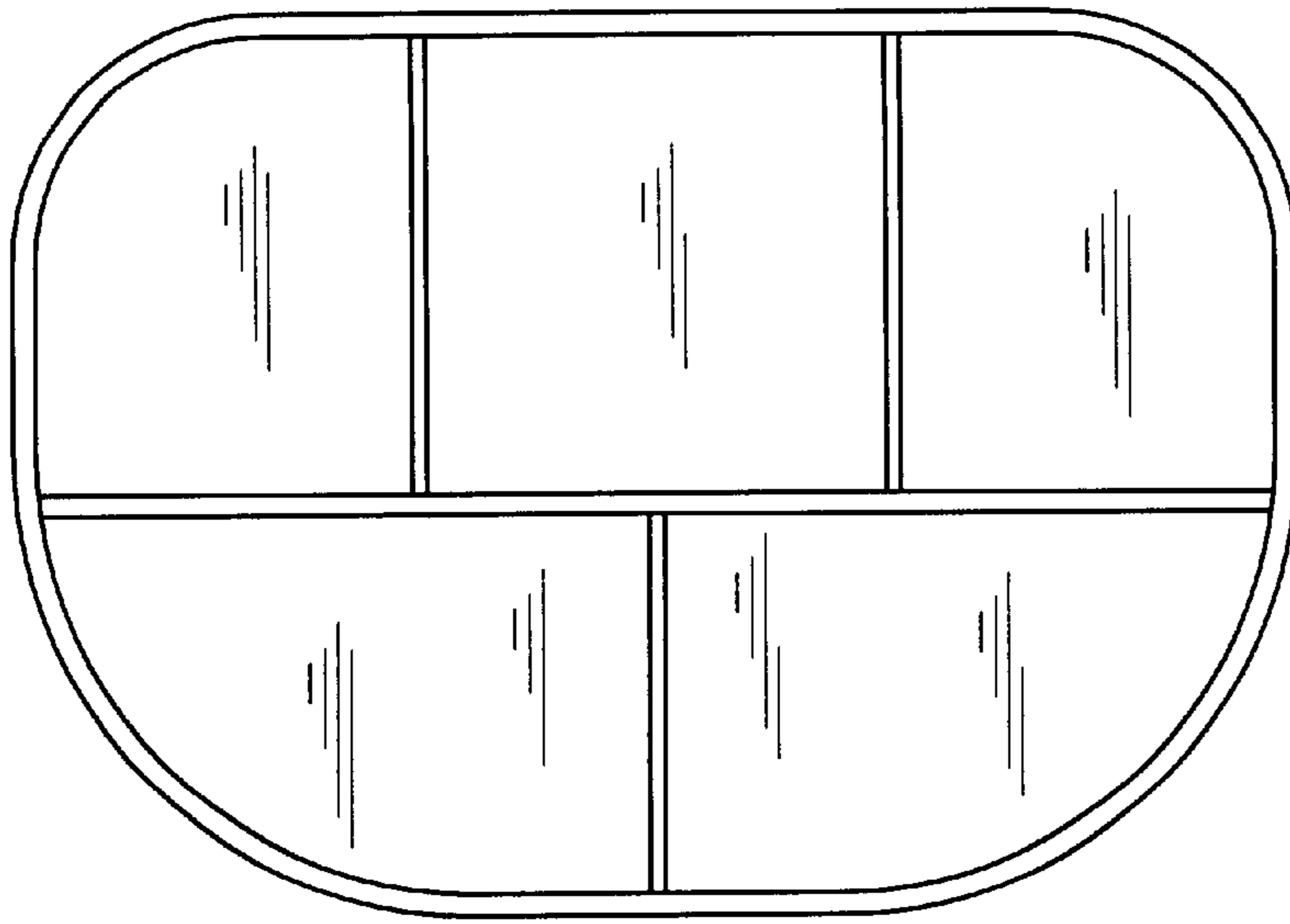
*FIG. 3*



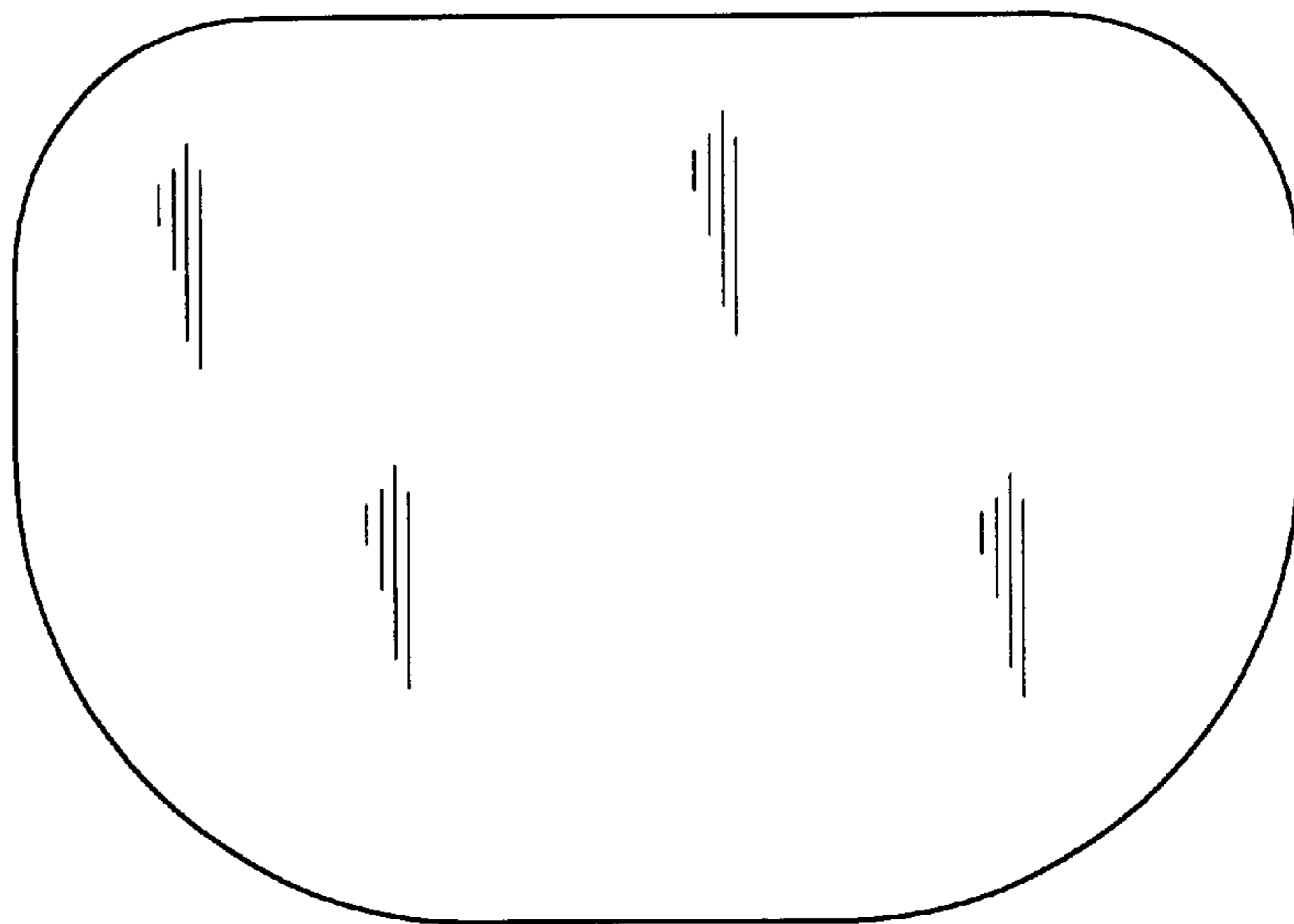
*FIG. 4*



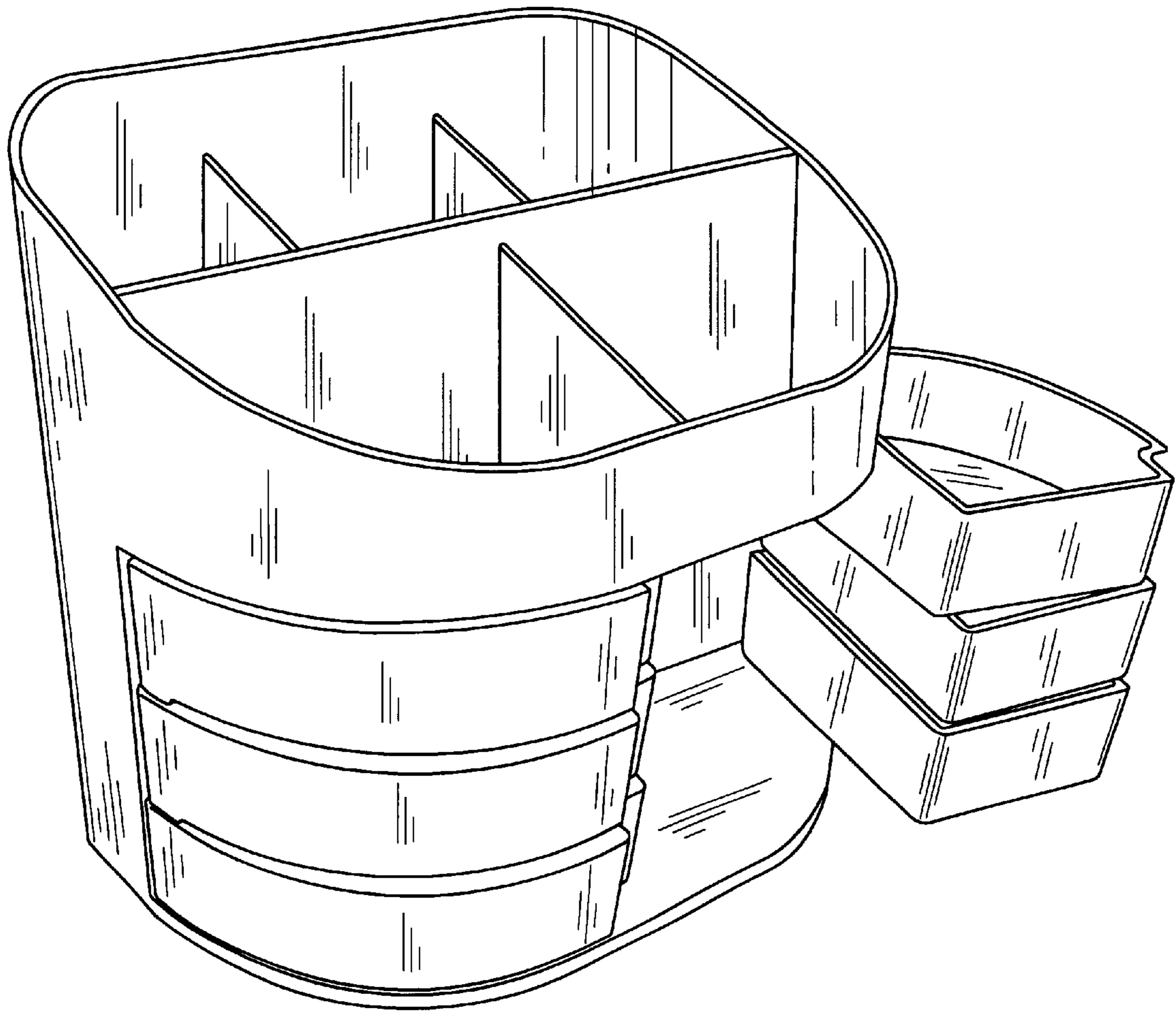
*FIG. 5*



*FIG. 6*



*FIG. 7*



*FIG. 8*



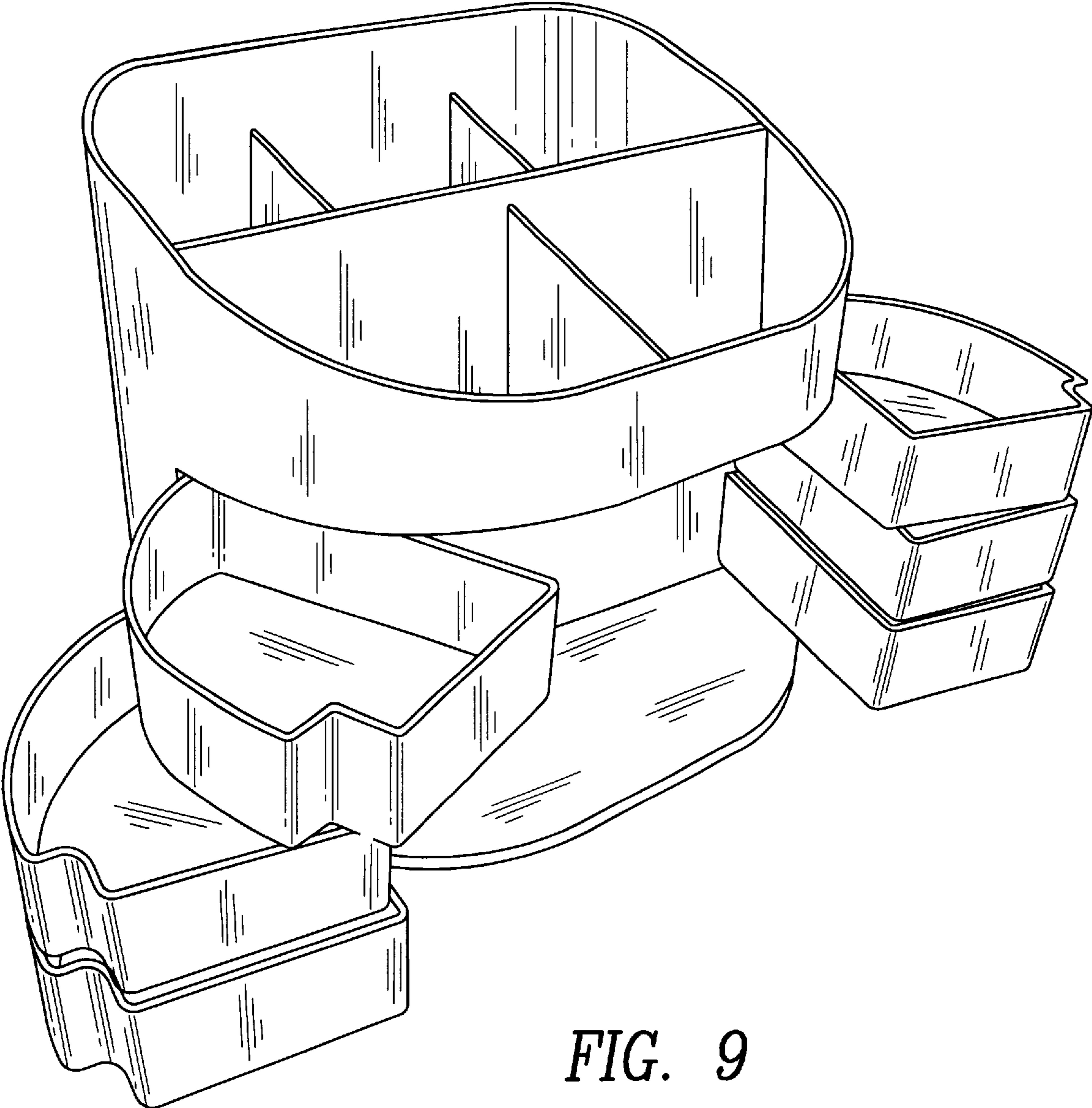


FIG. 9