



US00D510948S

(12) **United States Design Patent**
Murata et al.

(10) **Patent No.: US D510,948 S**
(45) **Date of Patent: ** Oct. 25, 2005**

(54) **COLOR PRINTER**

D492,961 S * 7/2004 Miyahara et al. D18/54

(75) Inventors: **Kazuomi Murata, Ise (JP); Haruki Takeuchi, Ise (JP); Shoji Kawase, Ise (JP)**

FOREIGN PATENT DOCUMENTS

EP 0540301 A2 * 10/1992
GB 2235904 * 10/1987

(73) Assignee: **Shinko Electric Co., Ltd., Tokyo (JP)**

* cited by examiner

(**) Term: **14 Years**

Primary Examiner—Cathy Anne MacCormac
(74) *Attorney, Agent, or Firm*—Sughrue Mion, PLLC

(21) Appl. No.: **29/186,142**

(57) **CLAIM**

(22) Filed: **Jul. 11, 2003**

The ornamental design for a color printer, as shown and described.

(30) **Foreign Application Priority Data**

Jan. 17, 2003 (JP) 2003-001080

DESCRIPTION

(51) **LOC (8) Cl. 14-02**
(52) **U.S. Cl. D18/50**
(58) **Field of Search D18/19, 36-41, D18/50, 53, 54, 54.1, 55; D14/420-425, 462-470, 349; 400/613, 613.1, 613.4, 690.1-690.4, 691-694**

FIG. 1 perspective view of the top, front and right side of a color printer showing our new design;
FIG. 2 is a front elevational view thereof;
FIG. 3 is a top plan view thereof;
FIG. 4 is a right side elevational view thereof;
FIG. 5 is a left side elevational view thereof;
FIG. 6 is a rear elevational view thereof;
FIG. 7 is a bottom plan view thereof;
FIG. 8 is a perspective view with covers in the open position;
FIG. 9 is a front elevational view of FIG. 8;
FIG. 10 is a top plan view of FIG. 8;
FIG. 11 is a right side elevational view of FIG. 8;
FIG. 12 is a left side elevational view of FIG. 8;
FIG. 13 is a rear elevational view of FIG. 8; and,
FIG. 14 is a bottom plan view of FIG. 8.

(56) **References Cited**

U.S. PATENT DOCUMENTS

5,028,935 A * 7/1991 Warmack et al. D18/55
5,387,043 A * 2/1995 Fujioka et al. 400/691
D390,202 S * 2/1998 Goto D14/349
D442,987 S * 5/2001 Ikenaga D18/50
6,572,290 B2 * 6/2003 McCleave et al. 400/613
D491,218 S * 6/2004 Masamitsu et al. D18/50
D492,719 S * 7/2004 Schmitt et al. D18/50

1 Claim, 14 Drawing Sheets

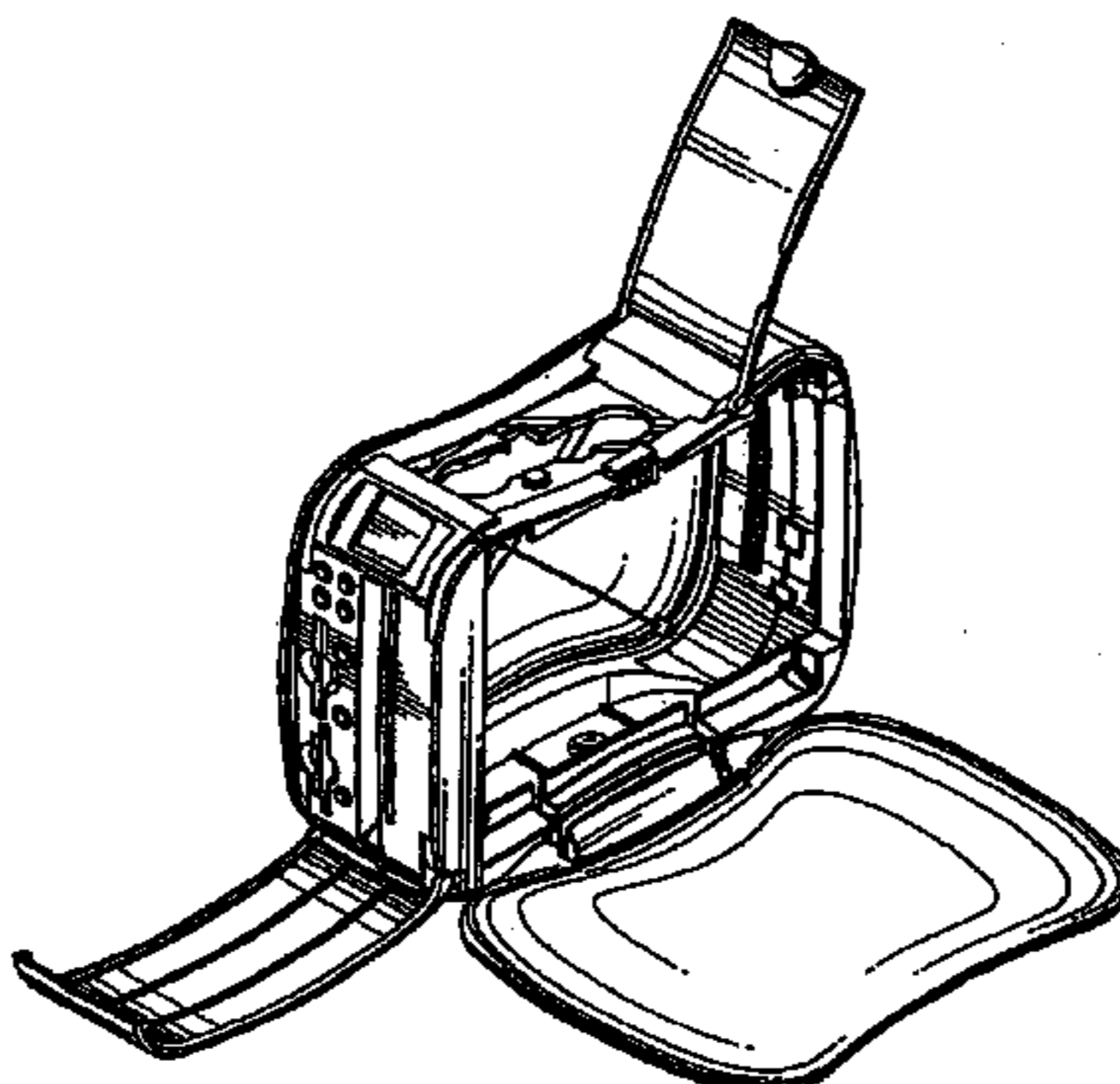
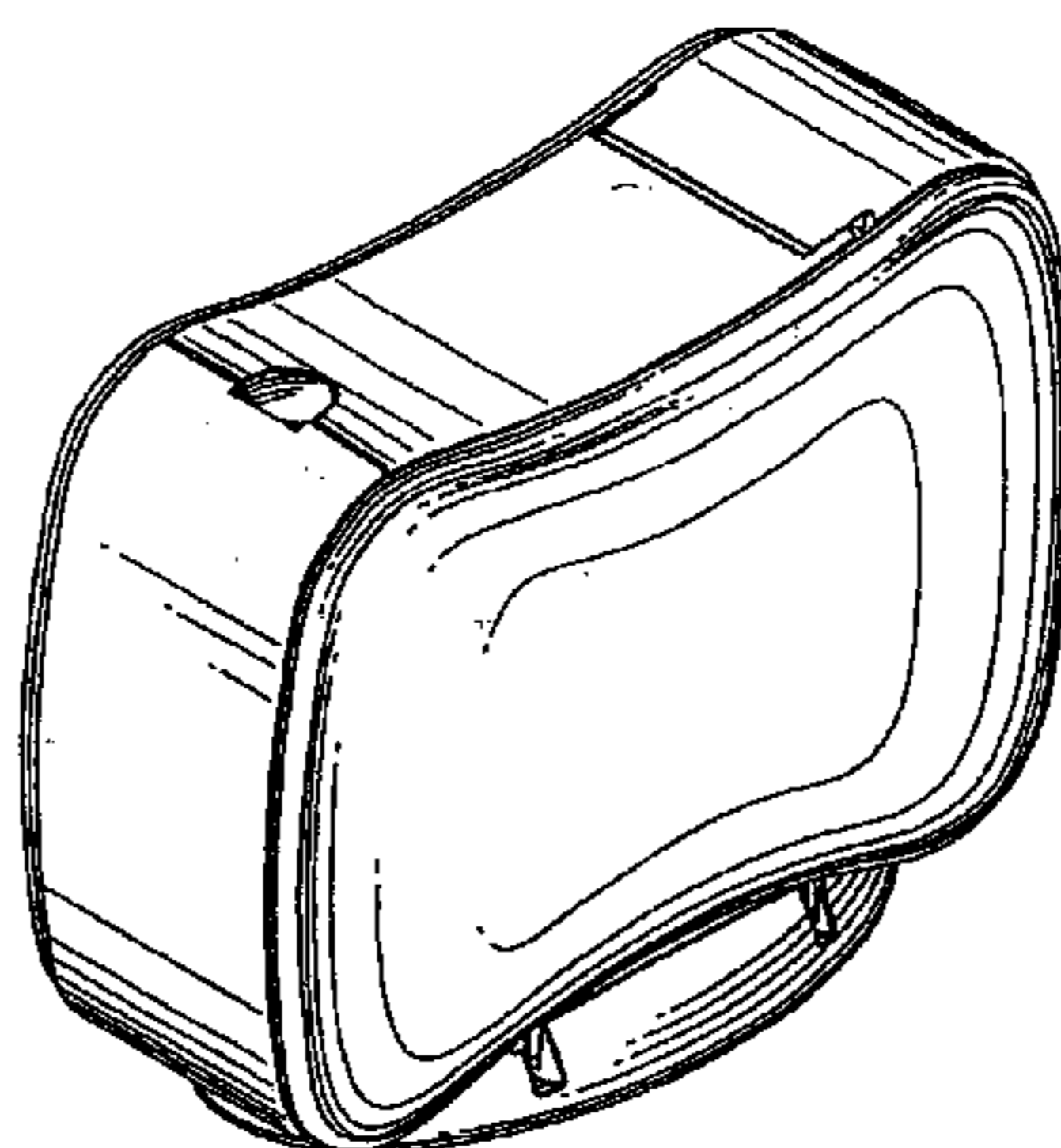

Fig. 1

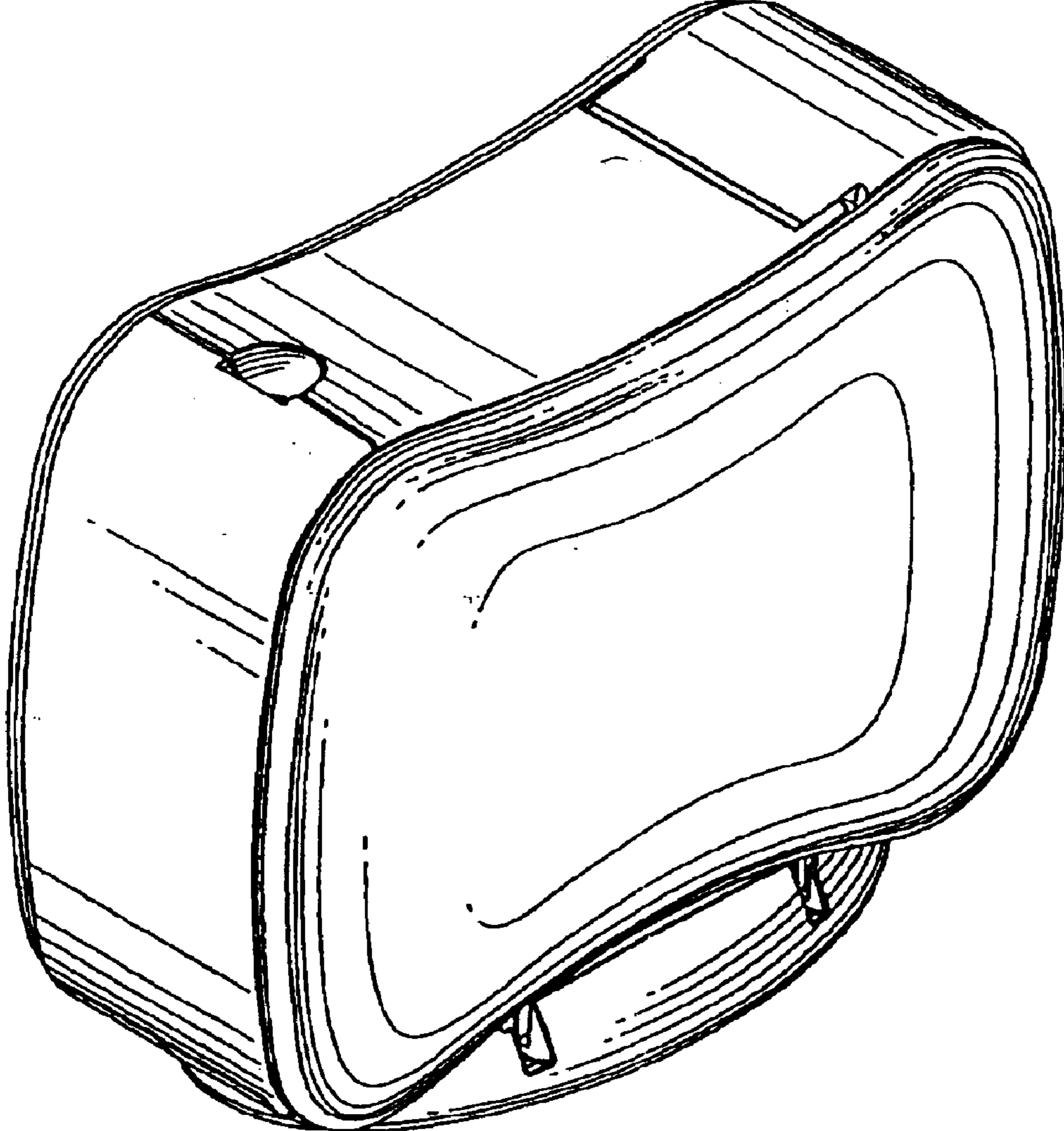

Fig.2

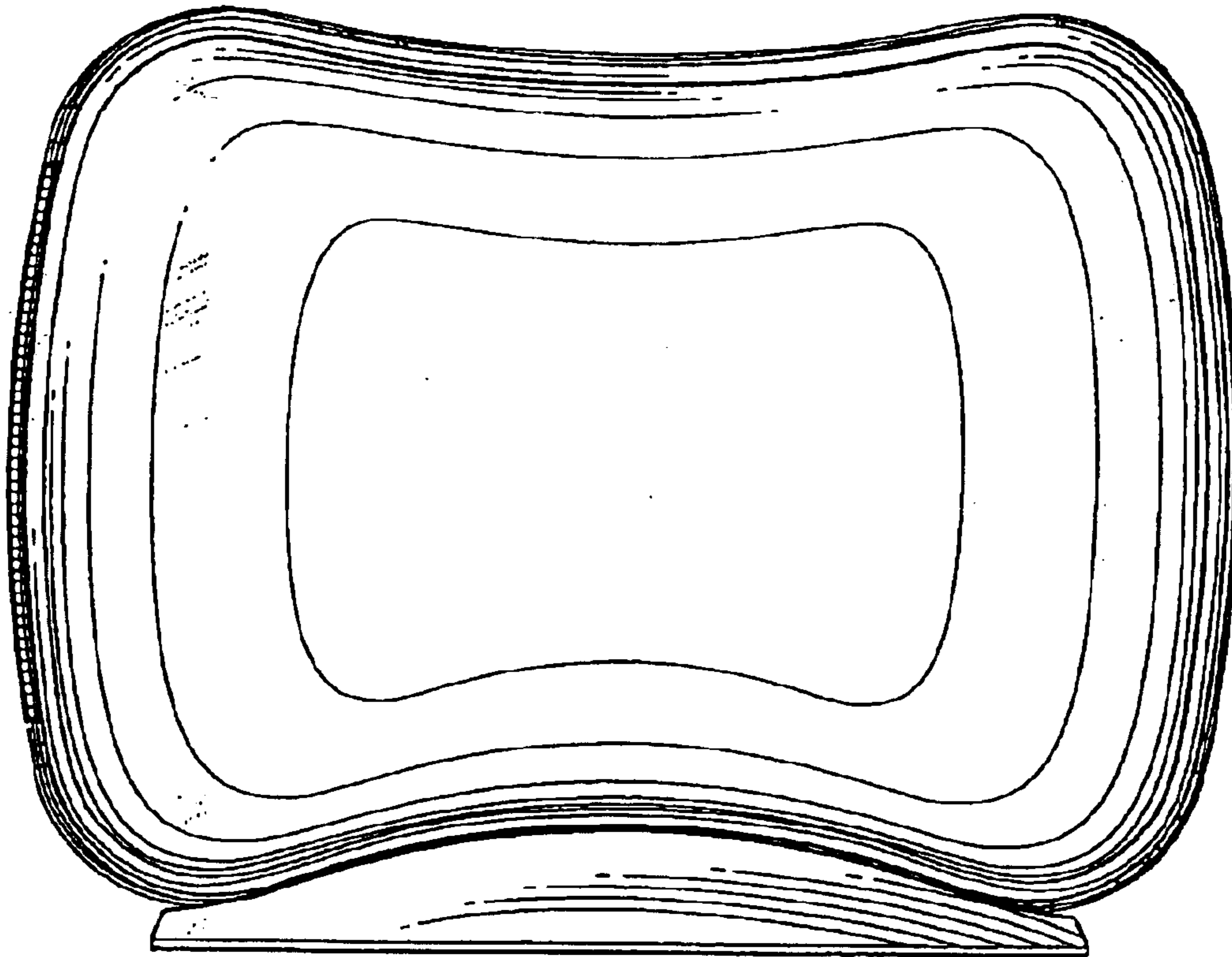

Fig.3

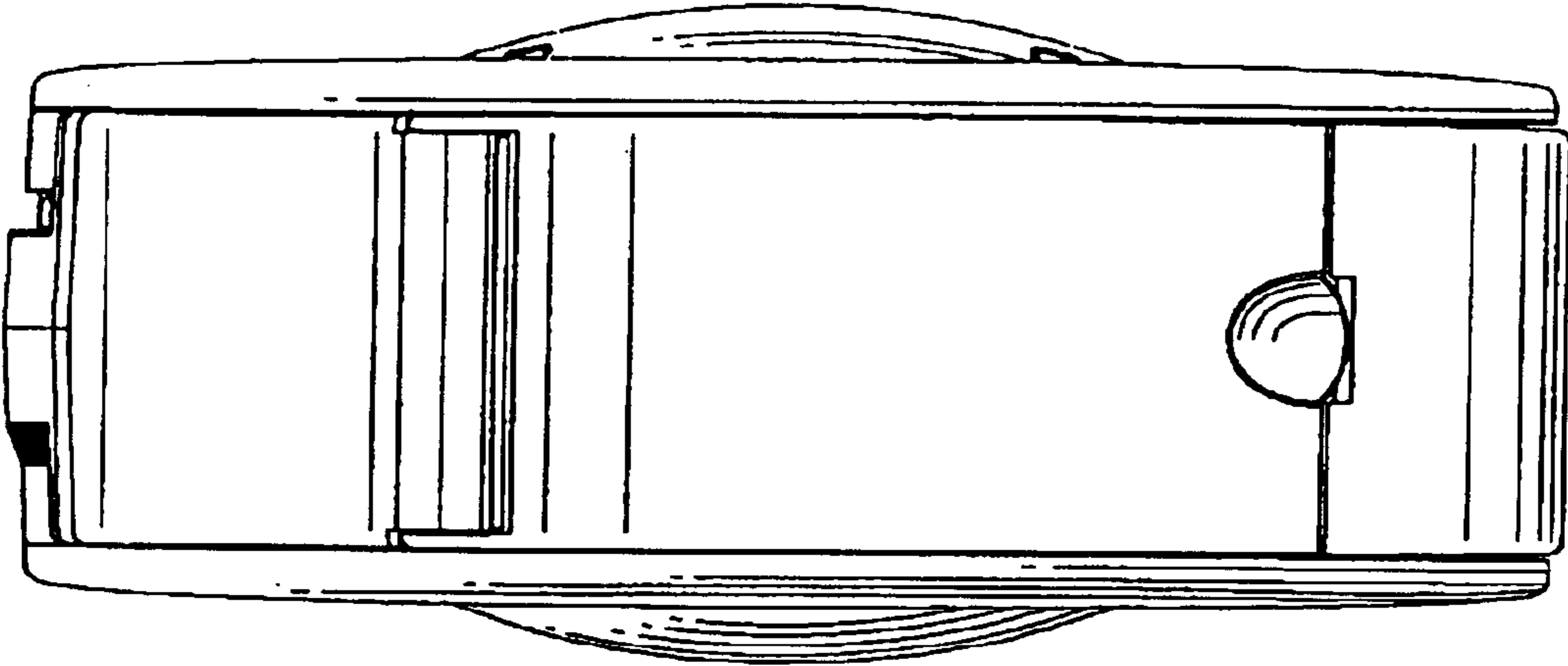

Fig. 4

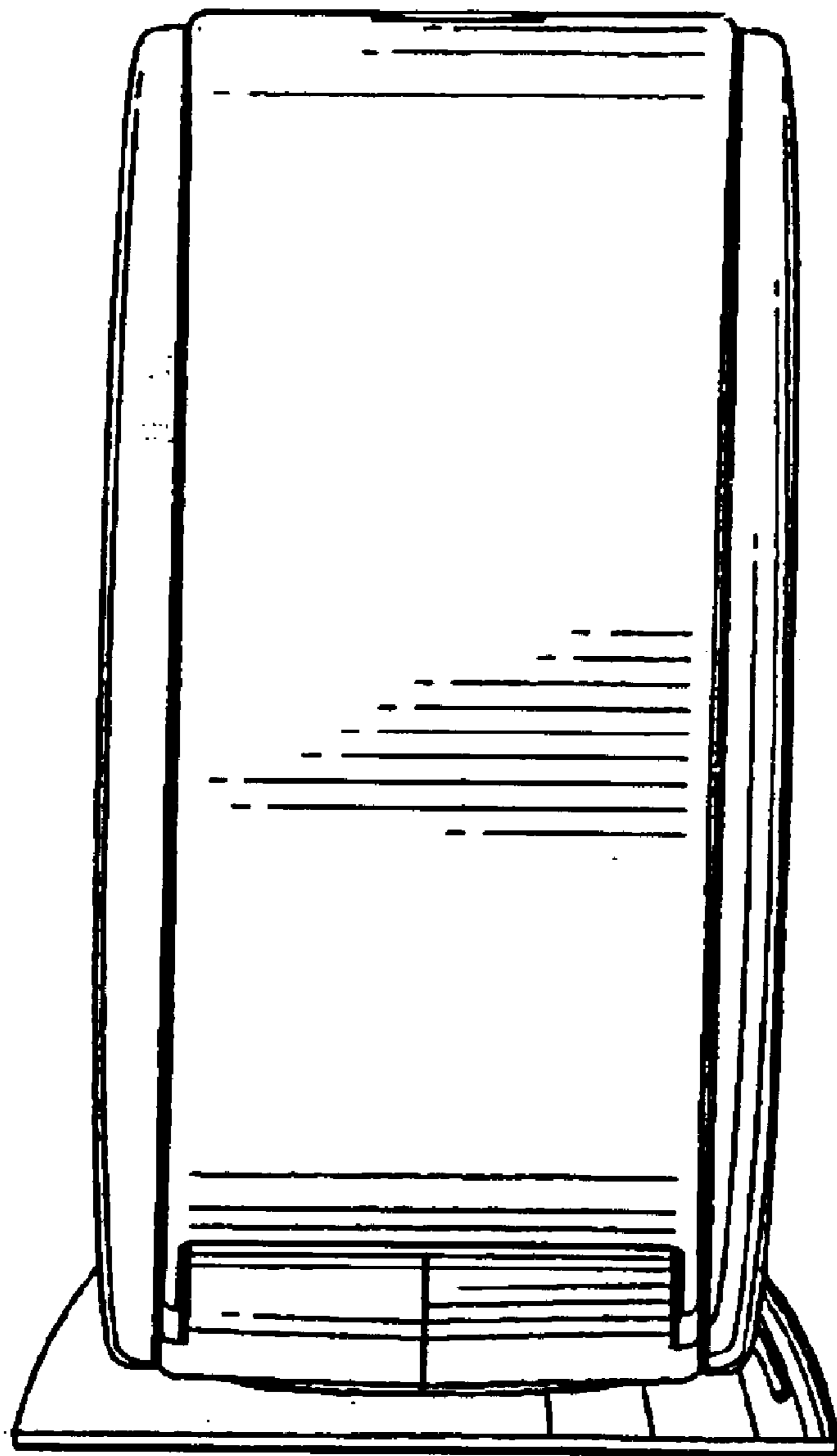

Fig.5

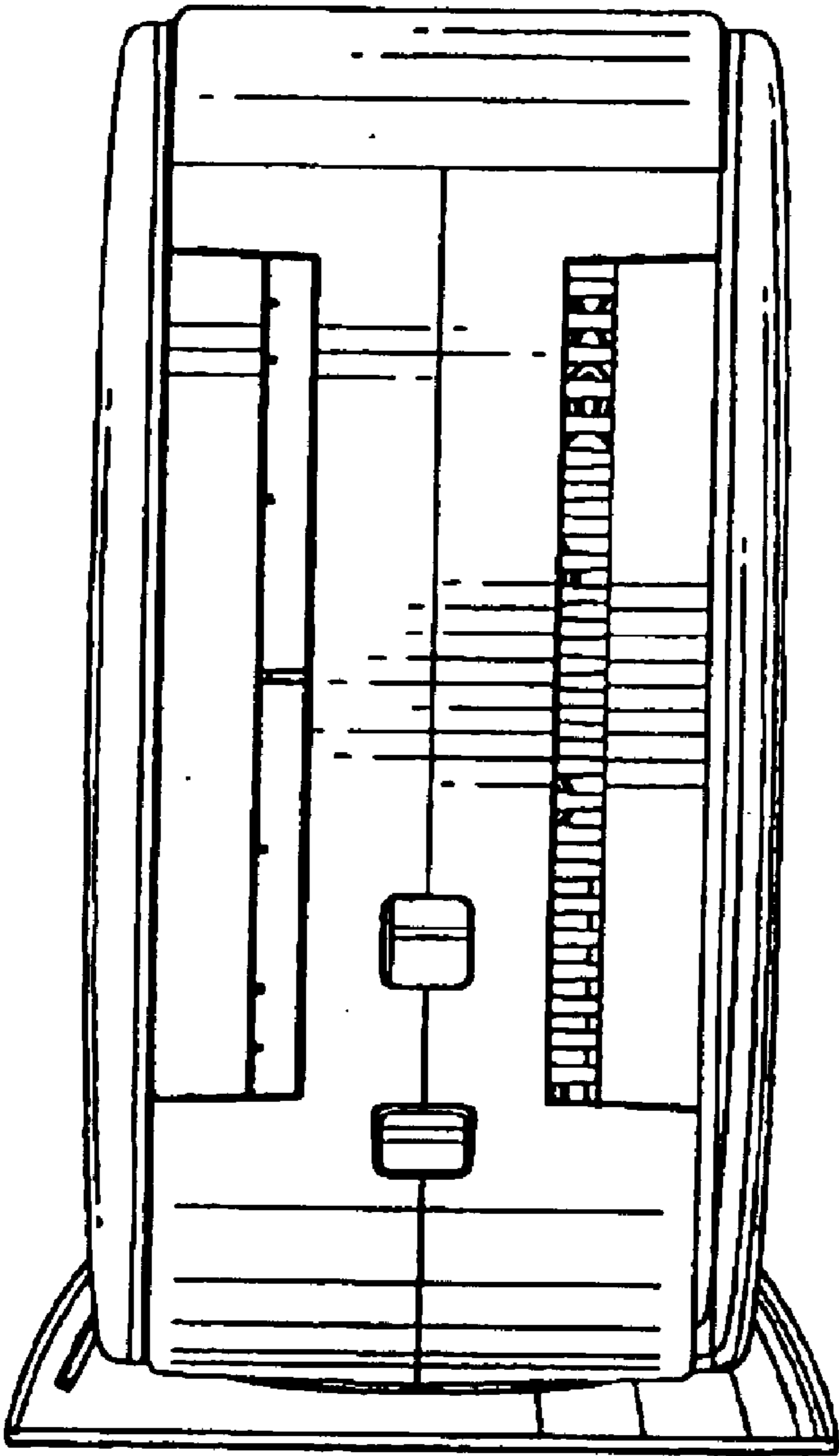

Fig.6

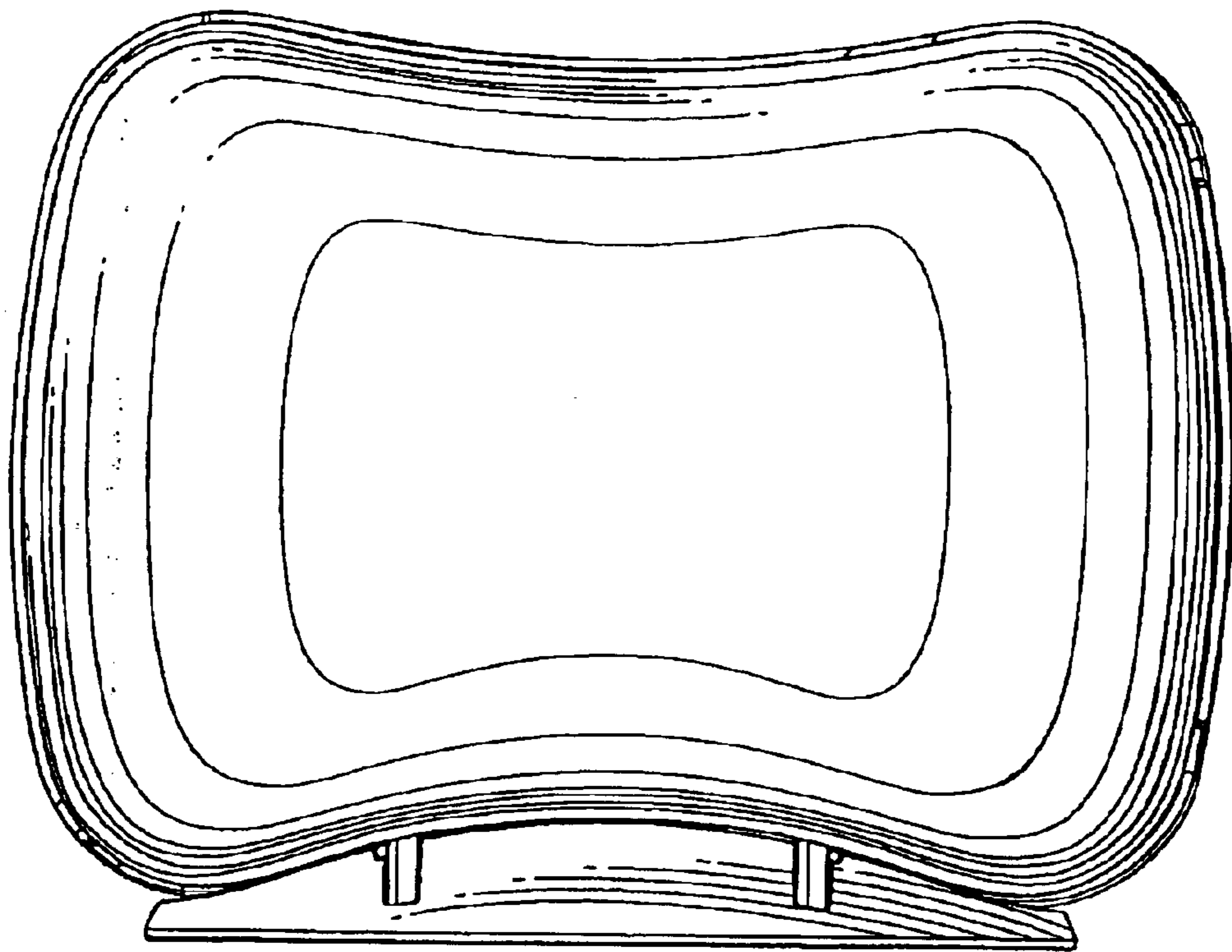

Fig.7

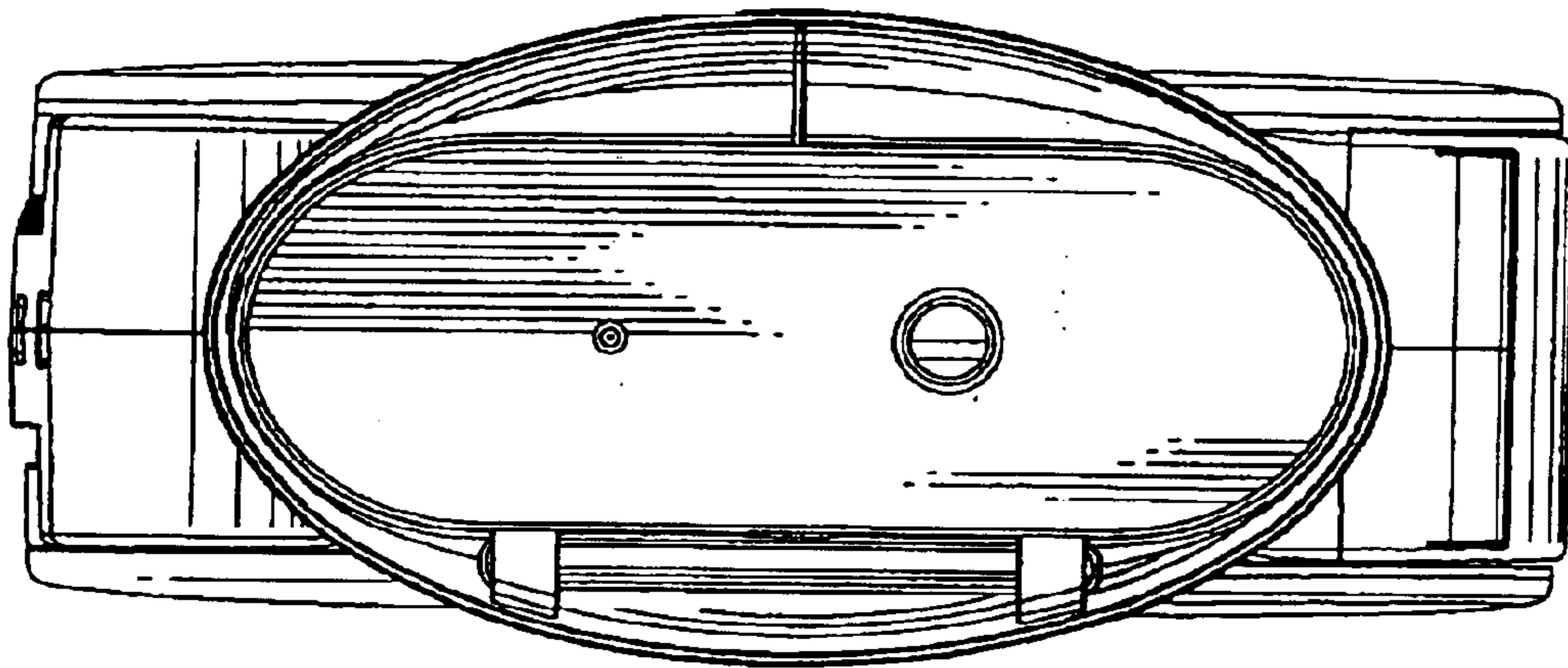

Fig. 8

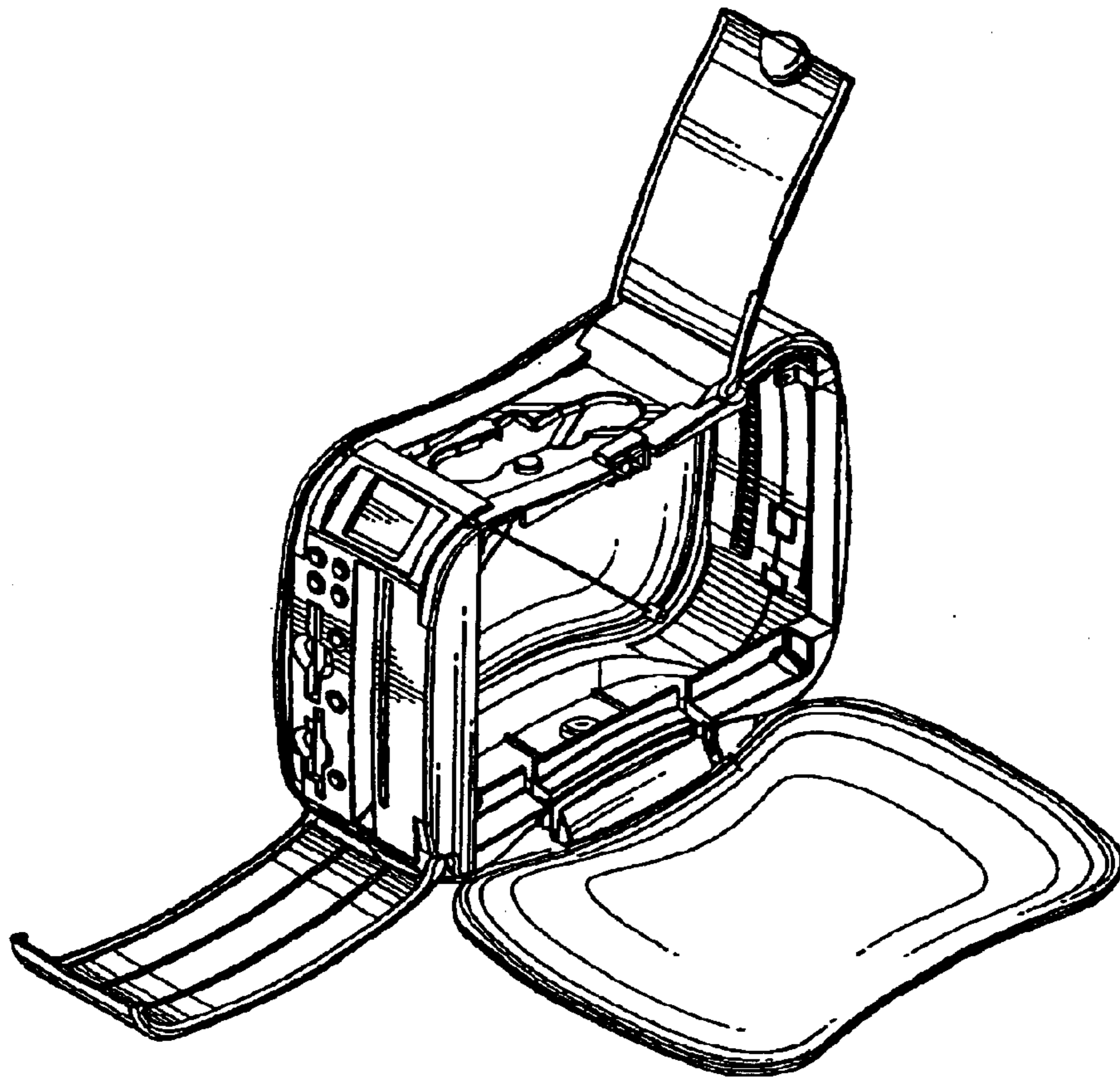

Fig. 9

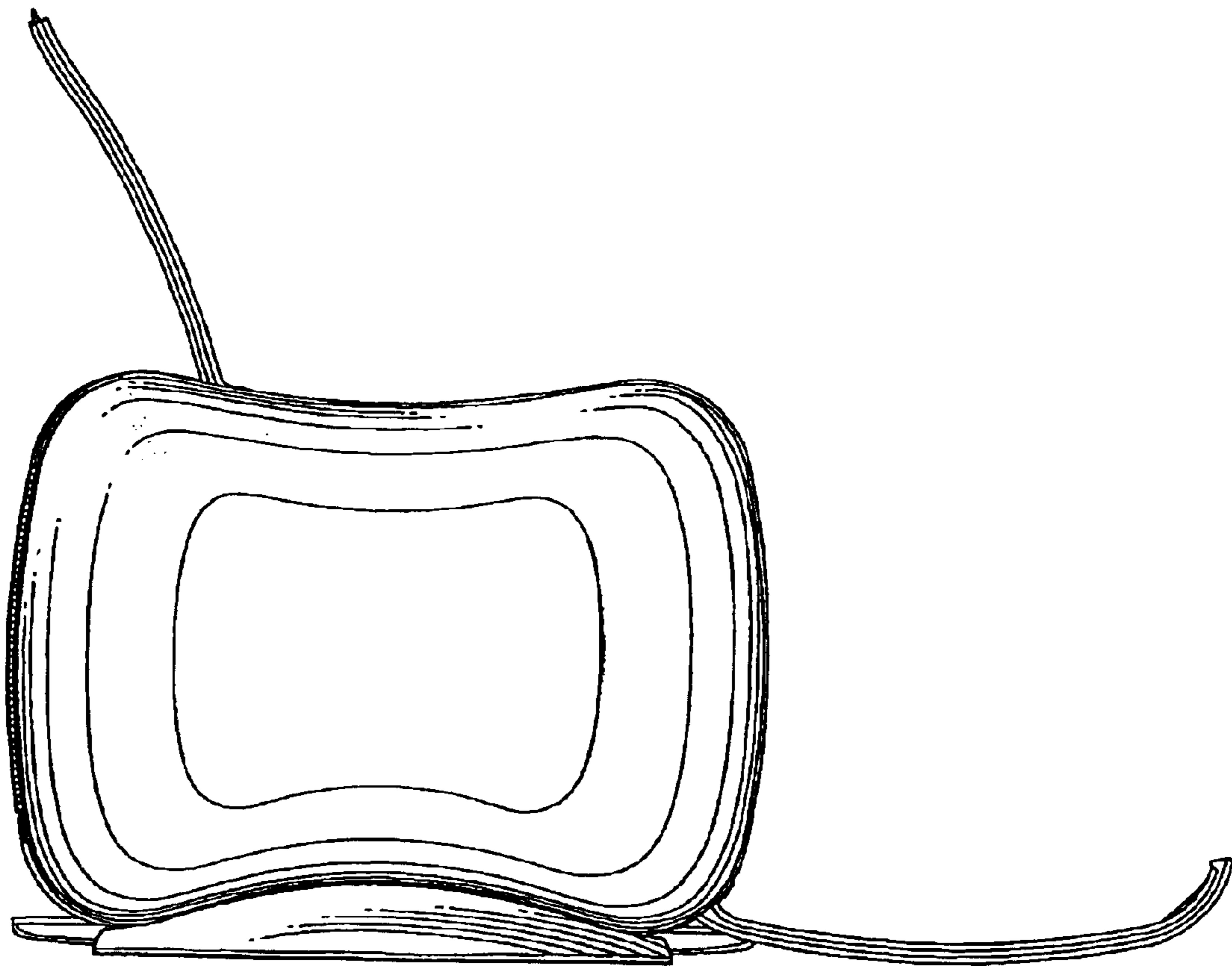

Fig. 10

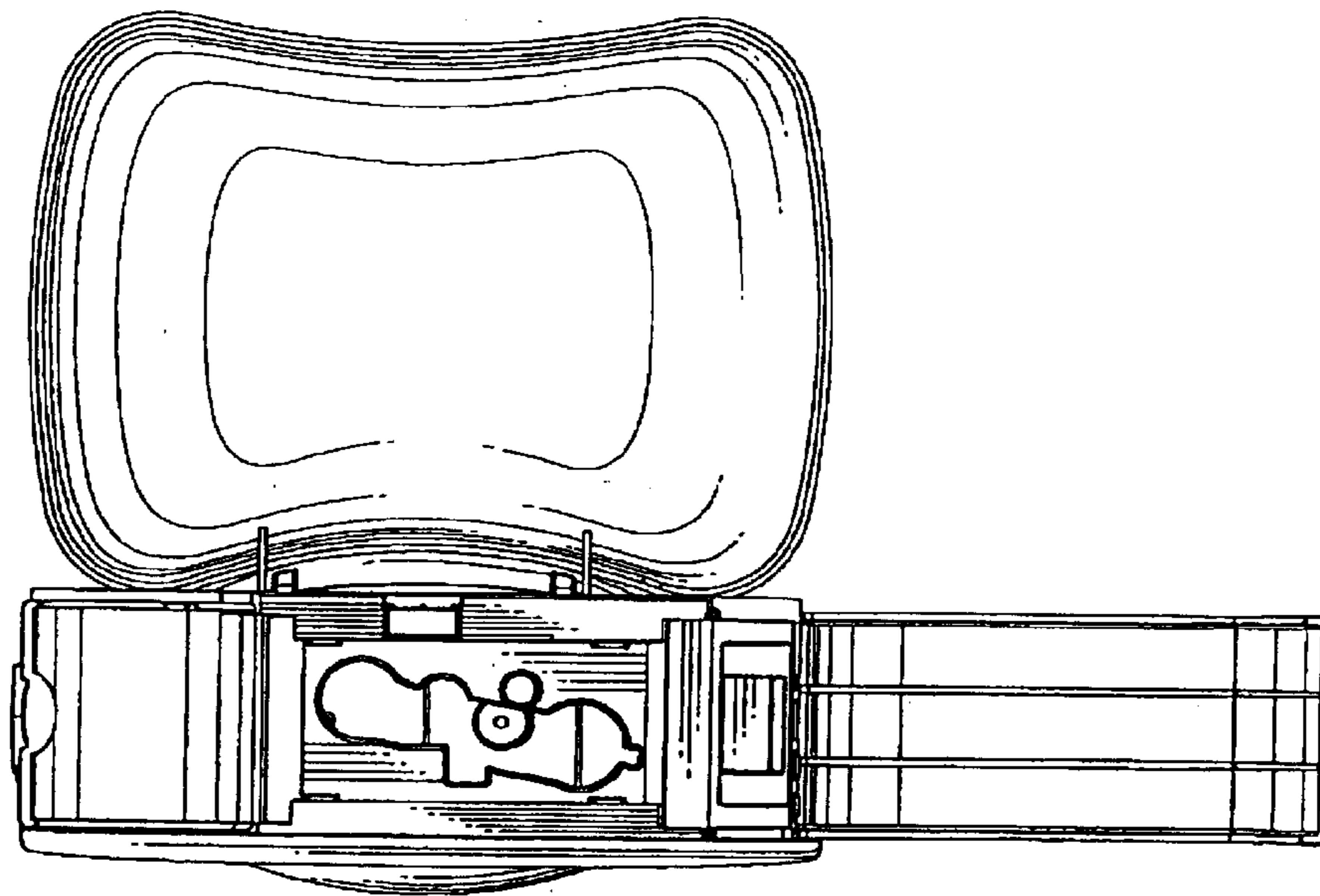

Fig. 11

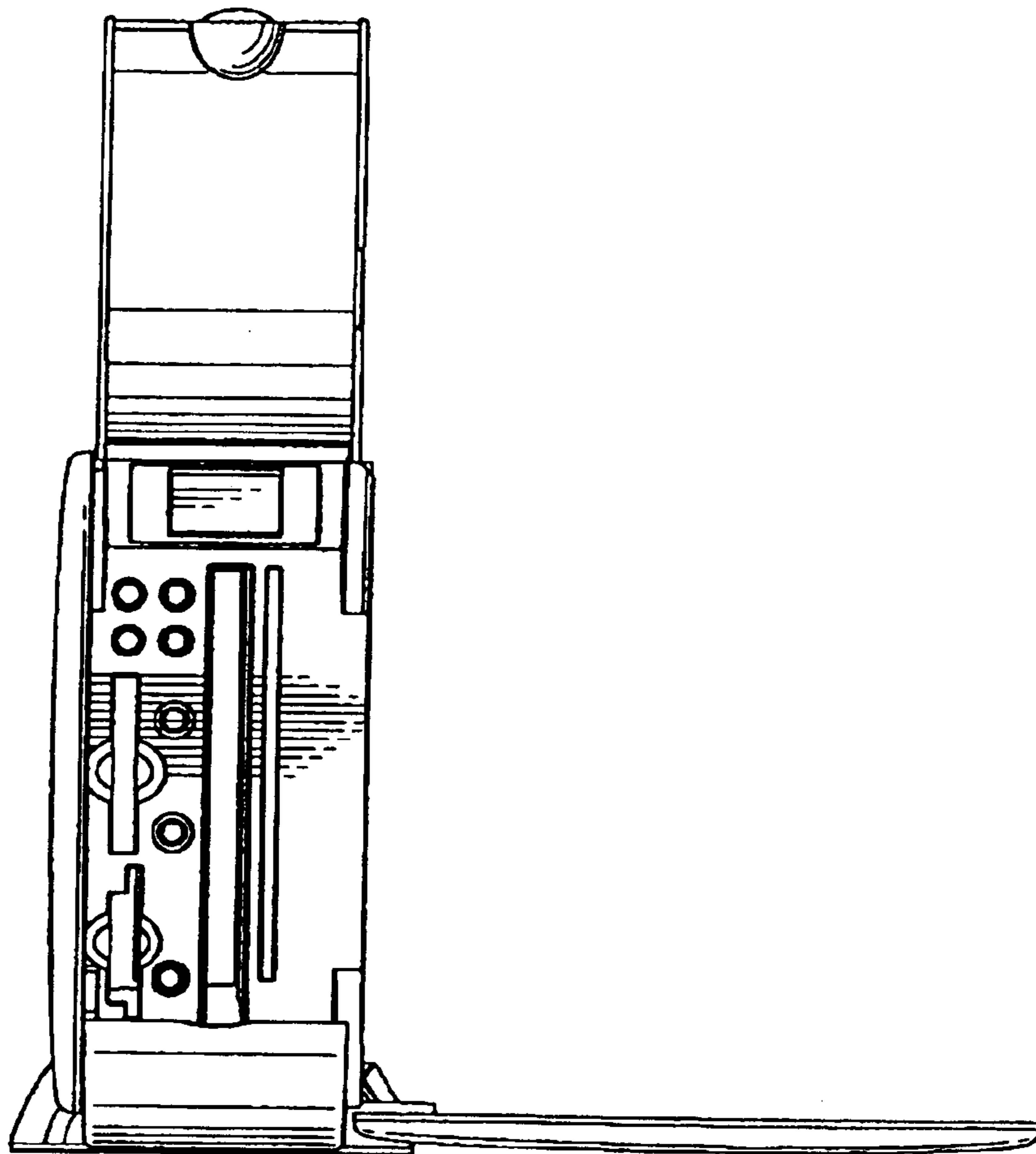

Fig. 12

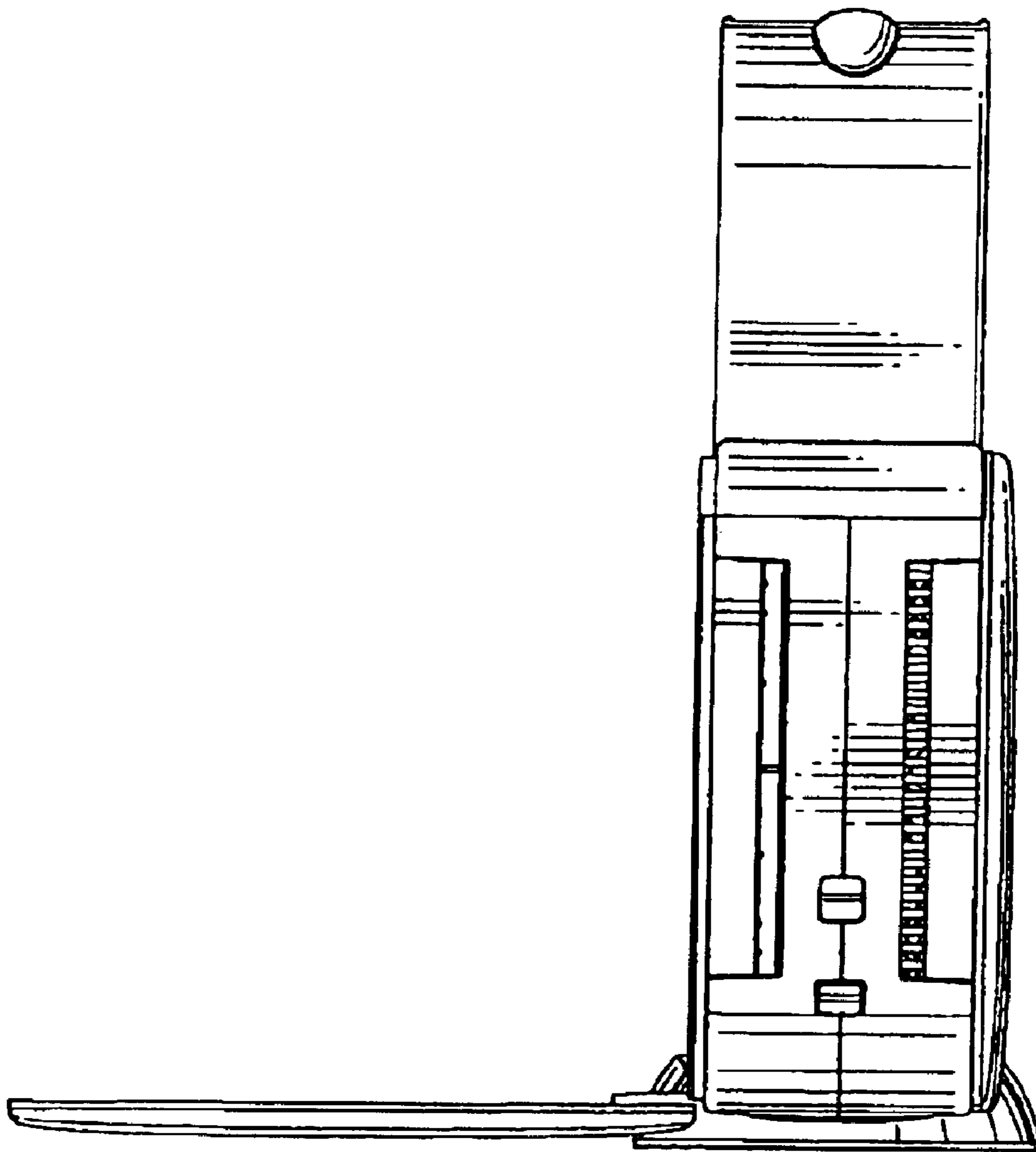

Fig. 13

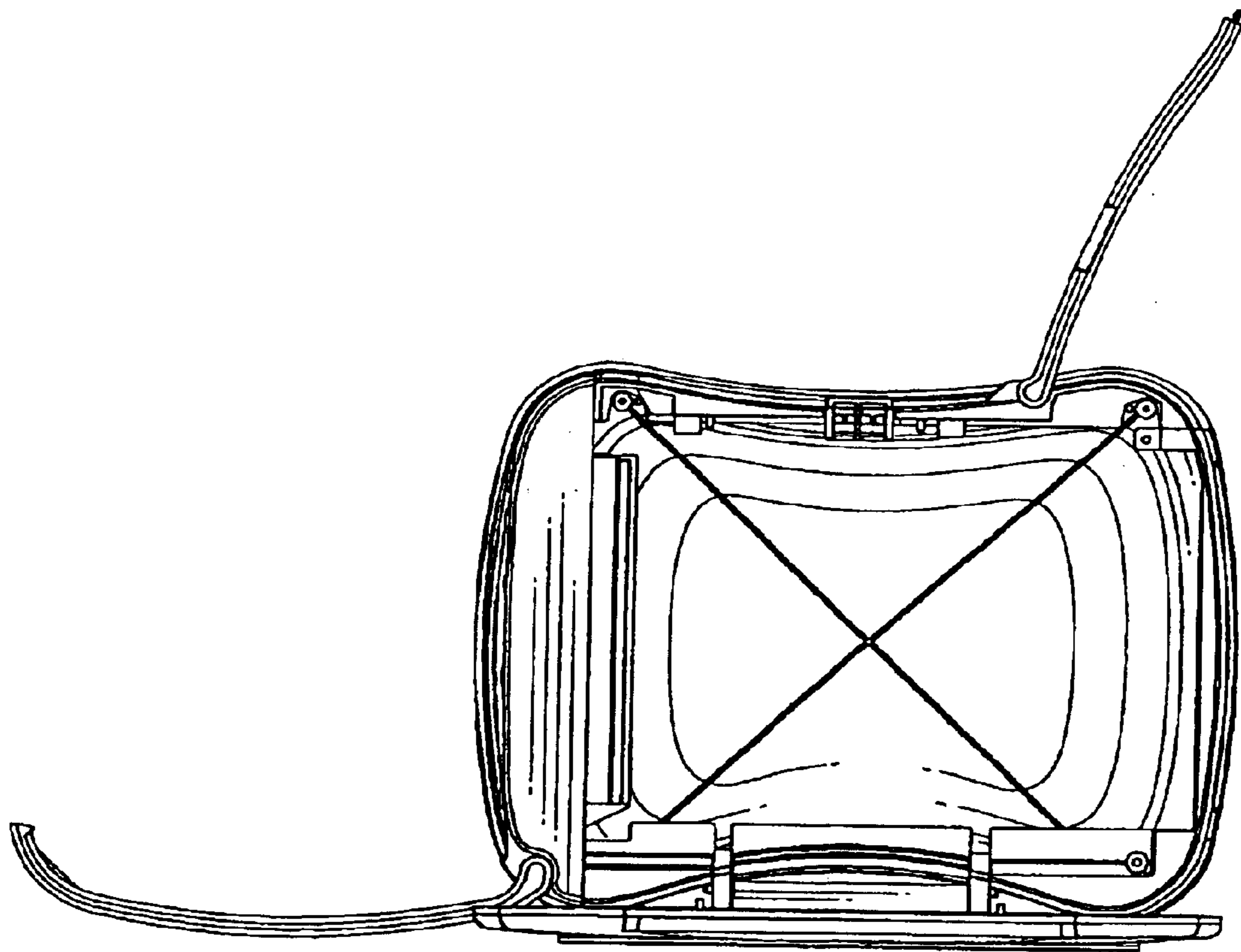

Fig. 14

