



US00D510925S

(12) **United States Design Patent** (10) **Patent No.:** **US D510,925 S**
Ueno (45) **Date of Patent:** **** Oct. 25, 2005**

(54) **DIGITAL VIDEO DISC RECORDER**

JP 1163996 1/2003

(75) Inventor: **Shogo Ueno**, Tokyo (JP)

OTHER PUBLICATIONS

(73) Assignee: **Pioneer Corporation**, Tokyo (JP)

Catalogue of Pioneer Corporation issued Jan. 2000.
Catalogue of Pioneer Corporation issued Feb. 2001.
Catalogue of Pioneer Corporation issued Mar. 2003.
Catalogue of Pioneer Corporation issued Mar.–Apr. 2000.

(**) Term: **14 Years**

* cited by examiner

(21) Appl. No.: **29/183,519**

(22) Filed: **Jun. 13, 2003**

Primary Examiner—Nanda Bondade

(30) **Foreign Application Priority Data**

(74) *Attorney, Agent, or Firm*—Sughrue Mion, PLLC

Mar. 14, 2003 (JP) 2003-006739

(57) **CLAIM**

(51) **LOC (8) Cl.** **14-01**

The ornamental design for a digital video disc recorder, as shown and described.

(52) **U.S. Cl.** **D14/156**

(58) **Field of Search** D14/135–136,
D14/156–157, 160–165, 167–168, 188,
193–198; 369/75.1, 75.2, 77.1, 77.2; 455/344,
347–351

DESCRIPTION

(56) **References Cited**

U.S. PATENT DOCUMENTS

D442,933 S * 5/2001 Sawai D14/156
D451,488 S * 12/2001 Foster D14/156
D461,788 S * 8/2002 Oka D14/168
D467,563 S * 12/2002 Matsuoka D14/136
D467,893 S * 12/2002 Yamada D14/167
D470,470 S * 2/2003 Yamada et al. D14/167

FIG. 1 is a front elevational view thereof of a digital video disc recorder showing my new design;
FIG. 2 is a rear elevational view thereof;
FIG. 3 is a right side elevational view thereof;
FIG. 4 is a left side elevational view thereof;
FIG. 5 is a left top plan view thereof;
FIG. 6 is a bottom plan view thereof;
FIG. 7 is a perspective view of the top, front and right side elevational view thereof; and,
FIG. 8 is a perspective view similar to FIG. 7 with the disc holder extended.

FOREIGN PATENT DOCUMENTS

JP 1147548 7/2002

1 Claim, 3 Drawing Sheets

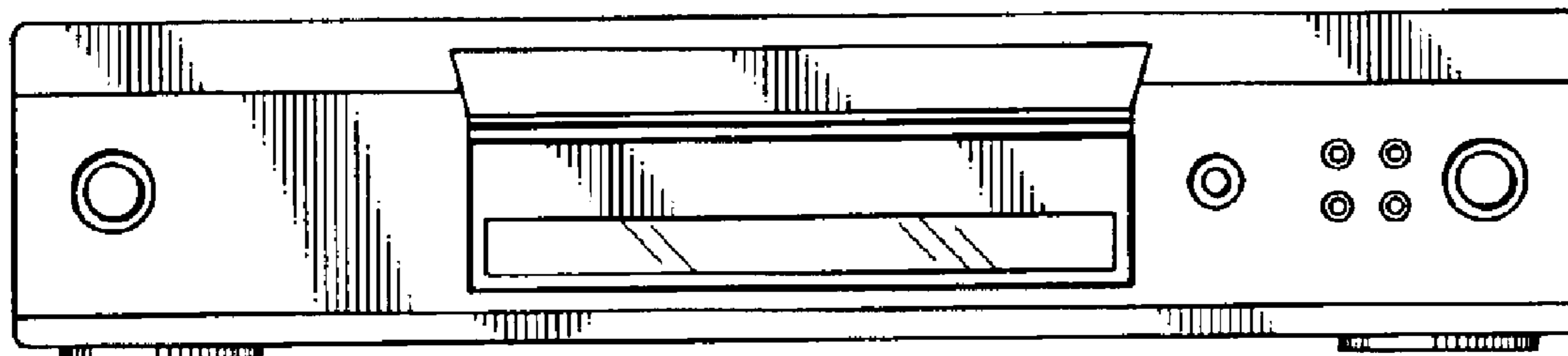

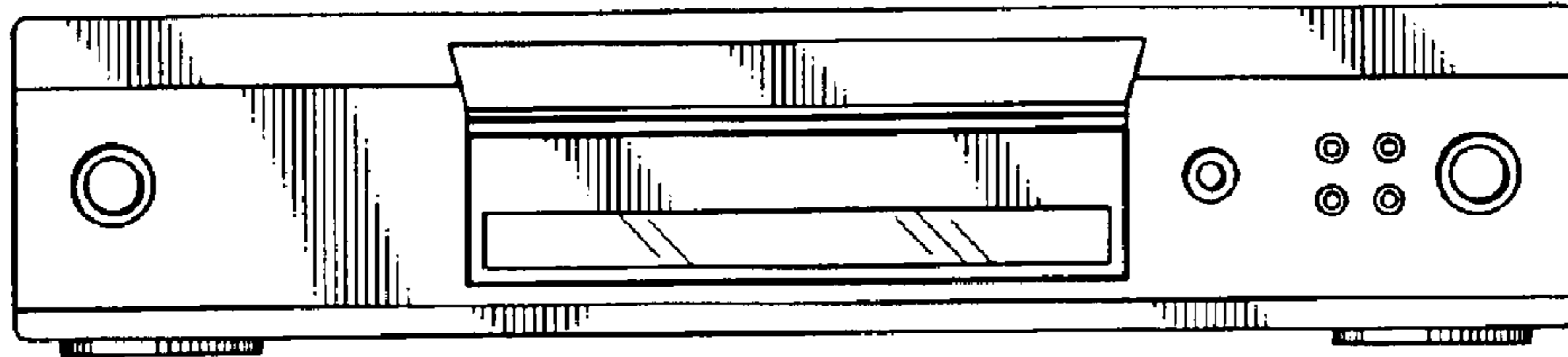

FIG. 1

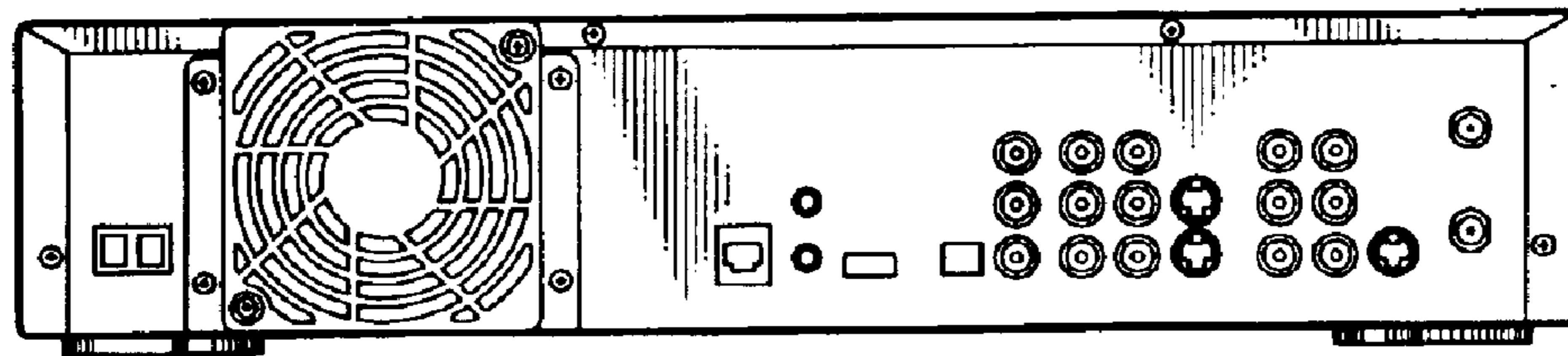

FIG. 2

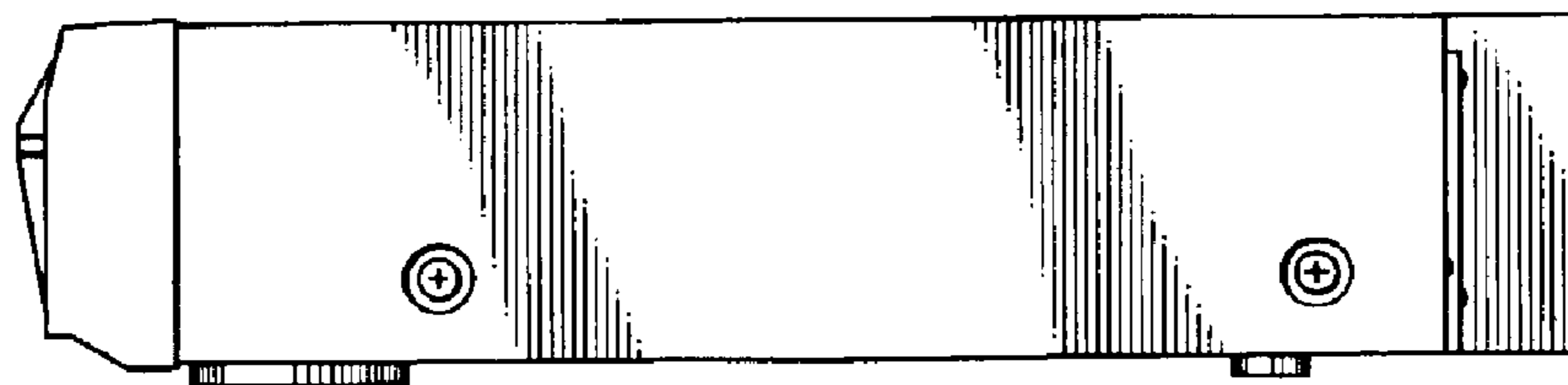

FIG. 3

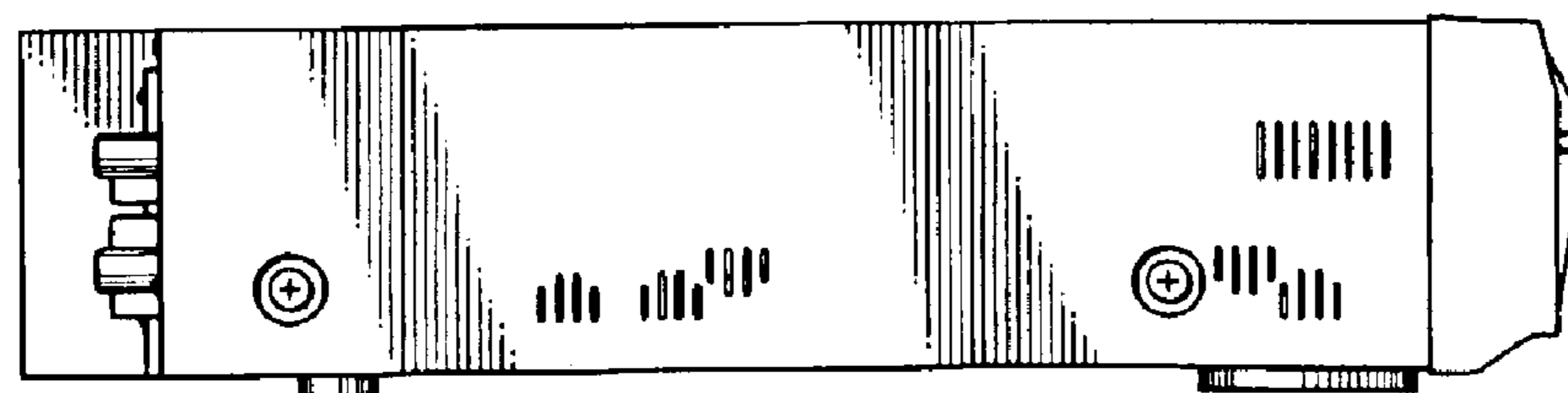

FIG. 4

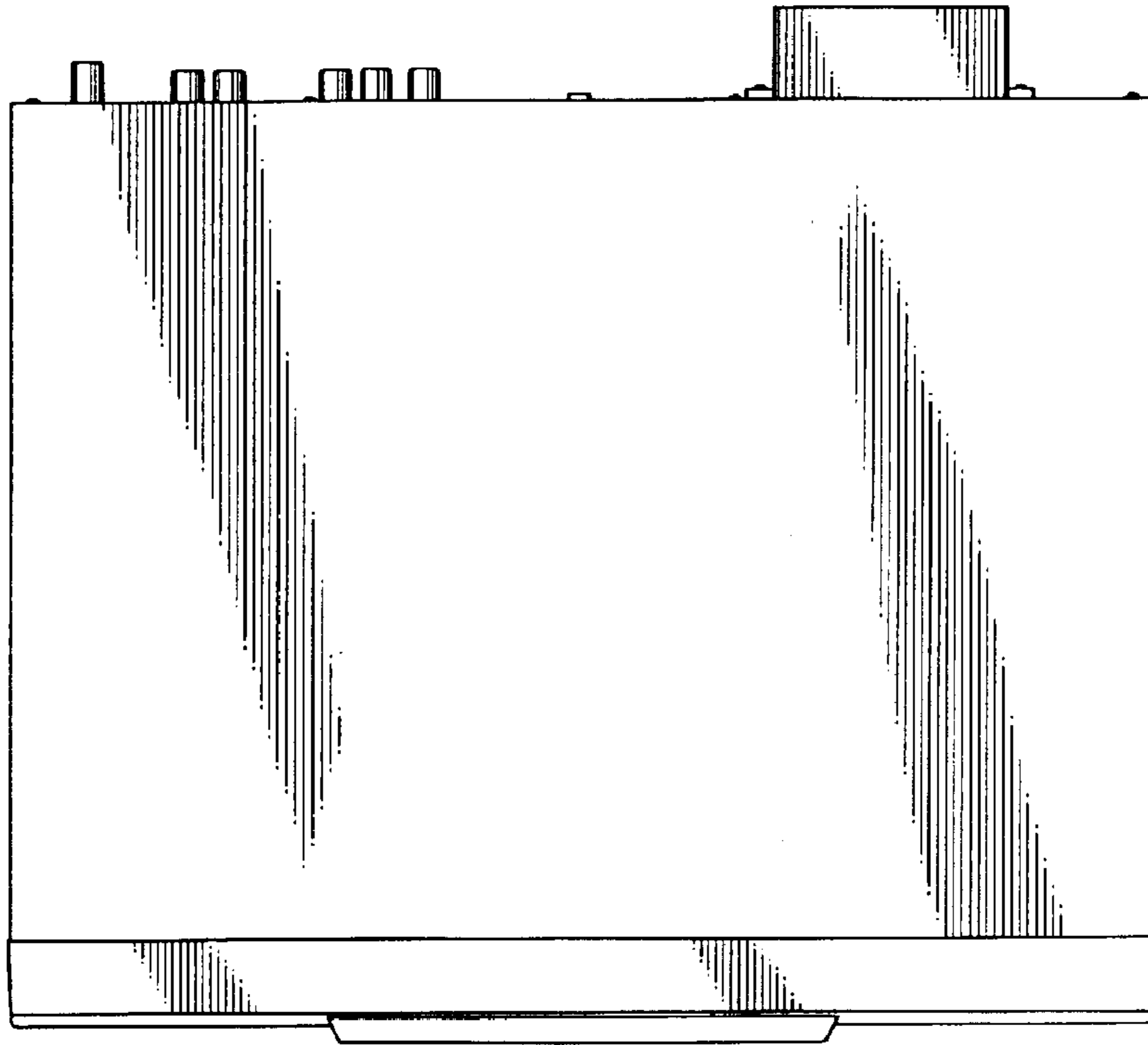

FIG. 5

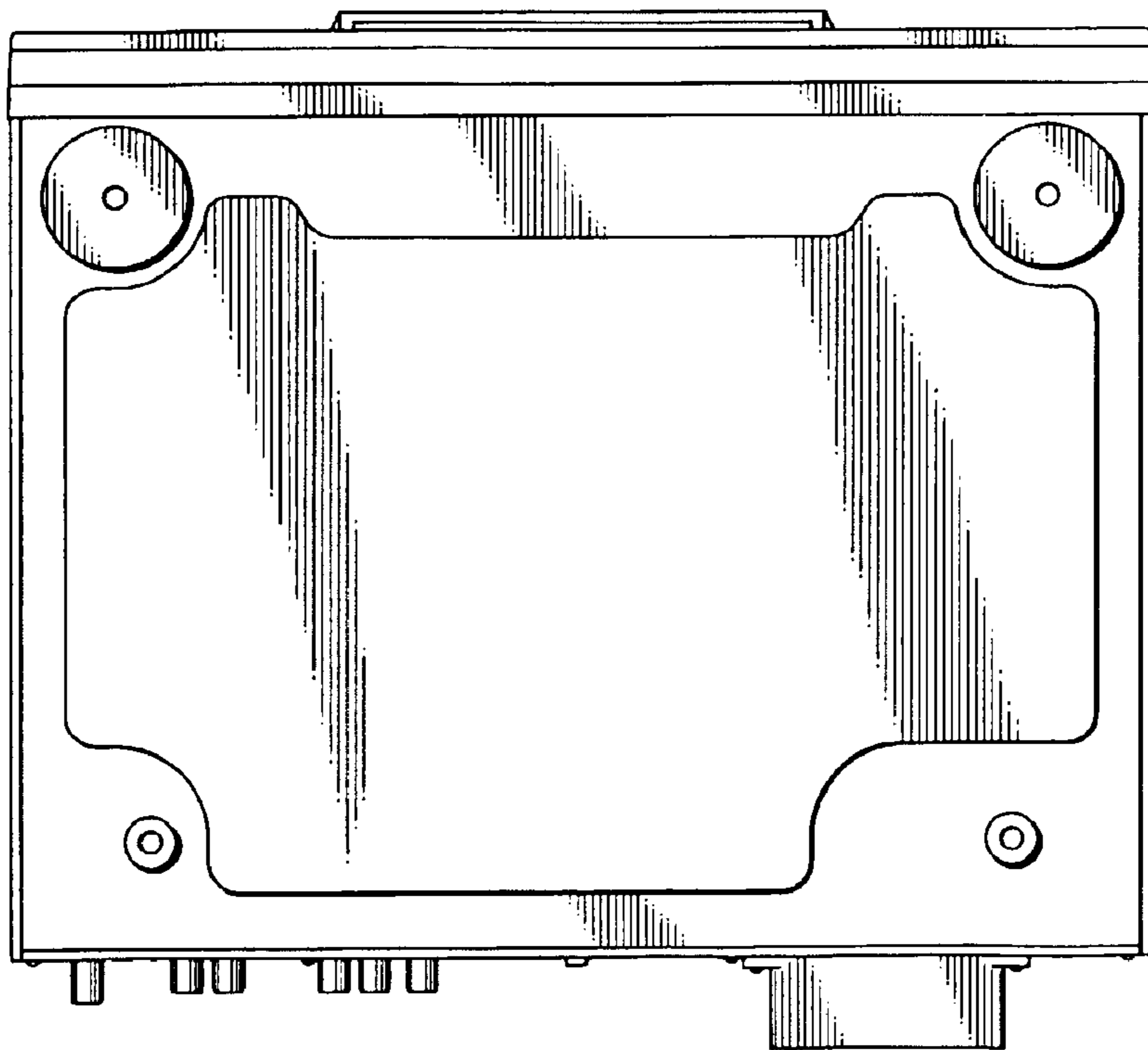

FIG. 6

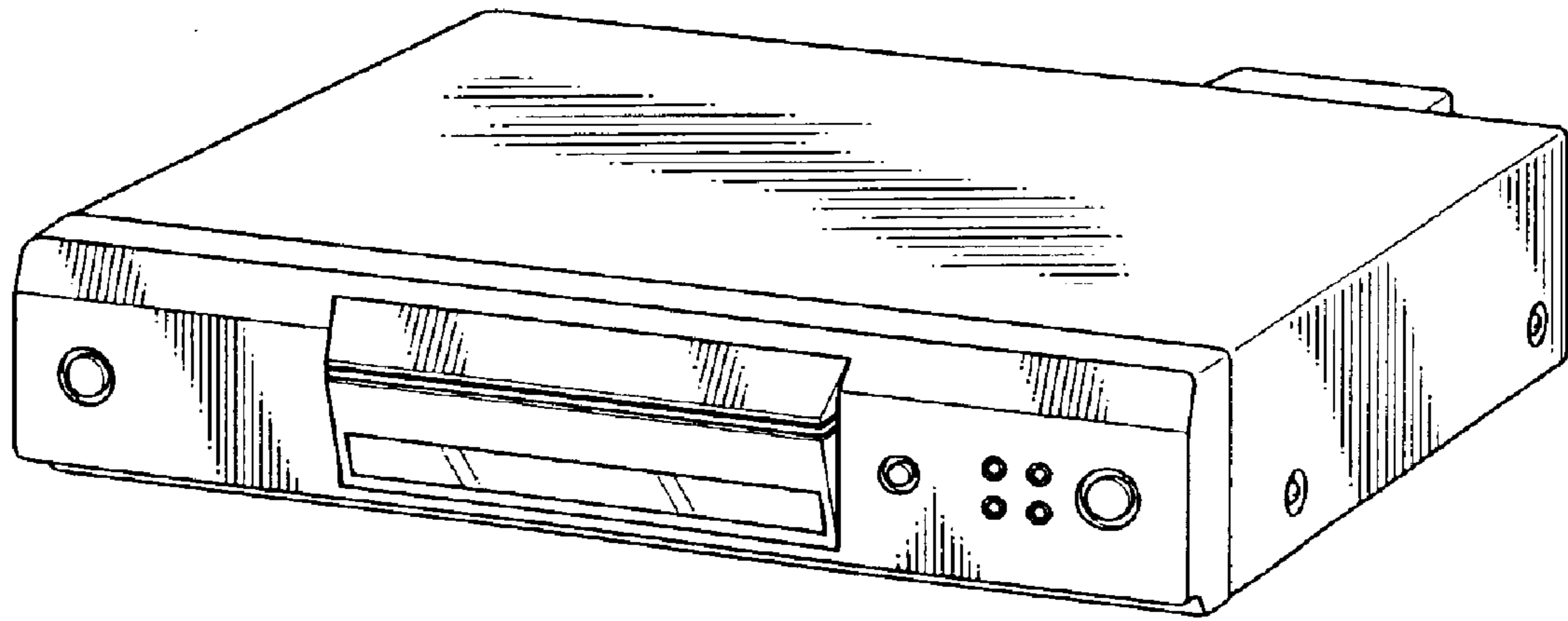

FIG. 7

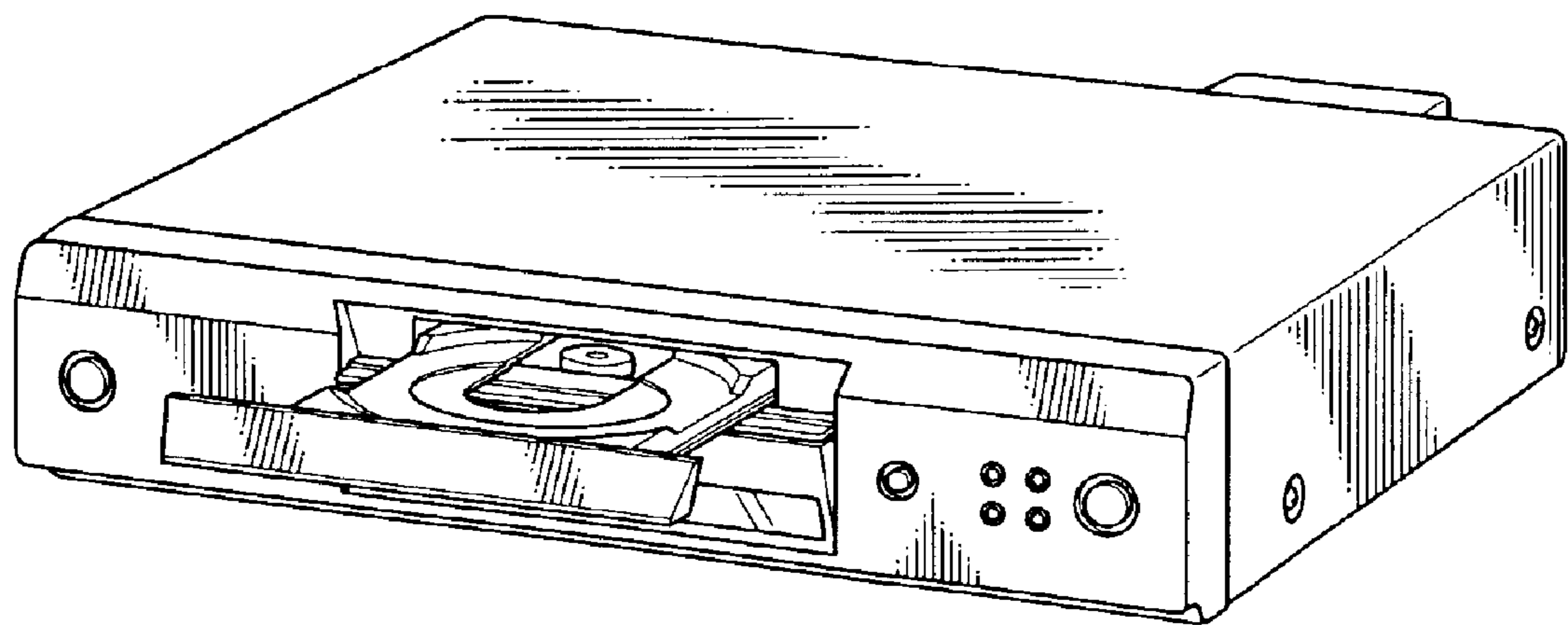

FIG. 8