



US00D510900S

(12) **United States Design Patent**  
**Bucaccio et al.**

(10) **Patent No.:** **US D510,900 S**  
(45) **Date of Patent:** **\*\* Oct. 25, 2005**

(54) **PERSONAL WATERCRAFT**

D464,926 S \* 10/2002 Mizuta et al. .... D12/307  
D479,702 S \* 9/2003 Cassell et al. .... D12/307

(75) Inventors: **Tom Bucaccio**, Sebastian, FL (US);  
**Shannon Cassell**, Palm Bay, FL (US);  
**Kirk Aguero**, Indialantic, FL (US)

\* cited by examiner

*Primary Examiner*—Holly Baynham  
*Assistant Examiner*—Cynthia M. Chin  
(74) *Attorney, Agent, or Firm*—BRP Legal Services

(73) Assignee: **Bombardier Recreational Products Inc.**, Valcourt (CA)

(57) **CLAIM**

(\*\*) Term: **14 Years**

The ornamental design for a personal watercraft, as shown and described.

(21) Appl. No.: **29/211,683**

**DESCRIPTION**

(22) Filed: **Aug. 20, 2004**

(51) **LOC (8) Cl.** ..... **12-06**

(52) **U.S. Cl.** ..... **D12/307**

(58) **Field of Search** ..... D12/300, 307,  
D12/316, 317; 114/55.5, 55.55, 55.57, 270,  
271

FIG. 1 is a front-right perspective view of a personal watercraft according to our design;  
FIG. 2 is a front view thereof;  
FIG. 3 is a rear view thereof;  
FIG. 4 is a top view thereof;  
FIG. 5 is a bottom view thereof;  
FIG. 6 is a left view thereof; and,  
FIG. 7 is a right view thereof.

The portion of the all-terrain vehicle which are not shown in the drawings form no part of the claimed design.

(56) **References Cited**

**U.S. PATENT DOCUMENTS**

D343,160 S \* 1/1994 LaPointe ..... D12/307  
D350,325 S \* 9/1994 Mardikian ..... D12/307

**1 Claim, 6 Drawing Sheets**

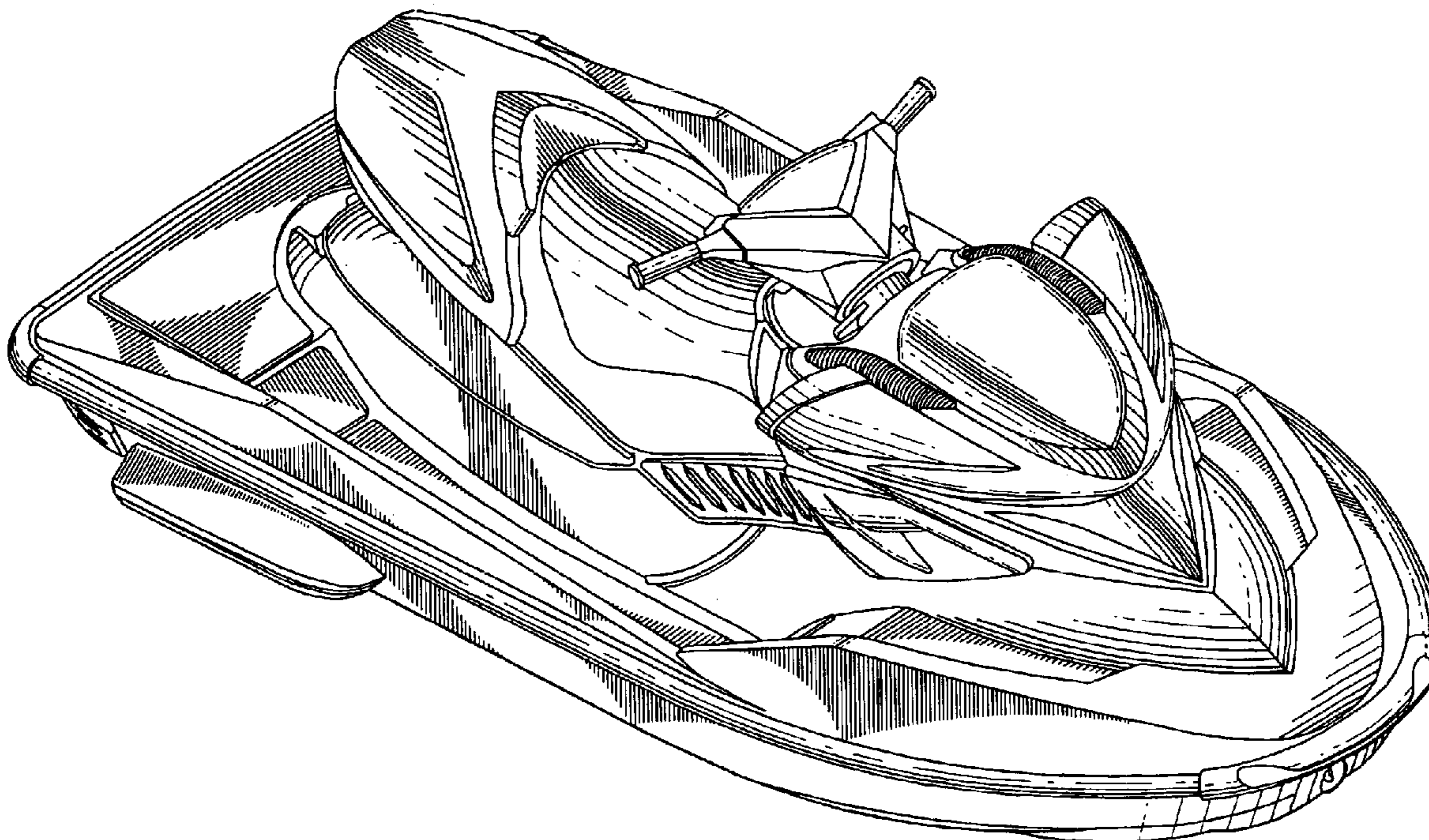

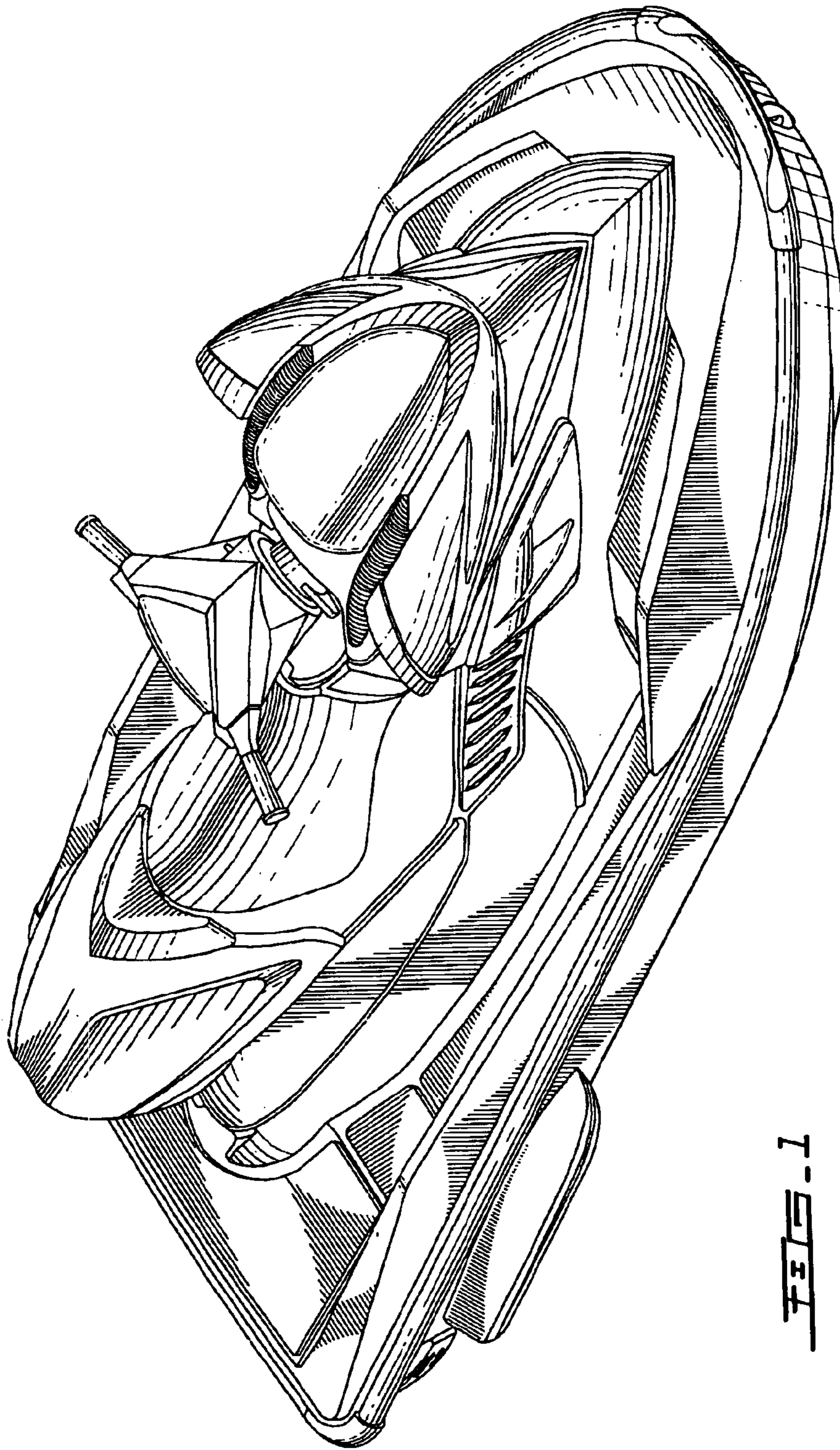

FIG. 1

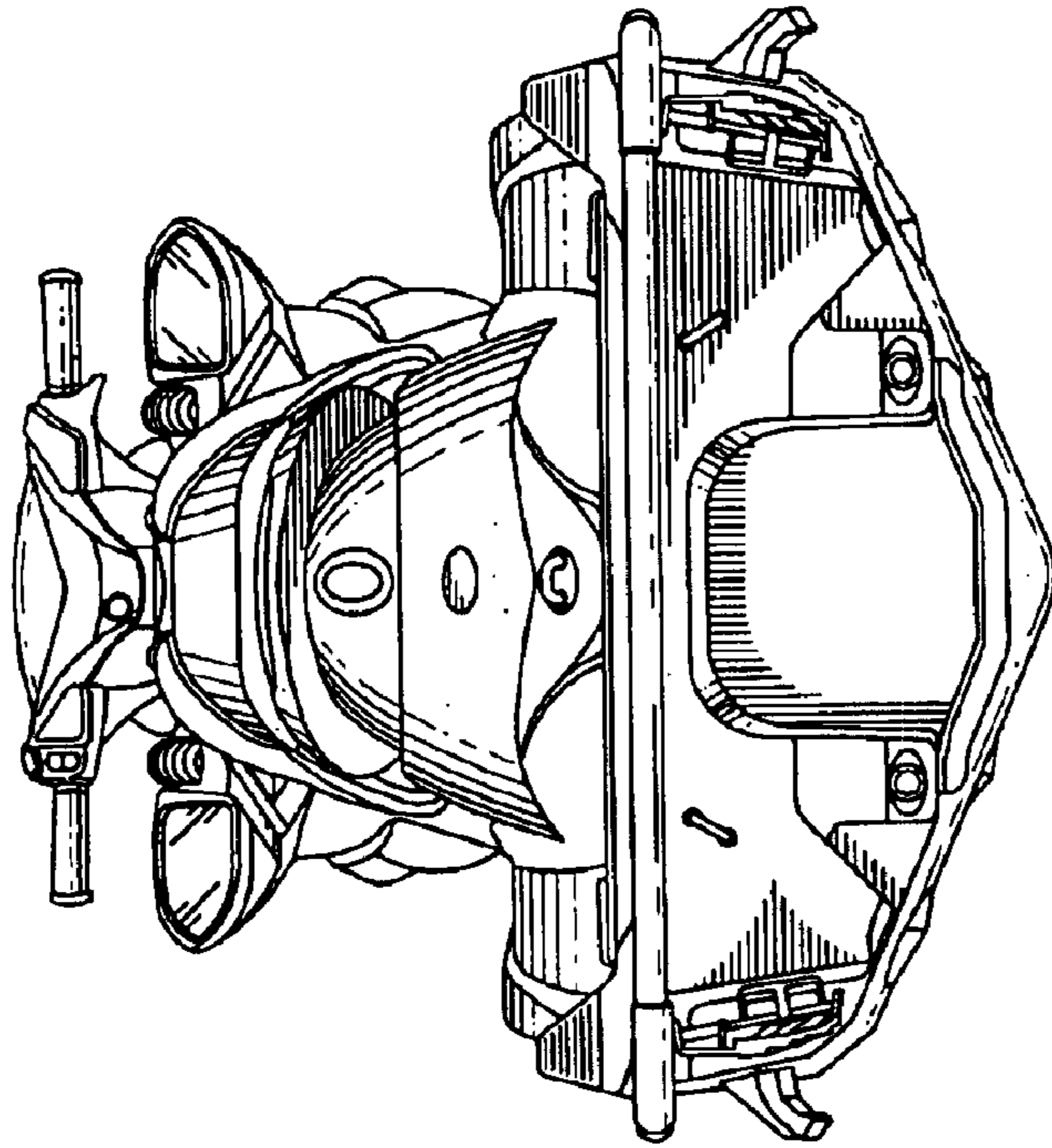

FIG. 3

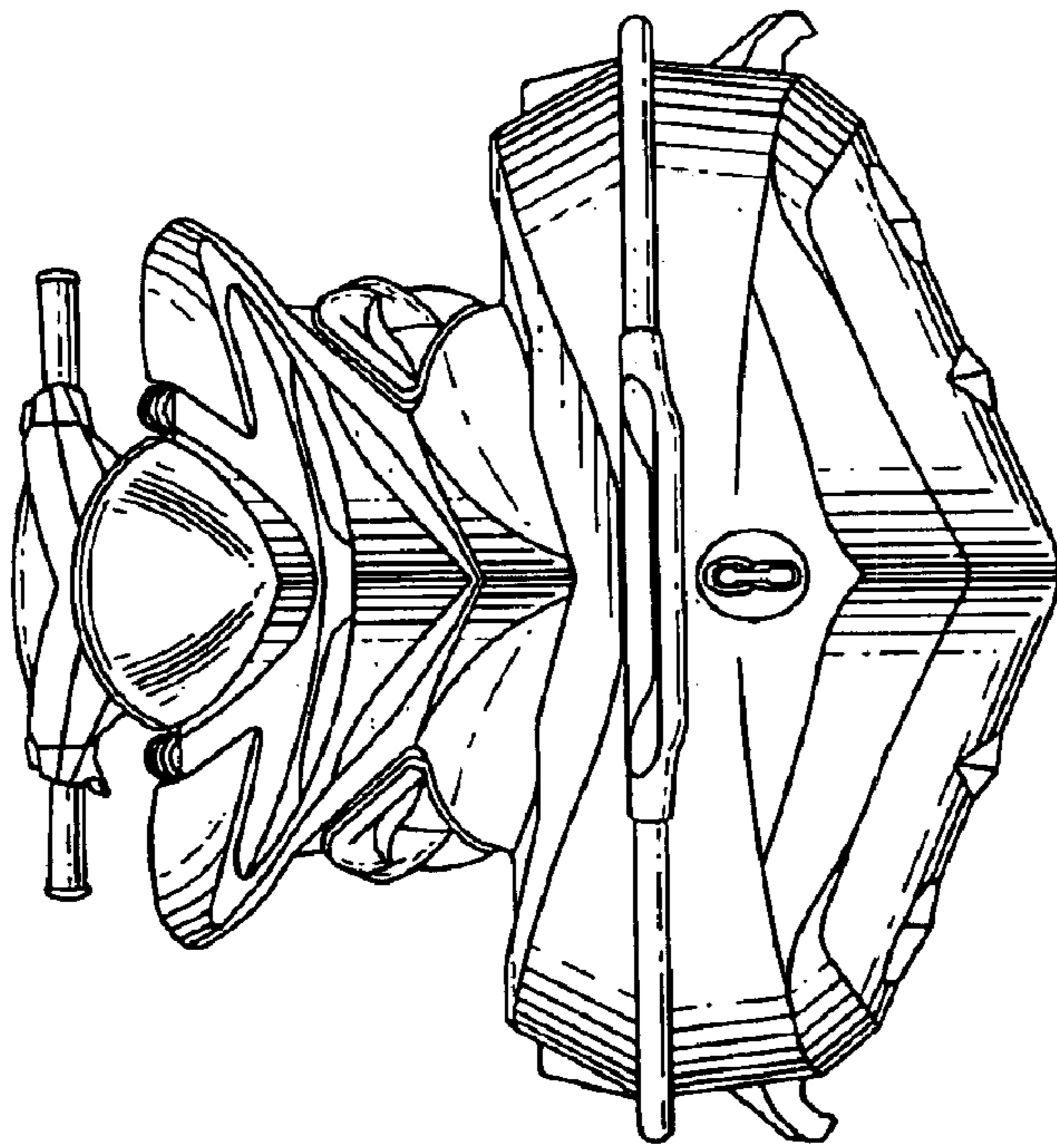

FIG. 2

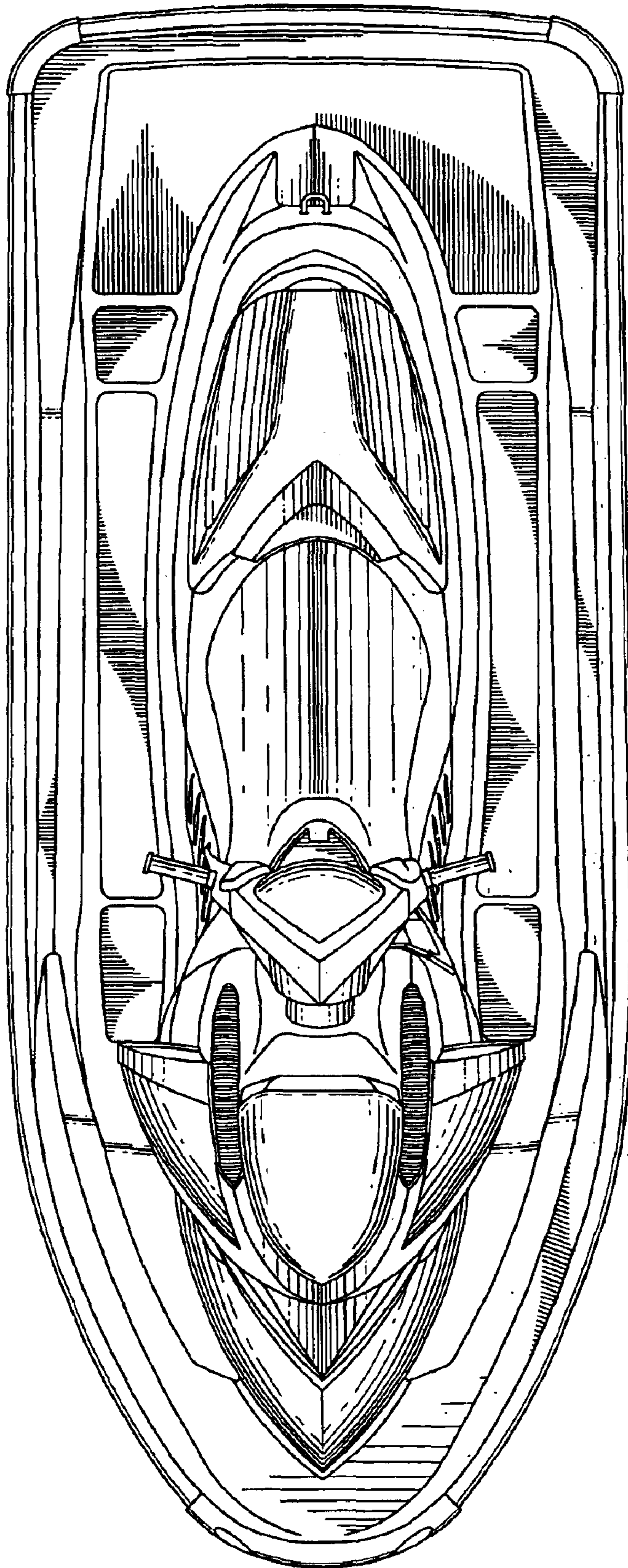

FIG. 4

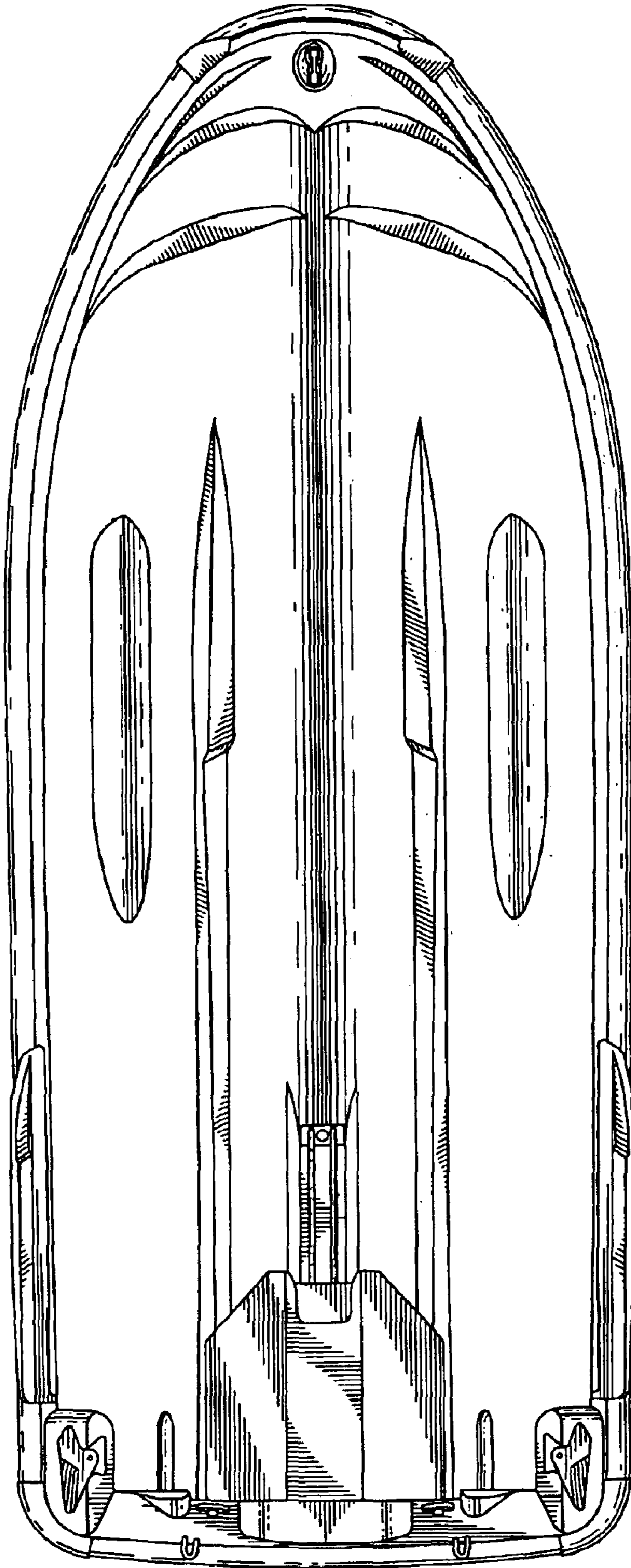

FIG. 5

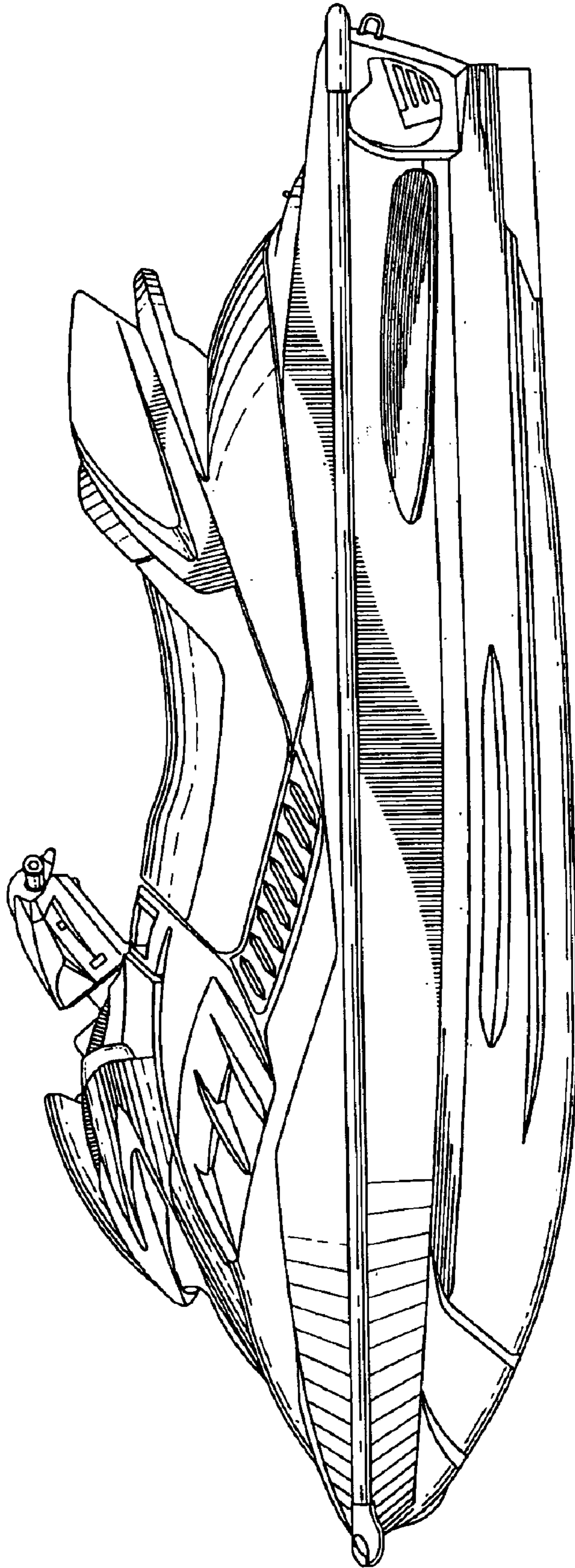

FIG. 6

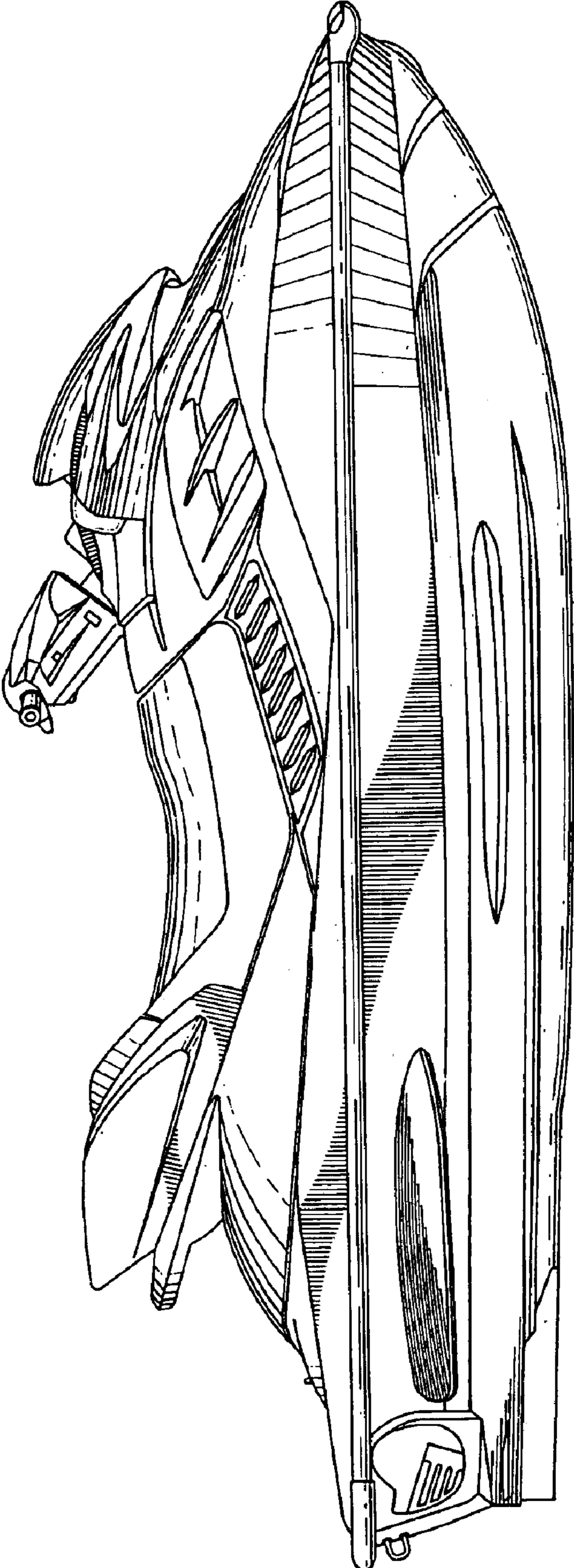

FIG. 7