



US00D510745S

(12) **United States Design Patent**  
**Sakai**

(10) **Patent No.:** **US D510,745 S**  
(45) **Date of Patent:** **\*\* Oct. 18, 2005**

(54) **ELECTRONIC CAMERA**

(75) Inventor: **Masayuki Sakai**, Tokyo (JP)

(73) Assignee: **Fuji Photo Film Co., Ltd.**, Kanagawa (JP)

(\*\*) Term: **14 Years**

(21) Appl. No.: **29/209,718**

(22) Filed: **Jul. 21, 2004**

(30) **Foreign Application Priority Data**

Mar. 26, 2004 (JP) ..... 2004-009176

(51) **LOC (8) Cl.** ..... **16-01**

(52) **U.S. Cl.** ..... **D16/202; D16/200; D16/218**

(58) **Field of Search** ..... **D16/200–206, D16/208, 218, 250; 348/373–376; 358/909.1; 396/6, 429, 535–541**

(56) **References Cited**

**U.S. PATENT DOCUMENTS**

D388,803 S	*	1/1998	Shinano	.....	D16/202
6,141,505 A	*	10/2000	Miyata et al.	.....	396/535
6,163,649 A	*	12/2000	DiRisio	.....	396/538
6,181,883 B1	*	1/2001	Oswal	.....	396/429
D489,385 S	*	5/2004	Lin	.....	D16/202

\* cited by examiner

*Primary Examiner*—Adir Aronovich

(74) *Attorney, Agent, or Firm*—Young & Thompson

(57) **CLAIM**

The ornamental design for an electronic camera, as shown and described.

**DESCRIPTION**

FIG. 1 is a top, front and side perspective view of an electronic camera showing my new design;  
 FIG. 2 is a front elevational view thereof;  
 FIG. 3 is a rear elevational view thereof;  
 FIG. 4 is a top plan view thereof;  
 FIG. 5 is a bottom plan view thereof;  
 FIG. 6 is a side elevational view thereof from the left of FIG. 2;  
 FIG. 7 is a side elevational view thereof from the right of FIG. 2;  
 FIG. 8 is a top, rear and side perspective view thereof;  
 FIG. 9 is a view similar to FIG. 8 but with the parts in a different position;  
 FIG. 10 is a front elevational view thereof in the FIG. 9 position;  
 FIG. 11 is a rear elevational view thereof in the FIG. 9 position;  
 FIG. 12 is a top plan view thereof in the FIG. 9 position;  
 FIG. 13 is a bottom plan view thereof in the FIG. 9 position;  
 and,  
 FIG. 14 is a side elevational view thereof from the right of FIG. 10, in the FIG. 9 position.

**1 Claim, 10 Drawing Sheets**

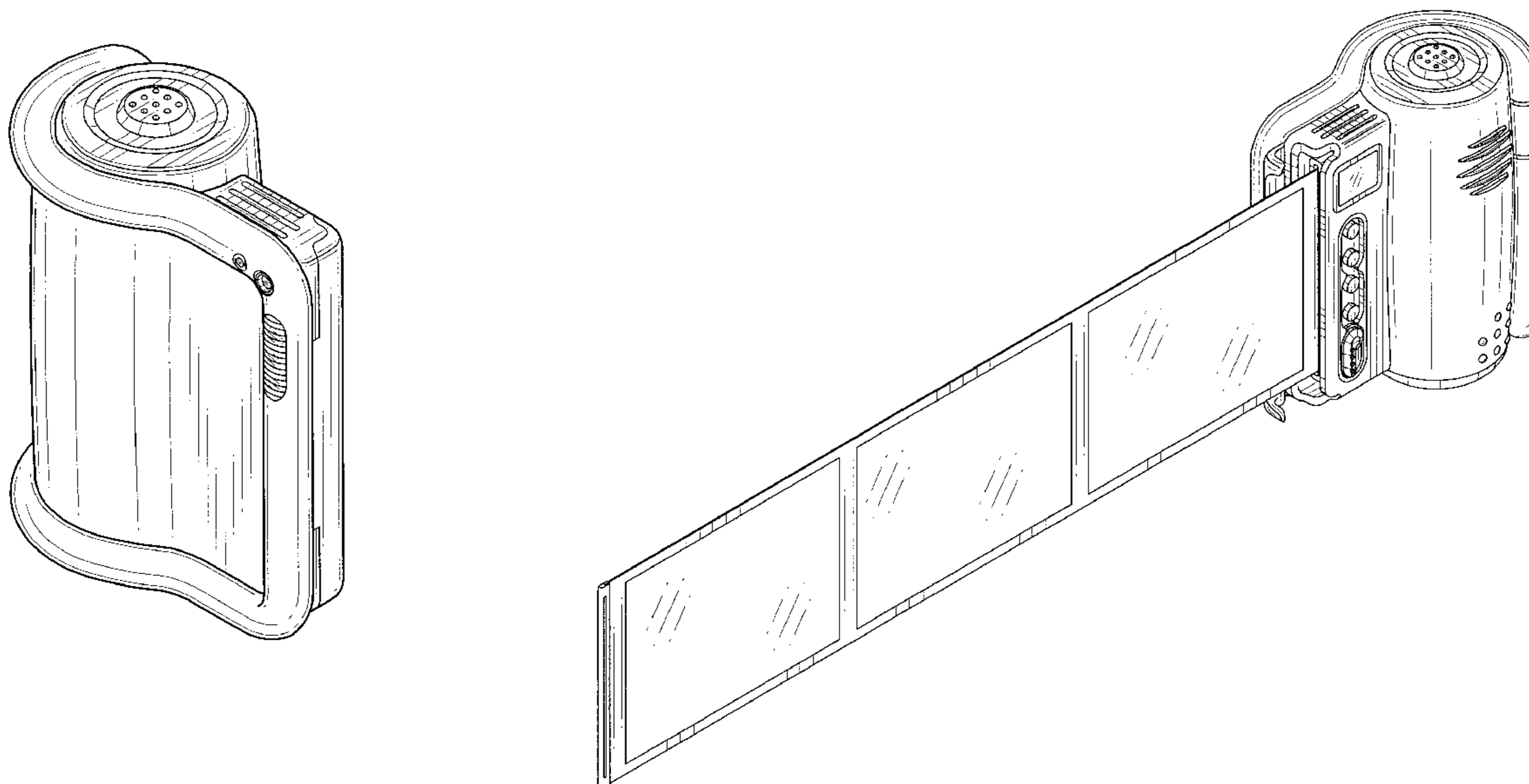

FIG. 1

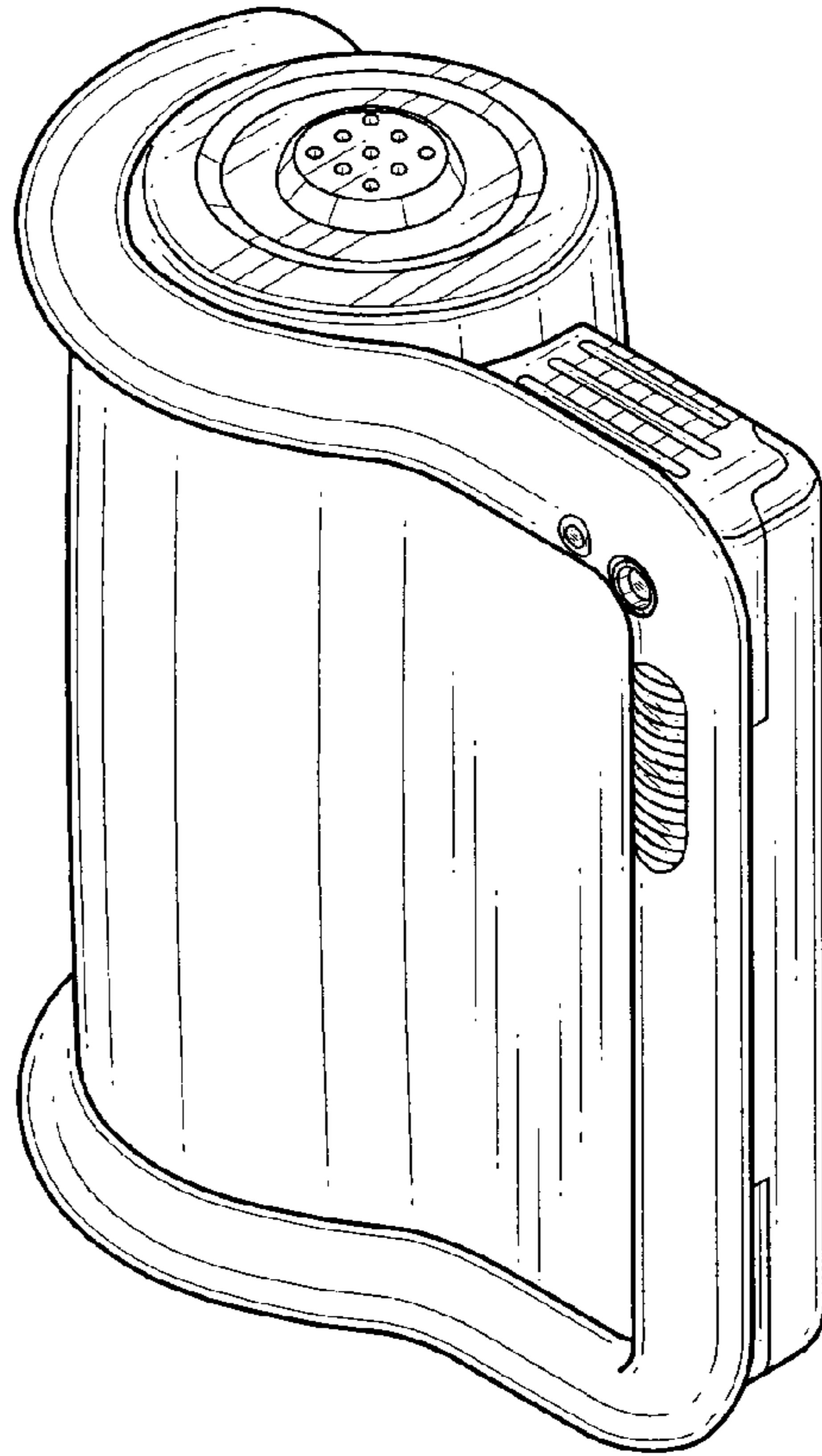

FIG. 2

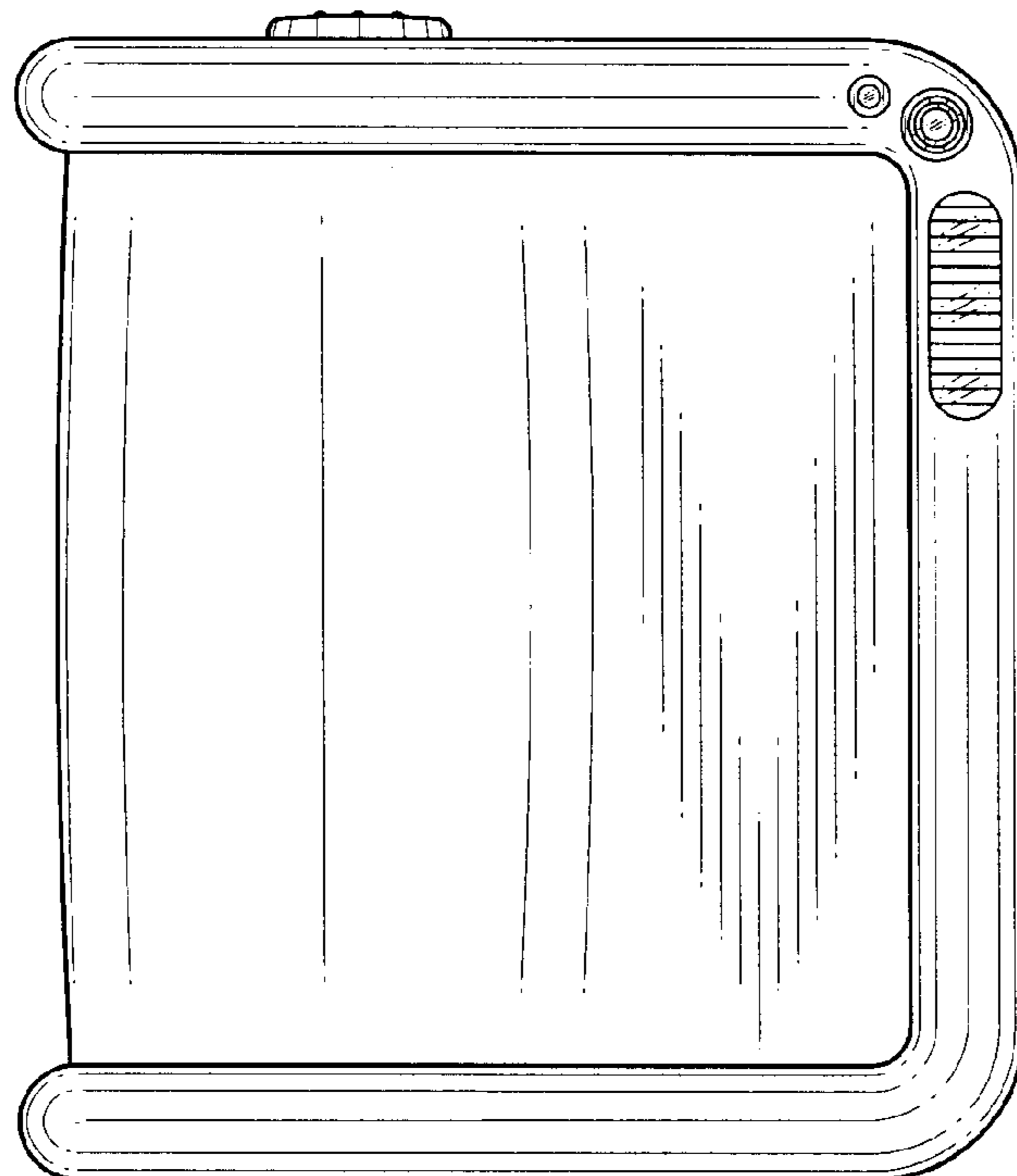

FIG.3

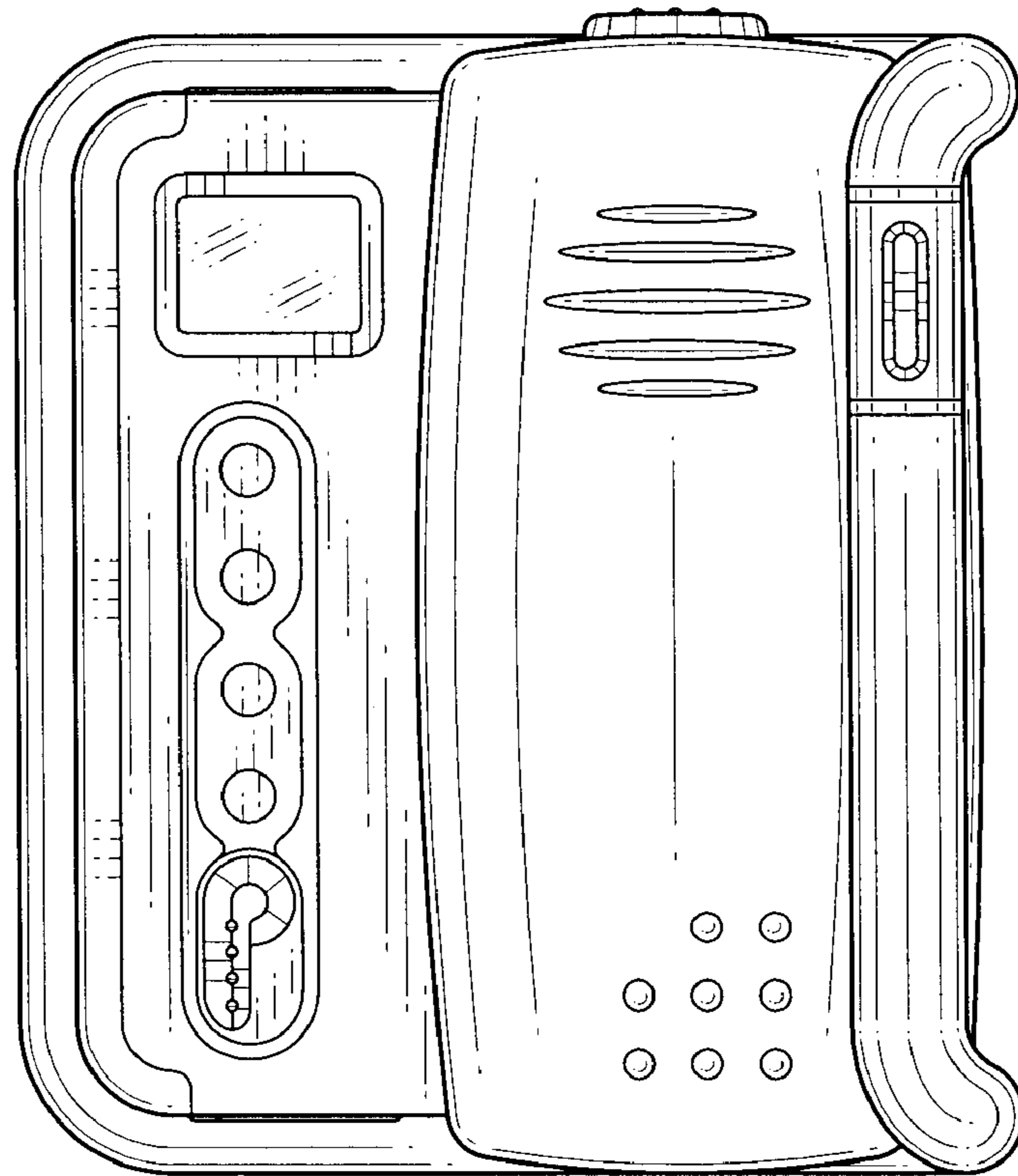

FIG.4

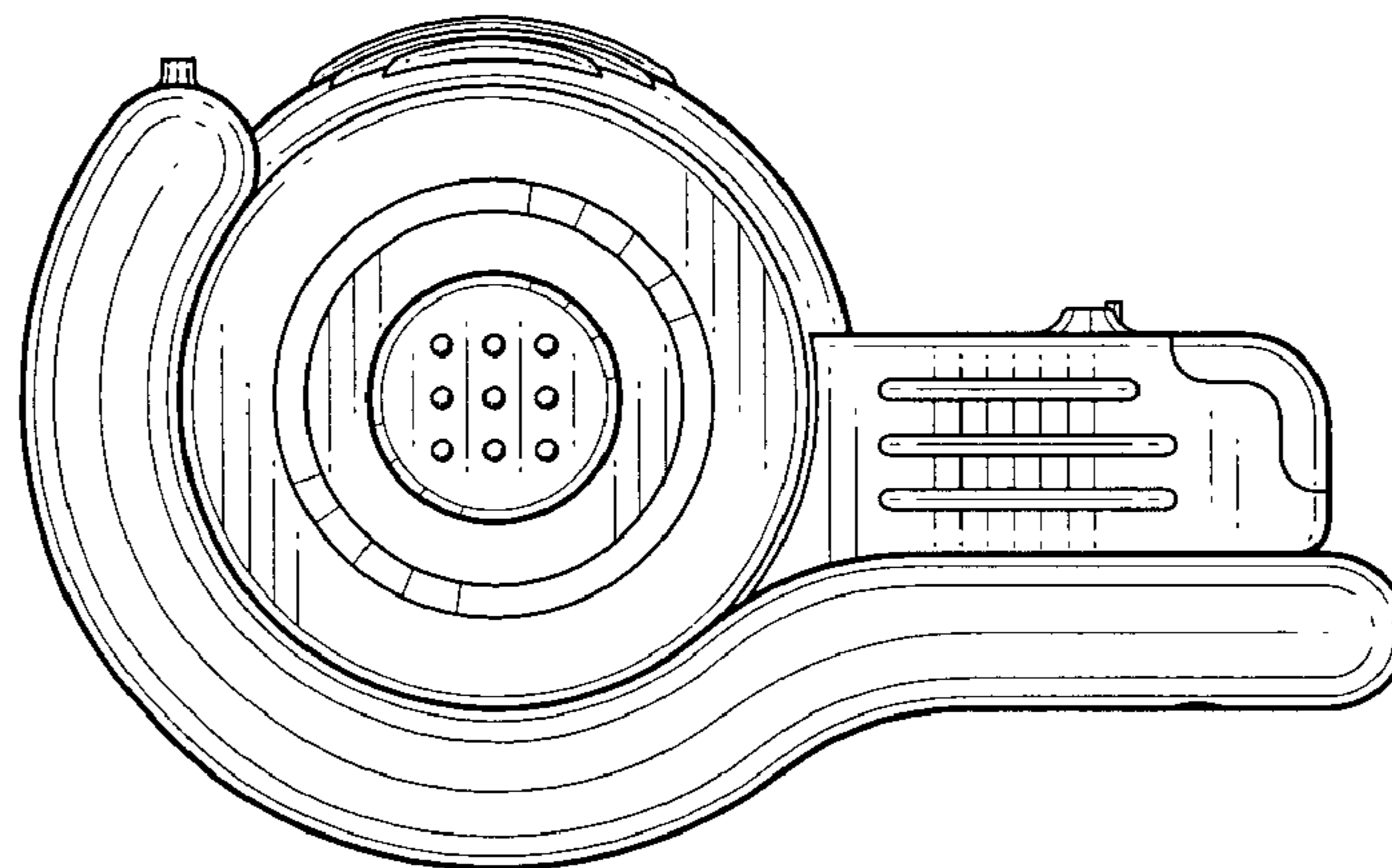

FIG.5

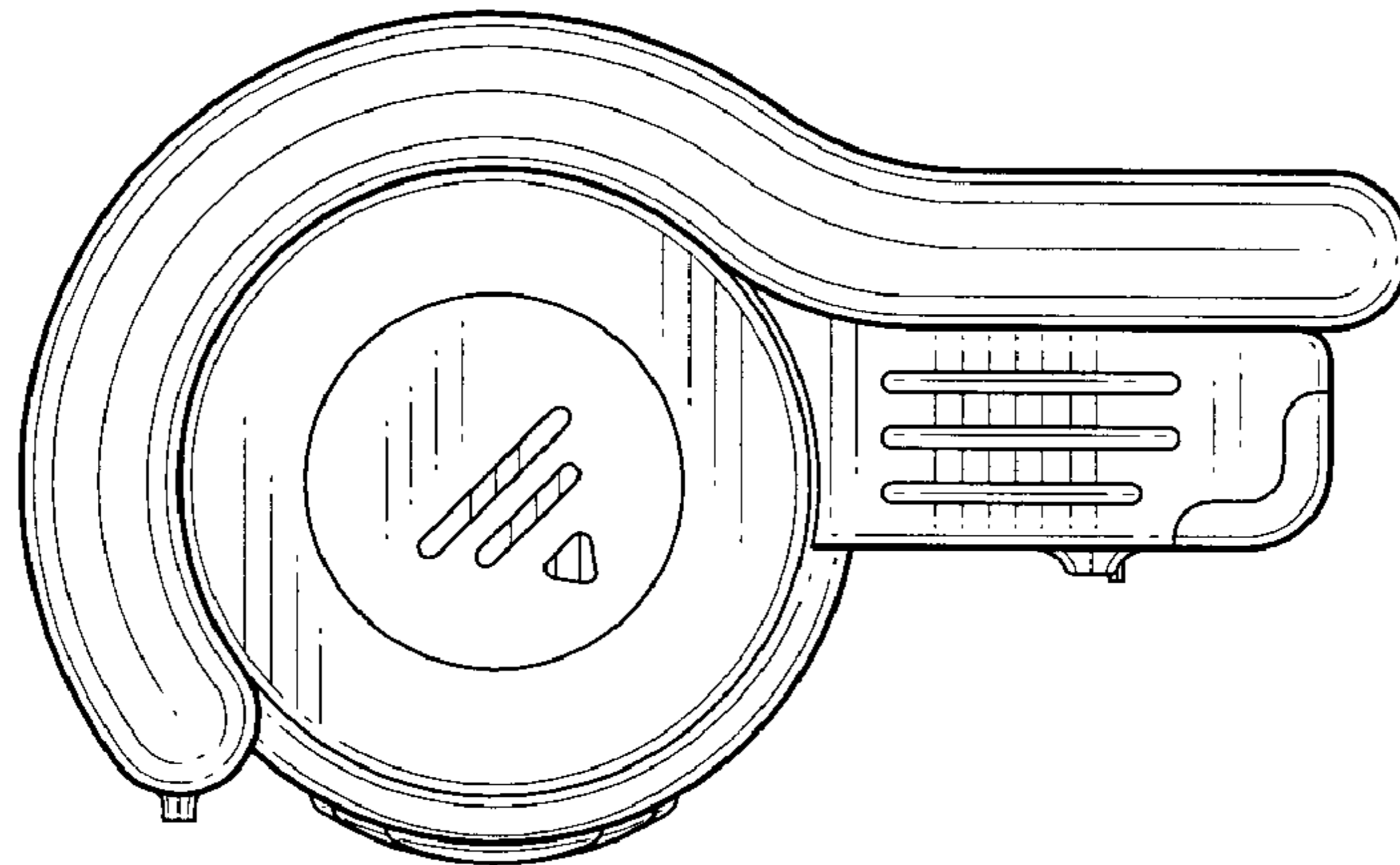

FIG.6

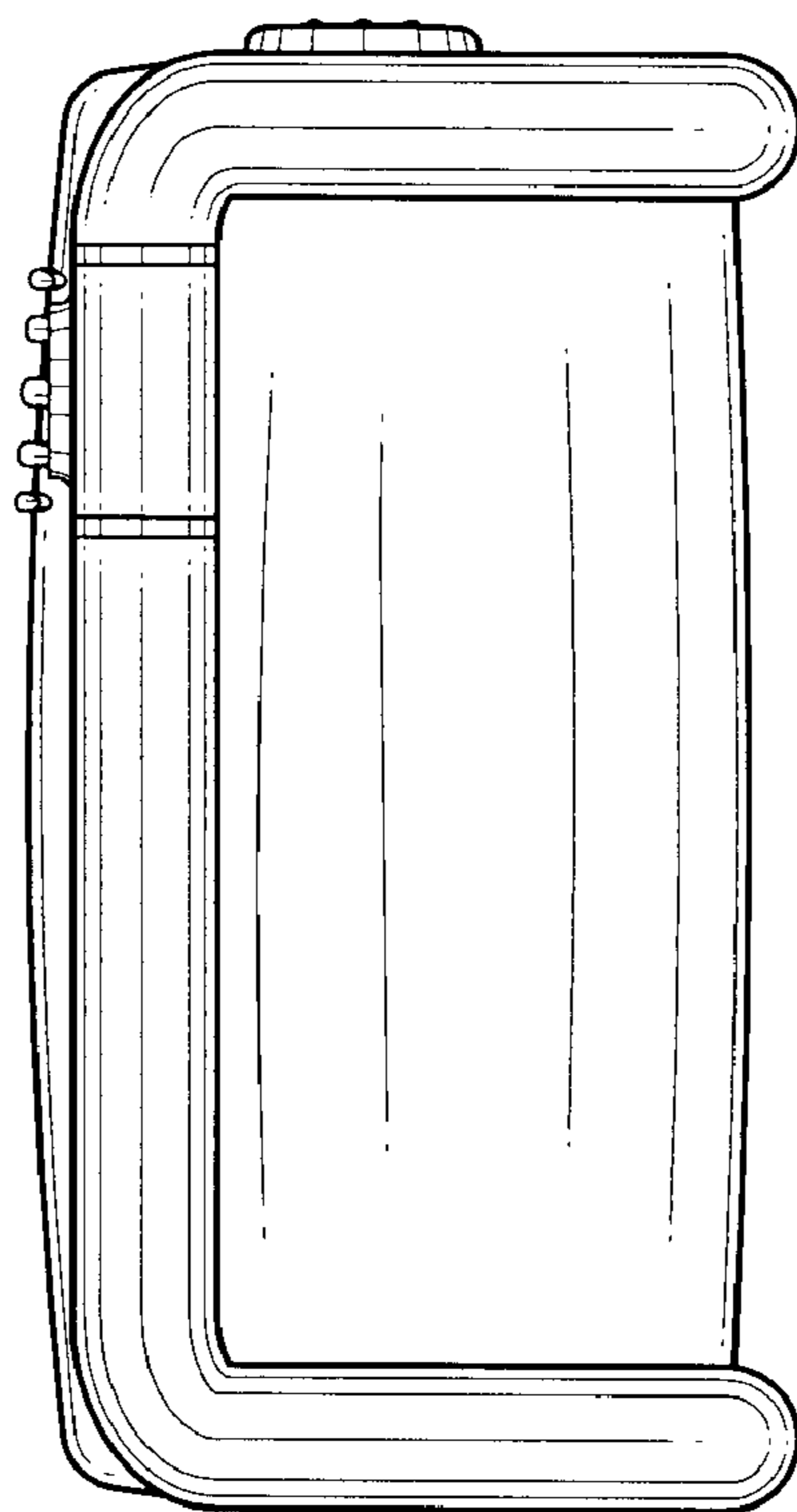

FIG.7

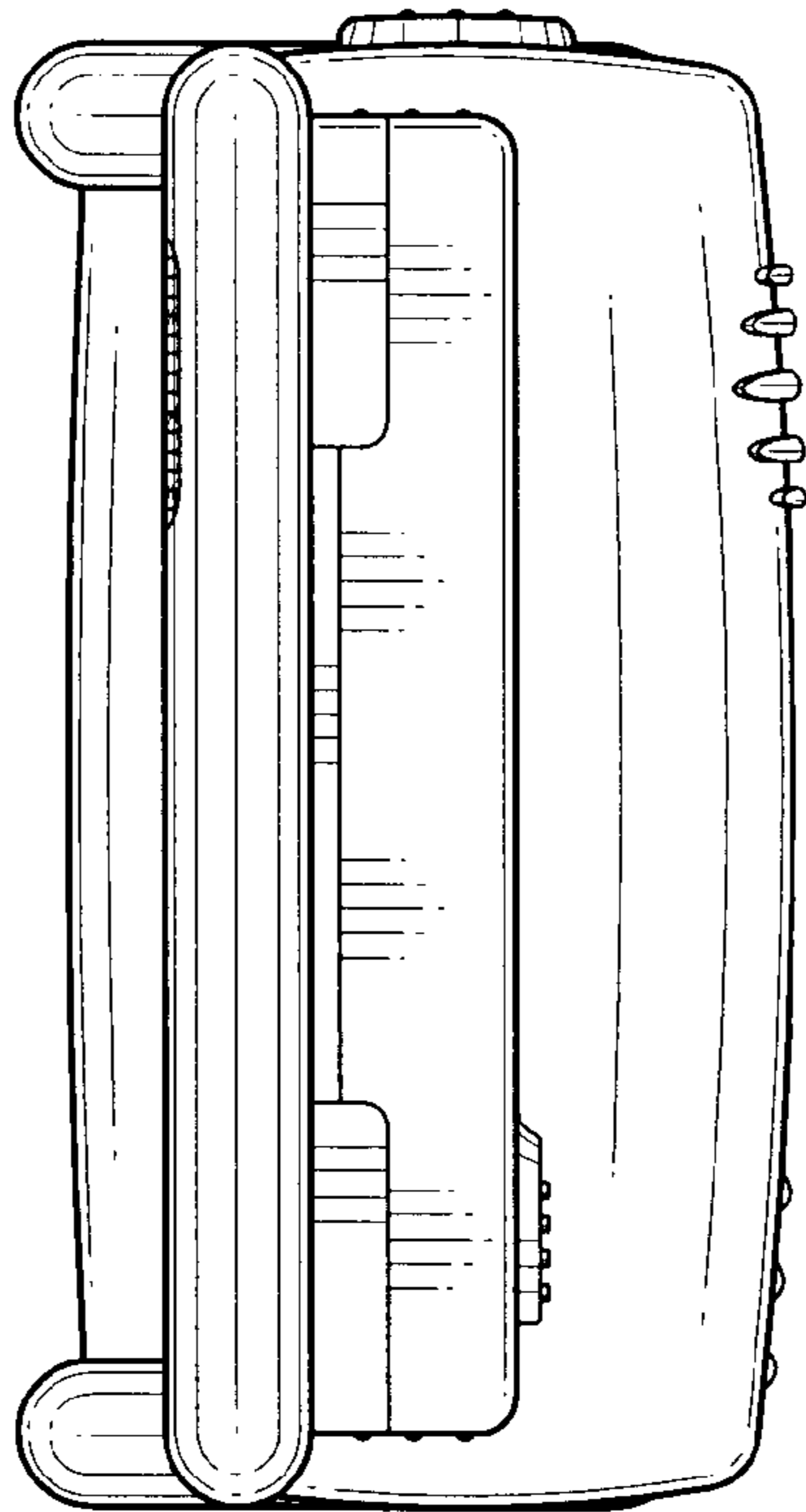
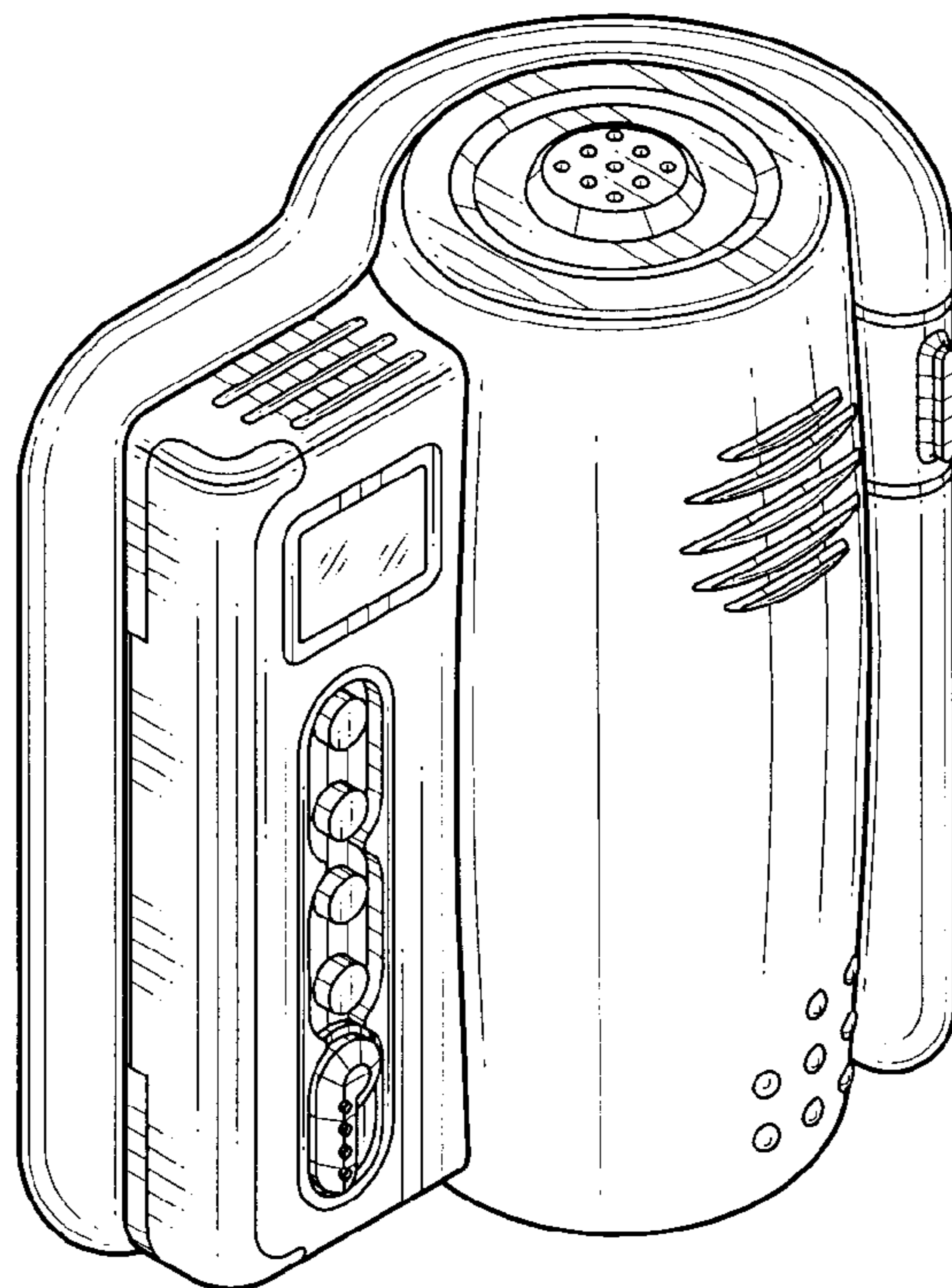

FIG.8





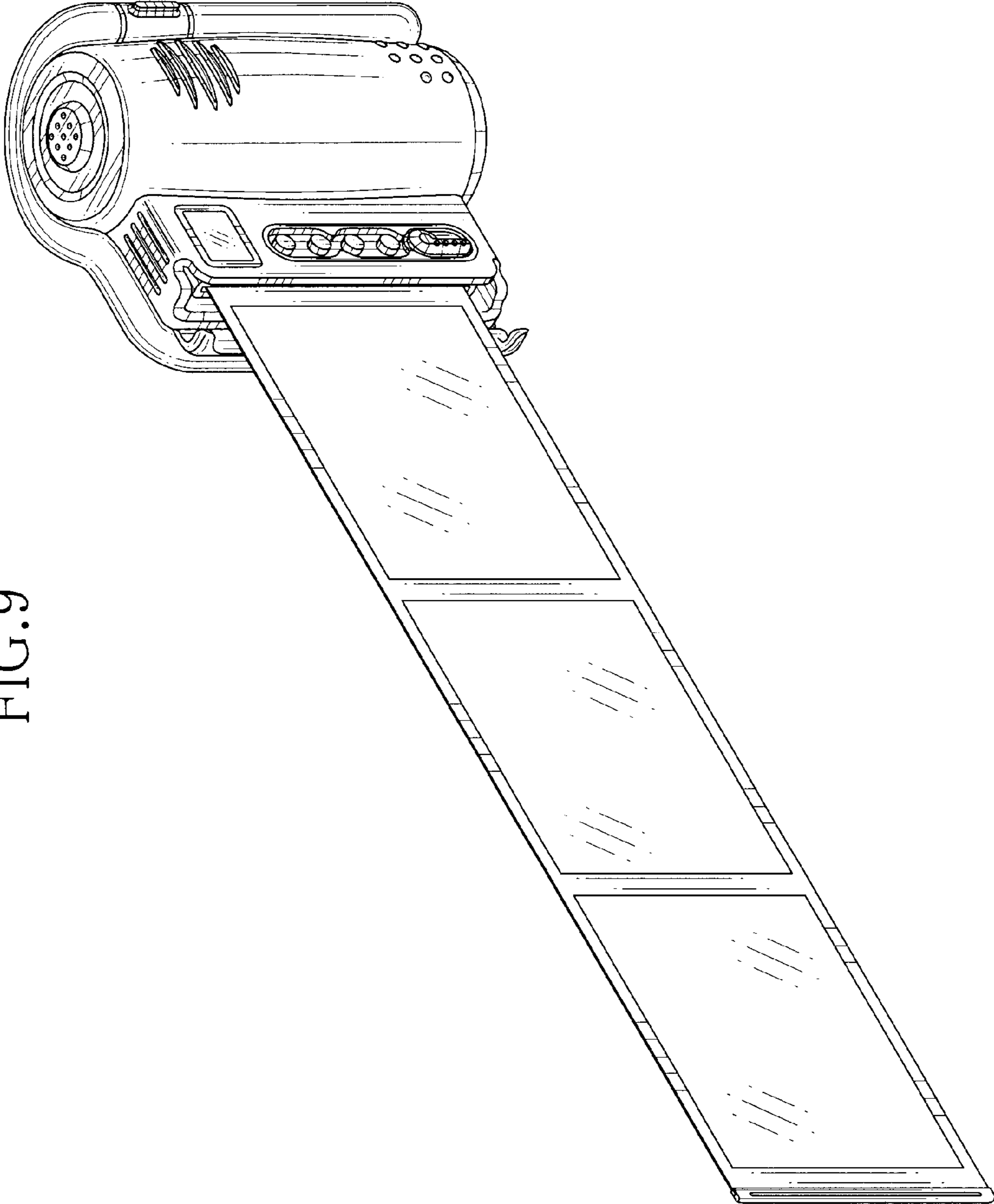
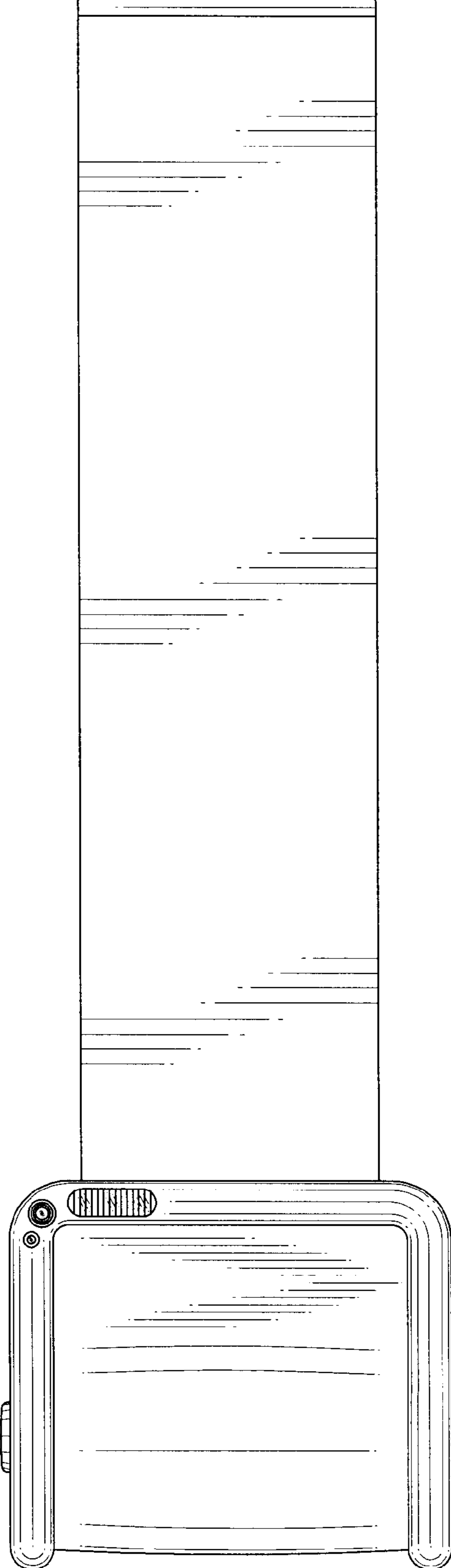

FIG.9

FIG. 10



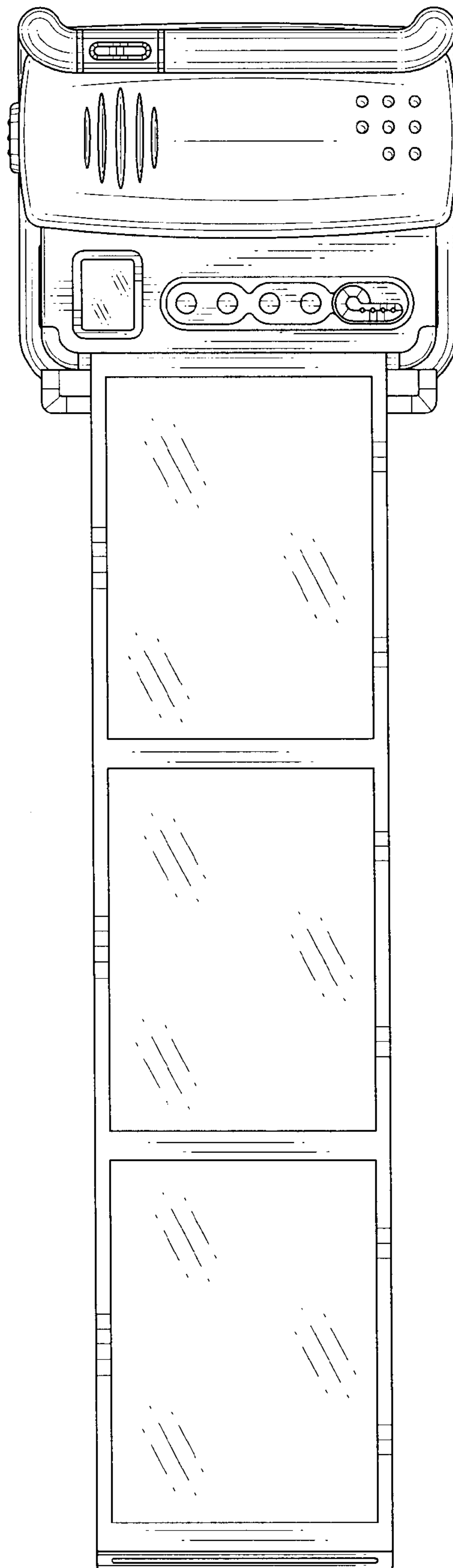

FIG.11



FIG.12

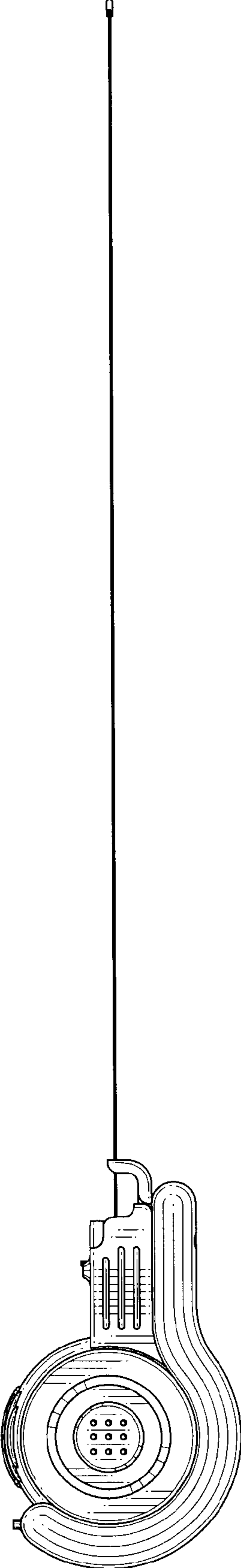

FIG.13

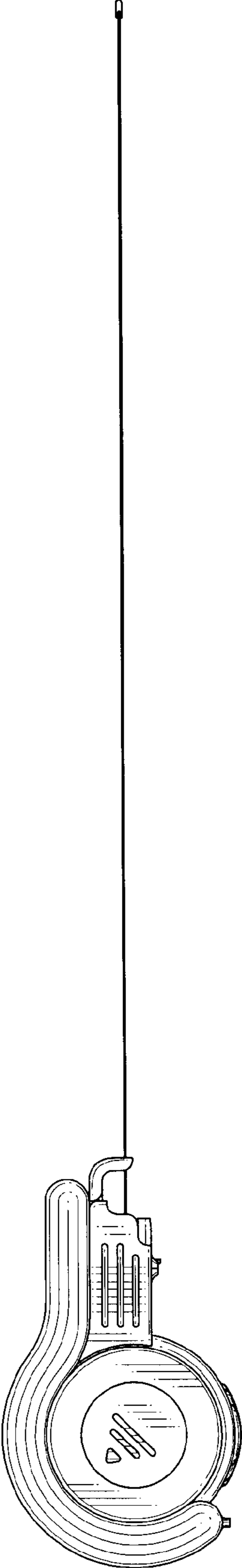

FIG. 14

