



US00D510656S

(12) **United States Design Patent**  
**Brewer**

(10) **Patent No.: US D510,656 S**  
(45) **Date of Patent: \*\* Oct. 18, 2005**

(54) **UMBRELLA HAVING A QUICK RELEASE CLAMP**

(76) Inventor: **Vincent Brewer**, 121 Gail Ct., East Northport, NY (US) 11731-3824

(\*\*) Term: **14 Years**

(21) Appl. No.: **29/221,397**

(22) Filed: **Jan. 13, 2005**

**Related U.S. Application Data**

(62) Division of application No. 29/187,535, filed on Aug. 1, 2003.

(51) **LOC (8) Cl. .... 03-03**

(52) **U.S. Cl. .... D3/5**

(58) **Field of Search** ..... D3/5-6, 10, 12-13; 135/98, 16, 37, 19.5, 21-24, 25.1, 25.2, 33.7, 20.1; 297/184.16; D8/72; 248/511

(56) **References Cited**

**U.S. PATENT DOCUMENTS**

2,988,310 A	*	6/1961	Wright	.....	248/511
5,478,041 A	*	12/1995	Mayne	.....	248/514
5,582,384 A	*	12/1996	Schoen	.....	248/536
5,584,458 A	*	12/1996	Rando	.....	248/231.41
D383,967 S	*	9/1997	DeMars	.....	D8/354
D396,185 S	*	7/1998	Fraser	.....	D8/396
5,833,359 A	*	11/1998	Hollenbach	.....	362/250
5,836,327 A	*	11/1998	Davis	.....	135/16
D413,429 S	*	9/1999	Carson	.....	D3/10

6,082,694 A	*	7/2000	Joyce	.....	248/288.31
6,244,759 B1	*	6/2001	Russo	.....	396/428
6,401,736 B1	*	6/2002	Jerry	.....	135/25.1
6,412,767 B1	*	7/2002	Beckmann et al.	.....	269/166
6,438,854 B1	*	8/2002	Kott, Jr.	.....	33/286
D488,043 S	*	4/2004	Ben-Gigi	.....	D8/72
D490,289 S	*	5/2004	Chuang	.....	D8/72

\* cited by examiner

*Primary Examiner*—Robert A. Delehanty

(74) *Attorney, Agent, or Firm*—Dilworth & Barrese LLP

(57) **CLAIM**

The ornament design for the umbrella having a quick release clamp, as shown and described.

**DESCRIPTION**

FIG. 1 is a front plan view of my new design, with the umbrella open;  
 FIG. 2 is a front plan view of my new design, with the umbrella closed;  
 FIG. 3 is a top view of the umbrella having a quick release clamp of FIG. 1;  
 FIG. 4 is a top view of the umbrella having a quick release clamp of FIG. 2;  
 FIG. 5 is a bottom view of the umbrella having a quick release clamp of FIG. 1;  
 FIG. 6 is a bottom view of the umbrella having a quick release clamp of FIG. 2; and,  
 FIG. 7 is a perspective view of the umbrella having a quick release clamp of my new design, with the umbrella open.

**1 Claim, 5 Drawing Sheets**

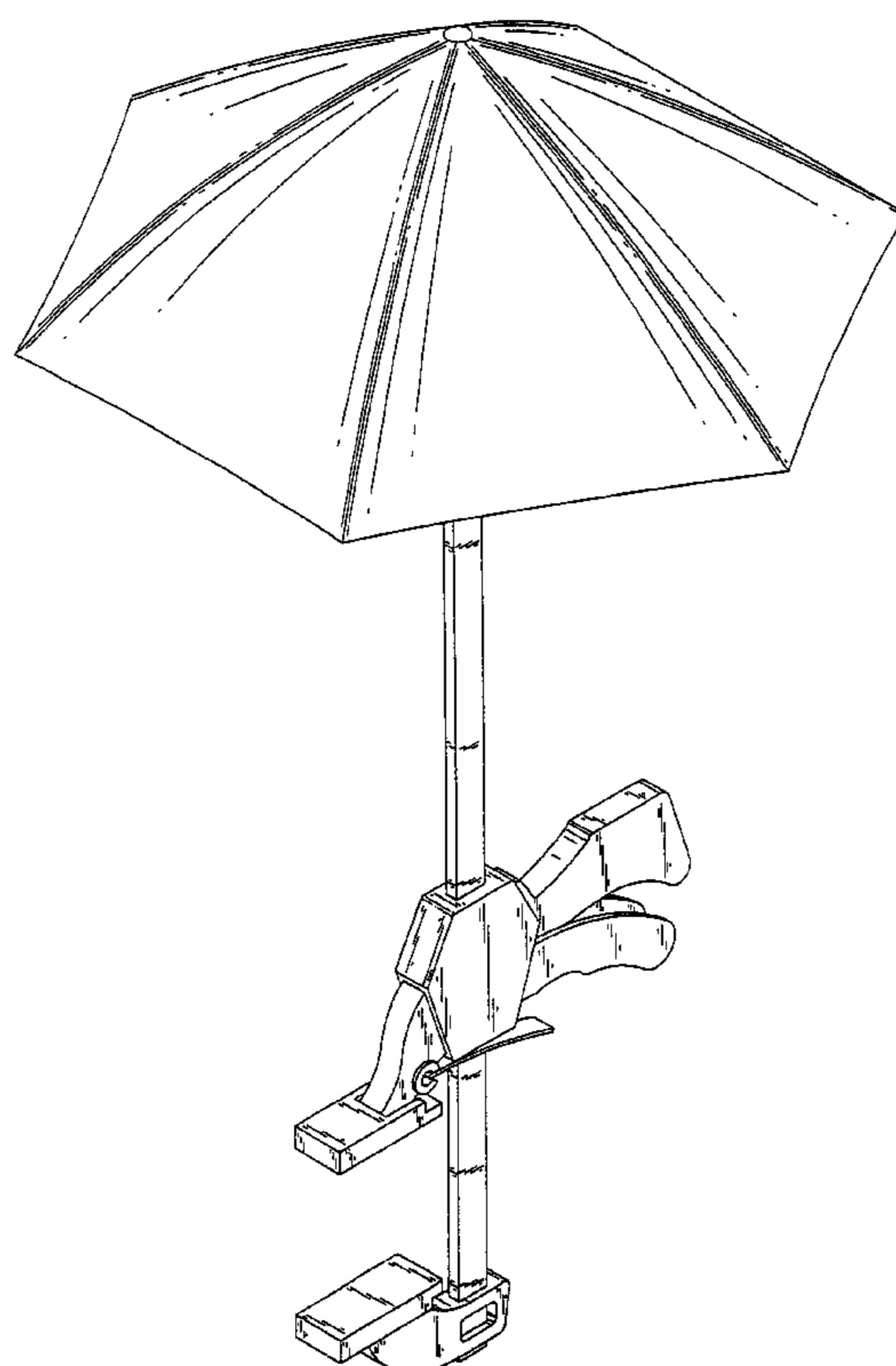

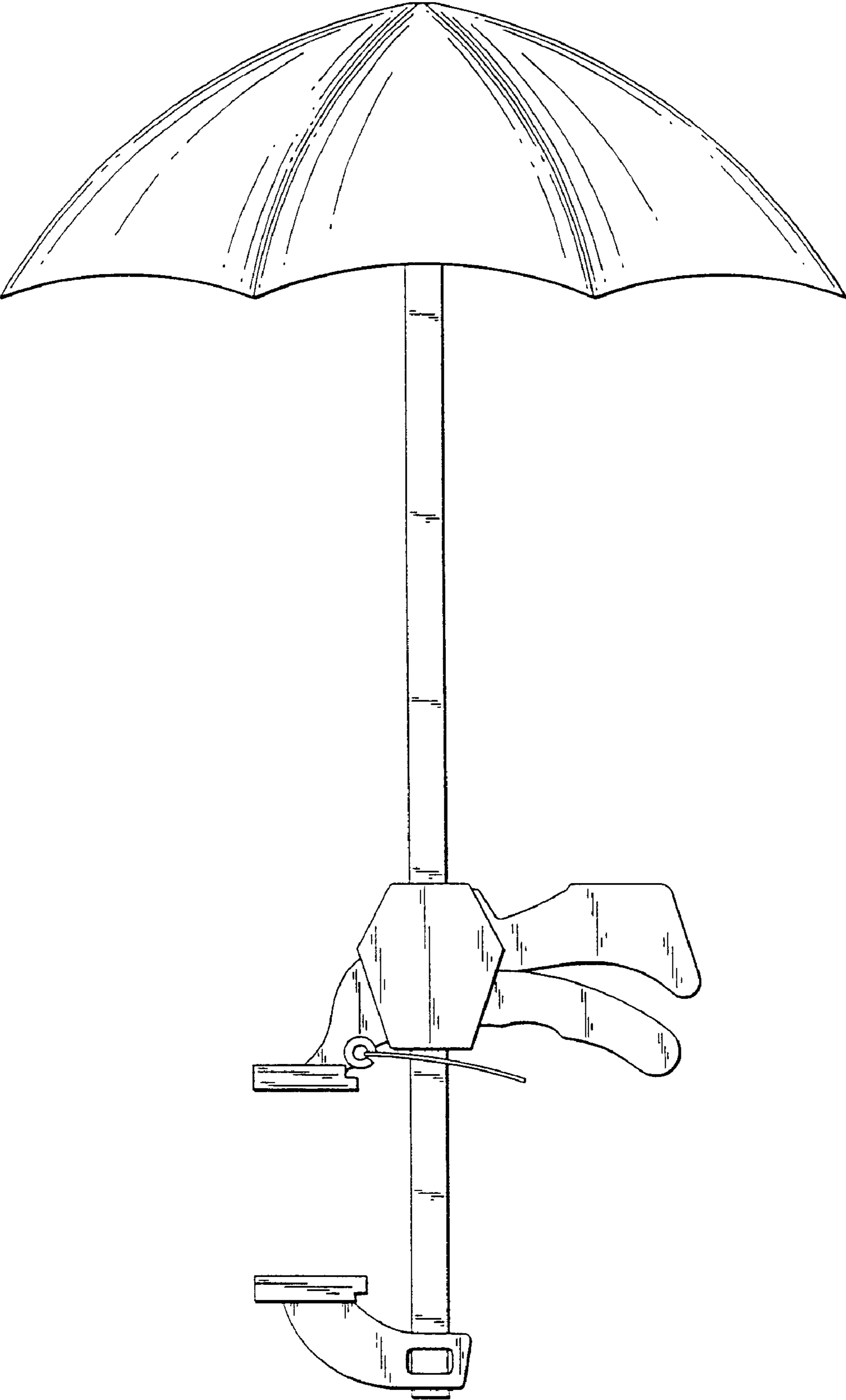

FIG. 1

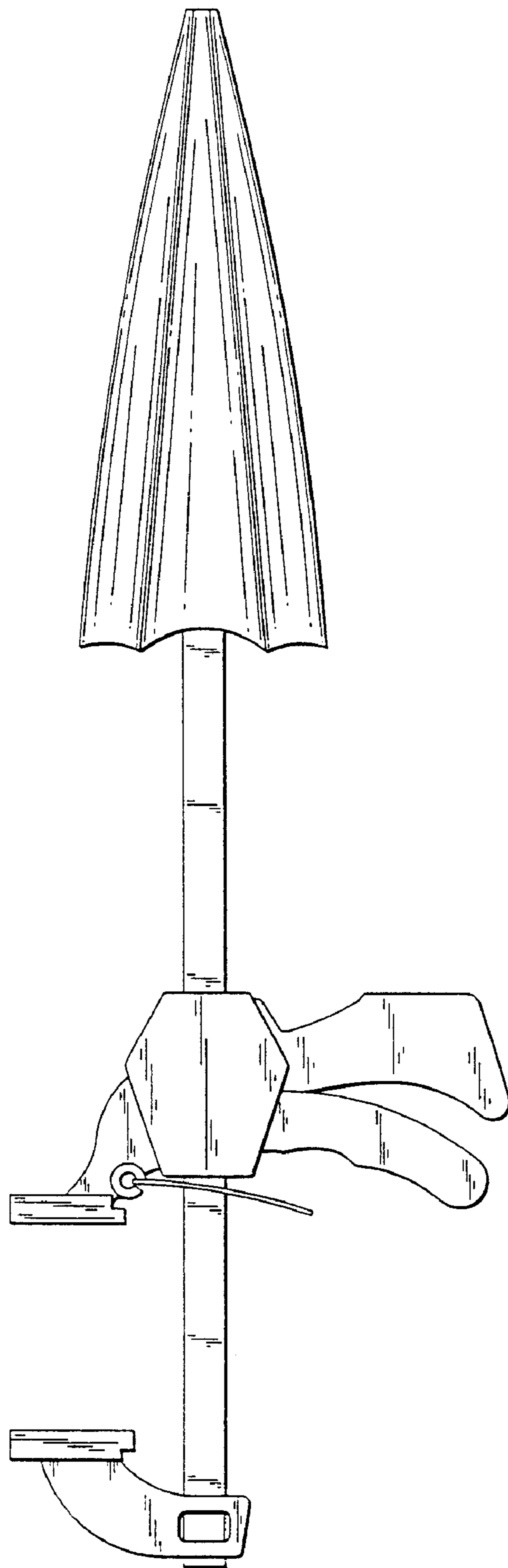

FIG. 2

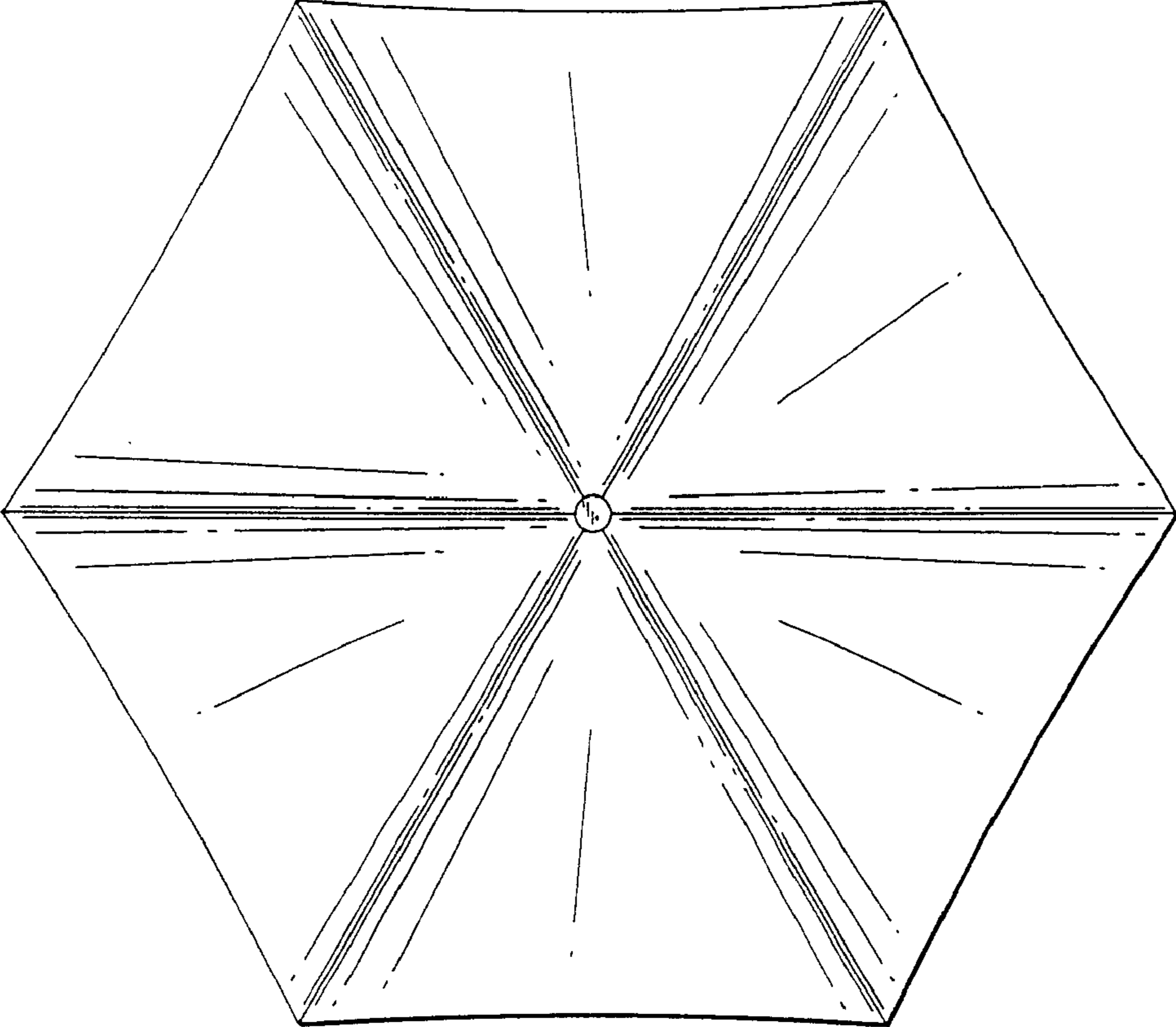

FIG. 3

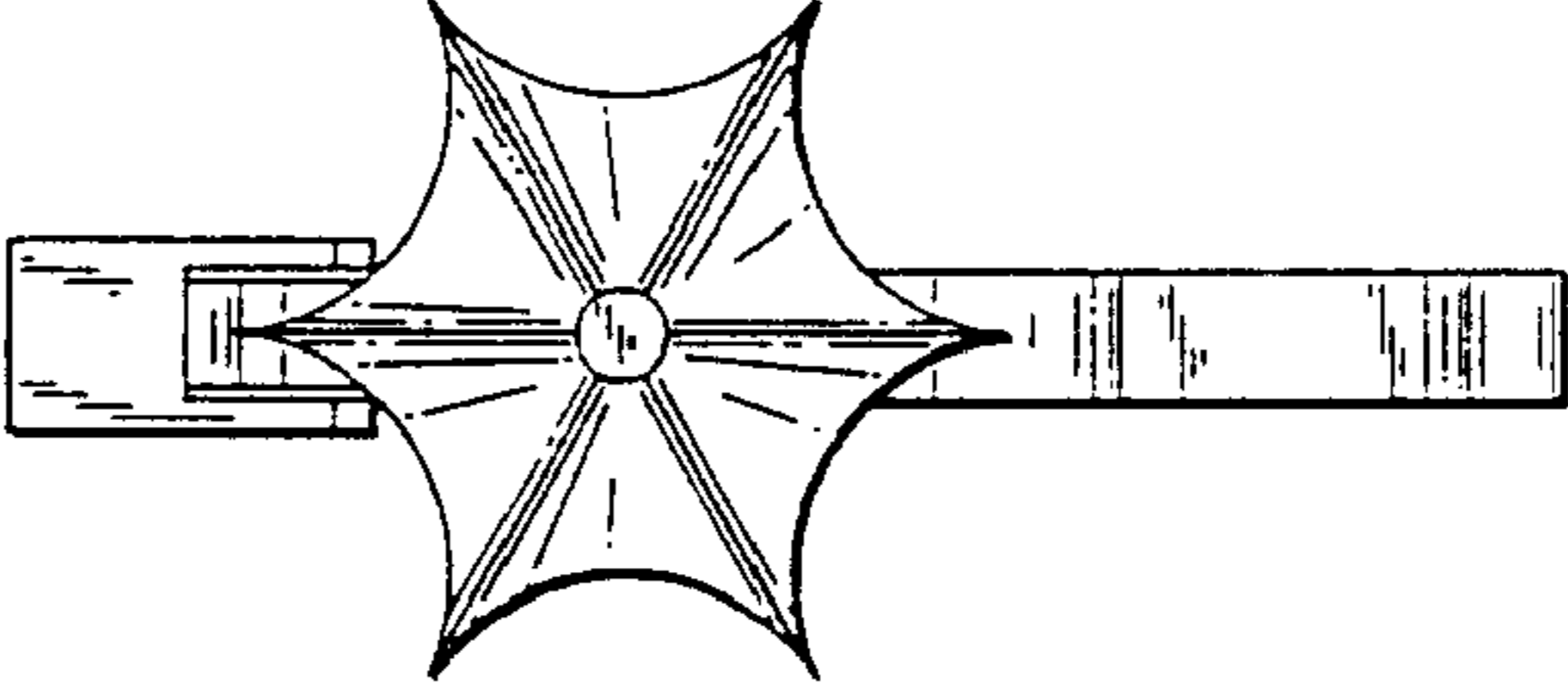

FIG. 4

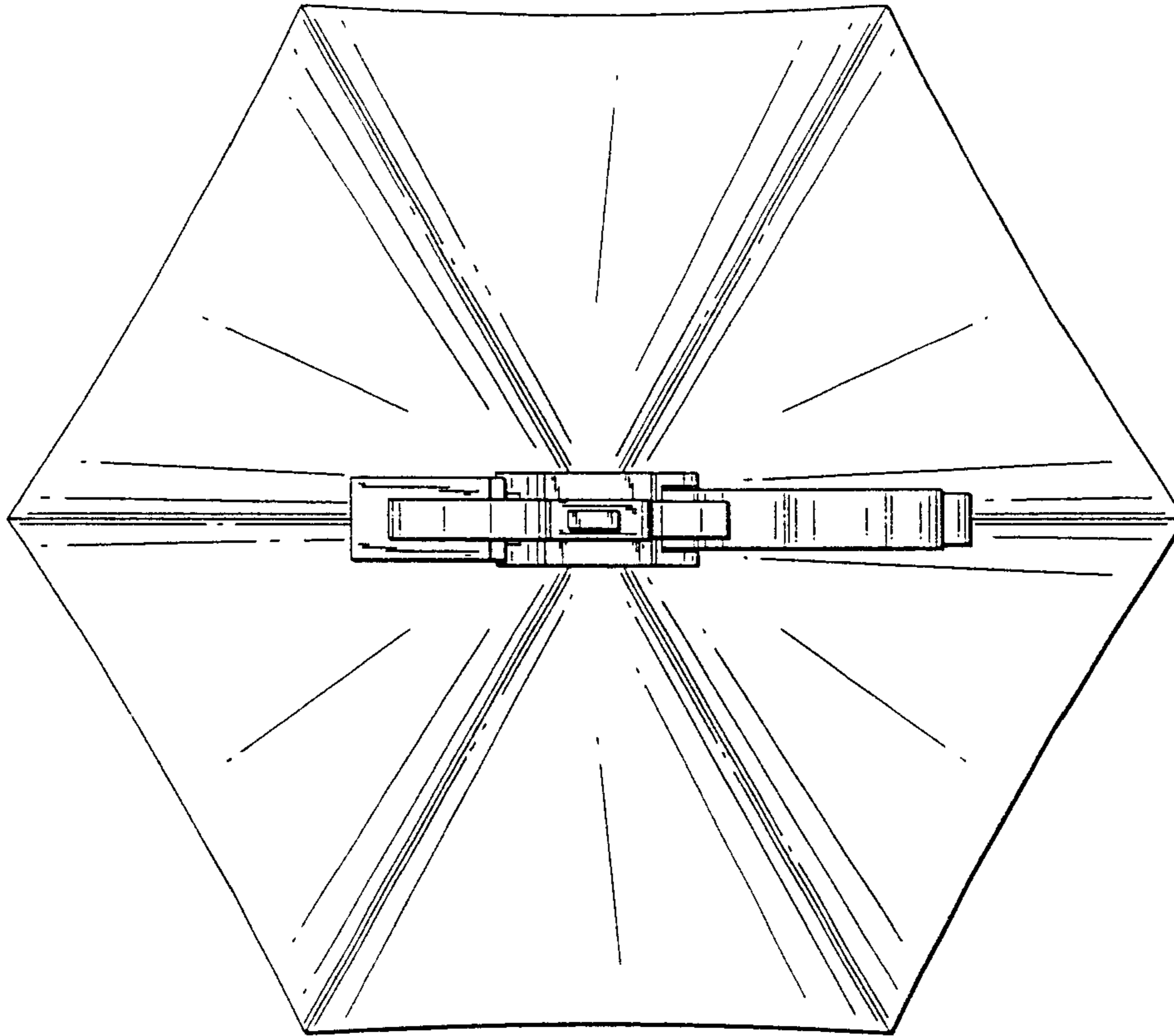

FIG. 5

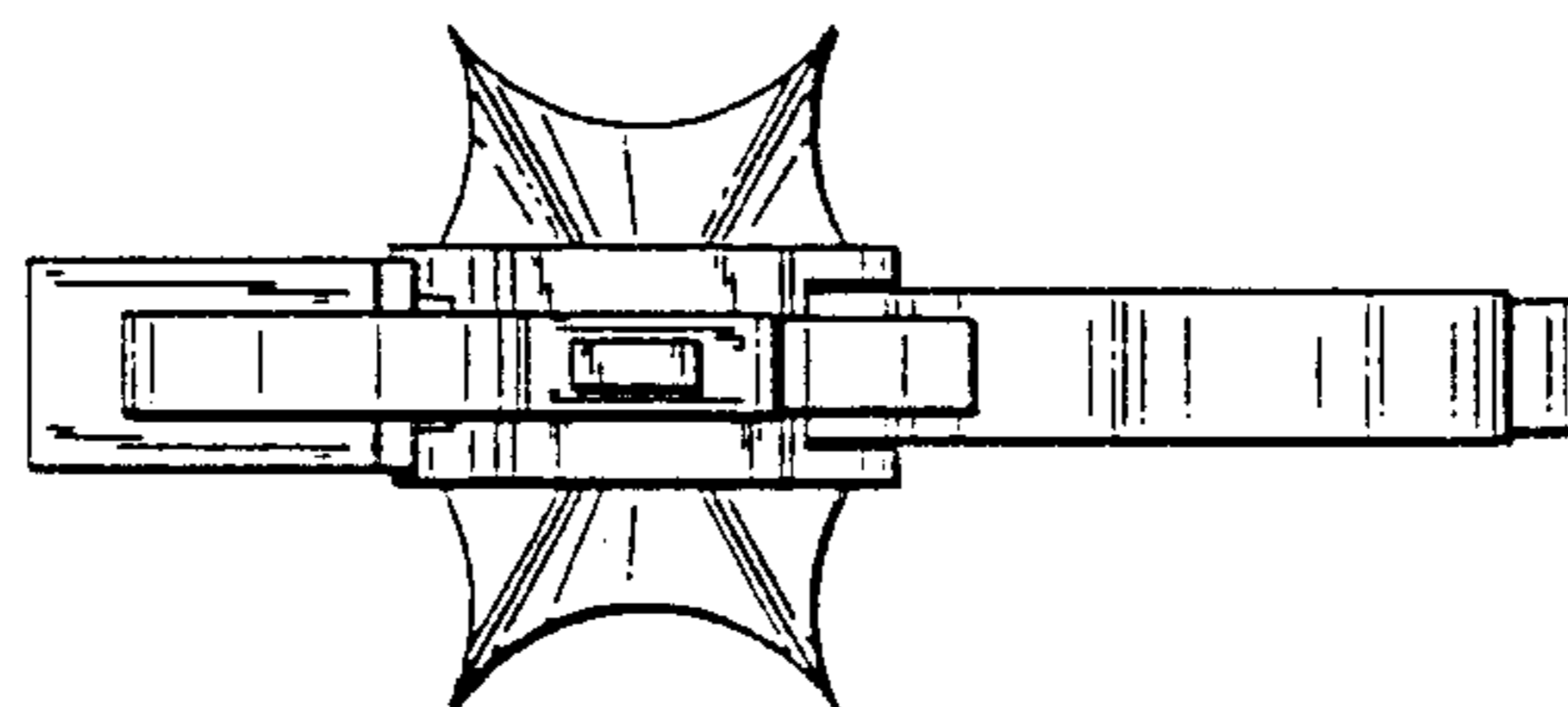

FIG. 6



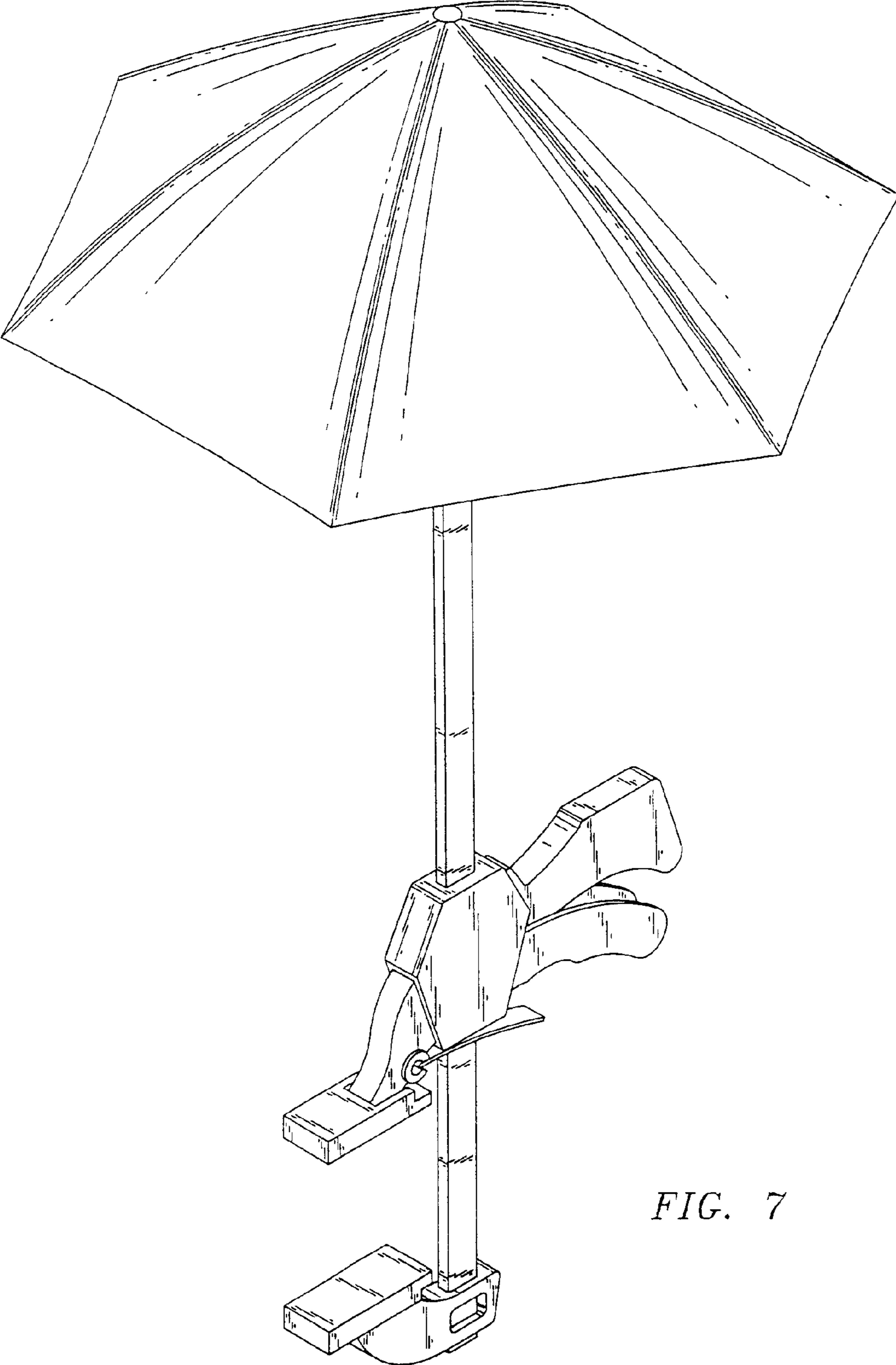

FIG. 7