



US00D510637S

(12) **United States Design Patent**
Chan

(10) **Patent No.:** **US D510,637 S**
(45) **Date of Patent:** **** Oct. 11, 2005**

(54) **FLASHLIGHT WITH TRANSLUCENT HOUSING**

(75) Inventor: **Peter Chan**, Kowloon (HK)

(73) Assignee: **Lumilite International Ltd.**, Hong Kong (HK)

(**) Term: **14 Years**

(21) Appl. No.: **29/214,721**

(22) Filed: **Oct. 6, 2004**

(51) **LOC (8) Cl.** **26-02**

(52) **U.S. Cl.** **D26/49**

(58) **Field of Search** D26/37-50; 362/157,
362/158, 171-174, 183-208

(56) **References Cited**

U.S. PATENT DOCUMENTS

D295,562 S	*	5/1988	Fazzina	D26/49
D335,192 S	*	4/1993	Abel	D26/49
D473,961 S	*	4/2003	Galli	D26/49
D486,936 S	*	2/2004	Shiu	D26/49
D493,240 S	*	7/2004	To	D26/49
D497,020 S	*	10/2004	Lee	D26/49

* cited by examiner

Primary Examiner—Marcus A. Jackson
(74) *Attorney, Agent, or Firm*—Schwabe, Williamson & Wyatt

(57) **CLAIM**

I claim an ornamental design for a flashlight with translucent housing, as shown and described.

DESCRIPTION

FIG. 1 illustrates a perspective view of a flashlight with translucent housing showing my new design;
FIG. 2 illustrates a rear view of the invention of FIG. 1;
FIG. 3 illustrates a front view of the invention of FIG. 1;
FIG. 4 illustrates a top elevational view of the invention of FIG. 1;
FIG. 5 illustrates a side elevational view of the invention of FIG. 1;
FIG. 6 illustrates a bottom elevational view of the invention of FIG. 1;
FIG. 7 illustrates a side view of the invention of FIG. 1 with a portion of the translucent material removed; and,
FIG. 8 illustrates a bottom view of the invention of FIG. 1 with a portion of the translucent material removed.

1 Claim, 3 Drawing Sheets

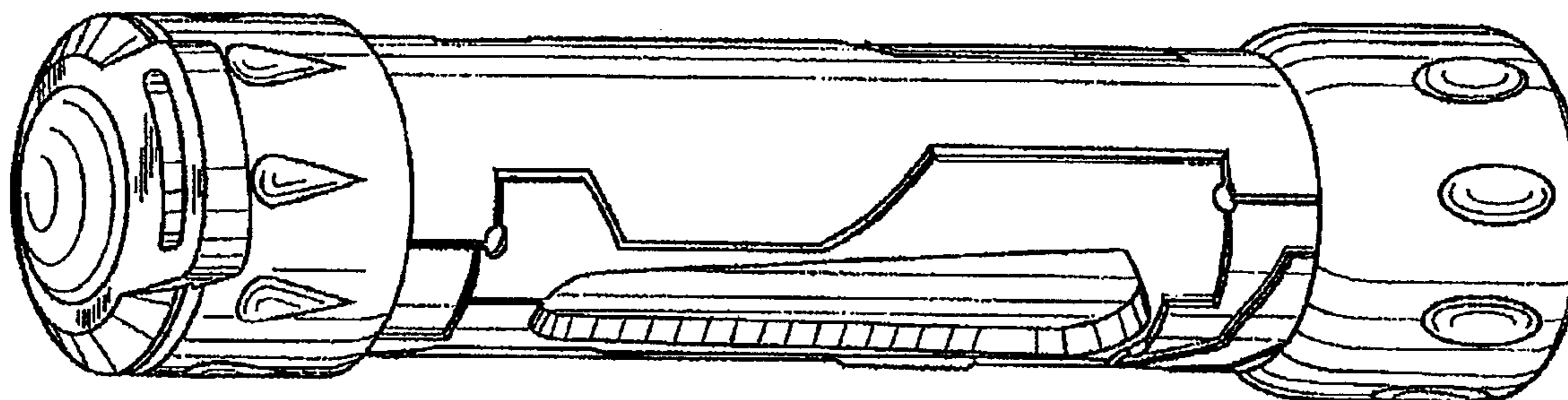

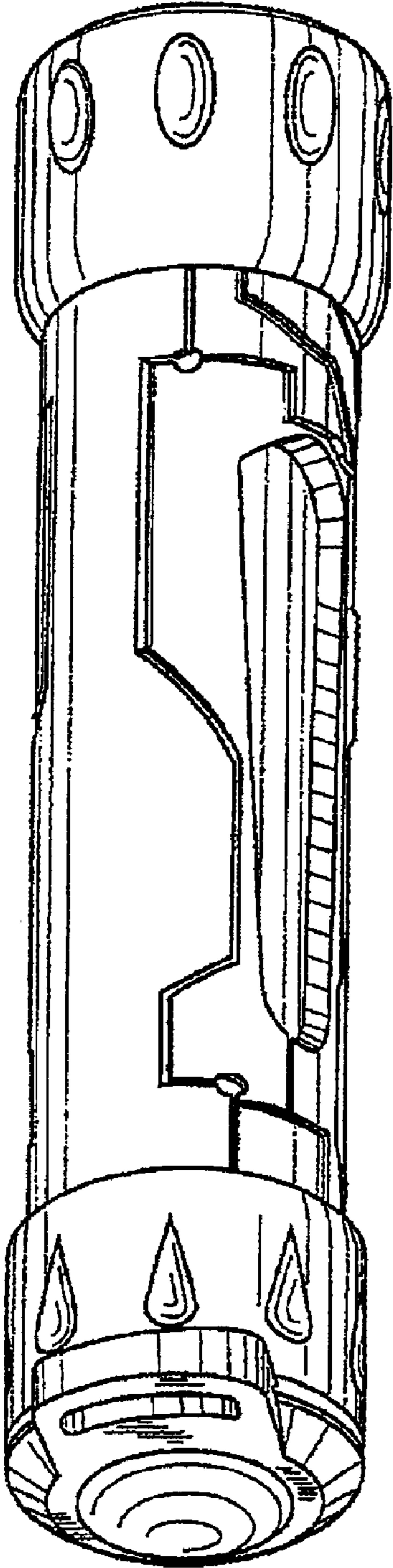

FIG. 1

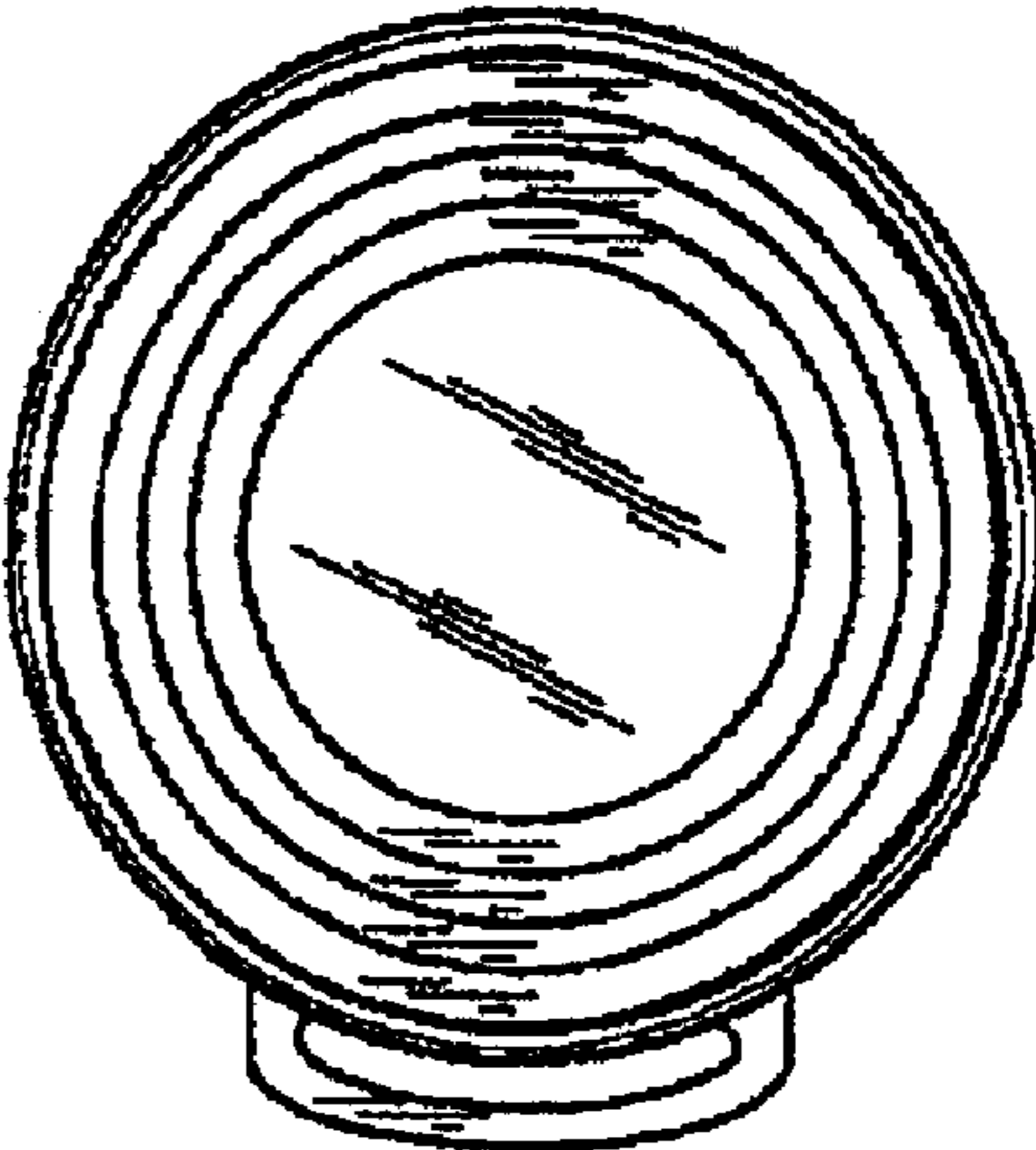

FIG. 3

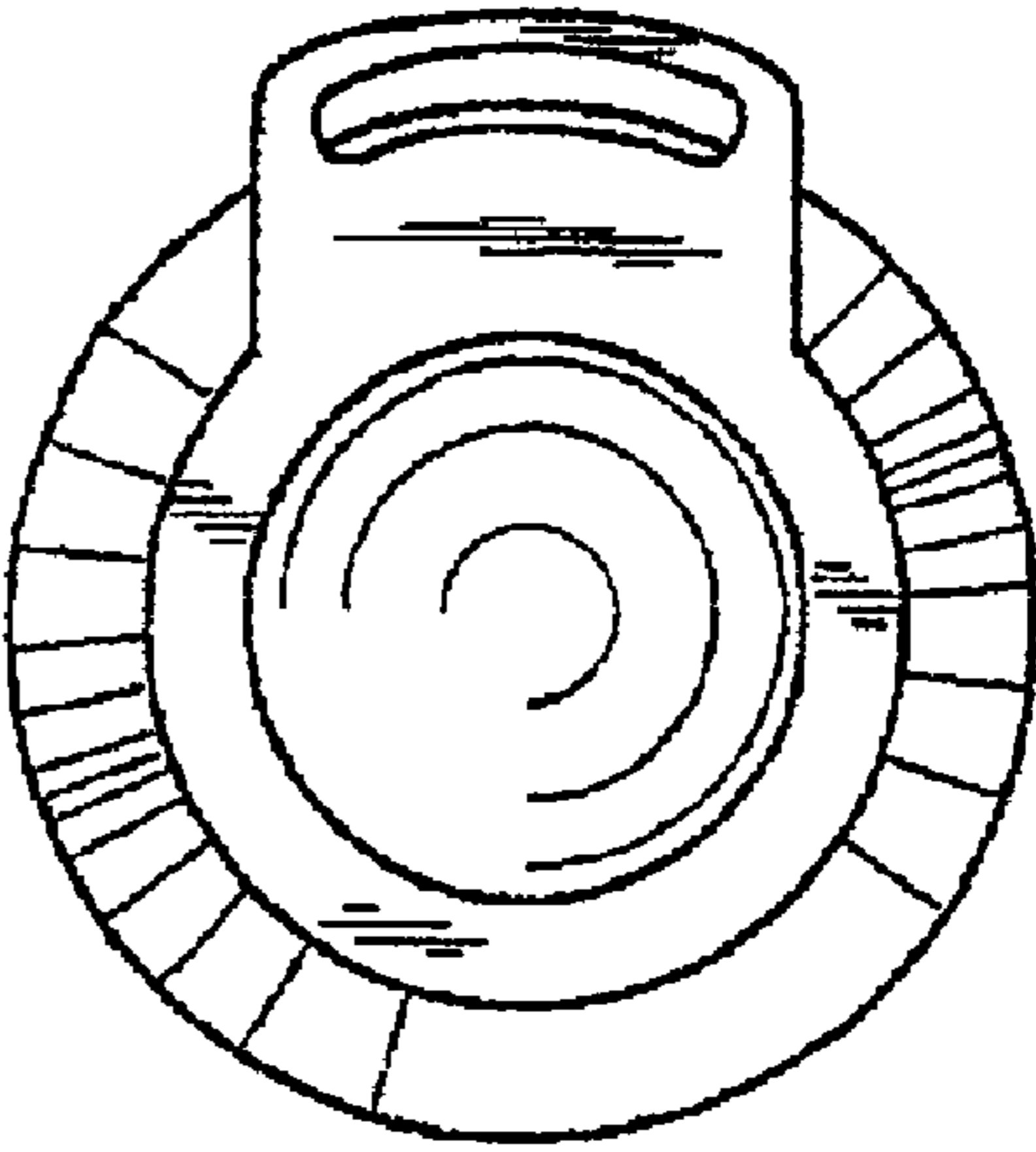
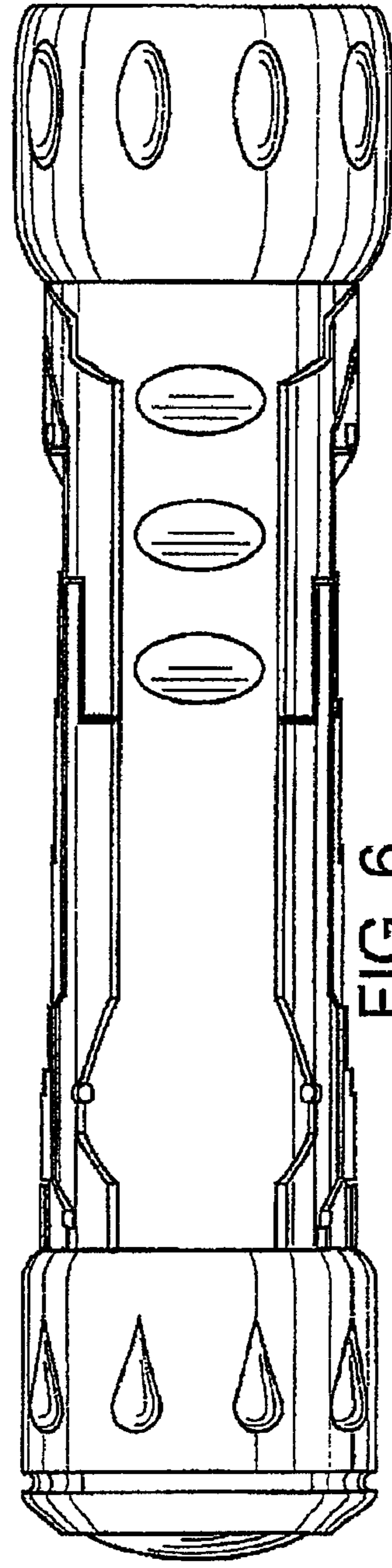
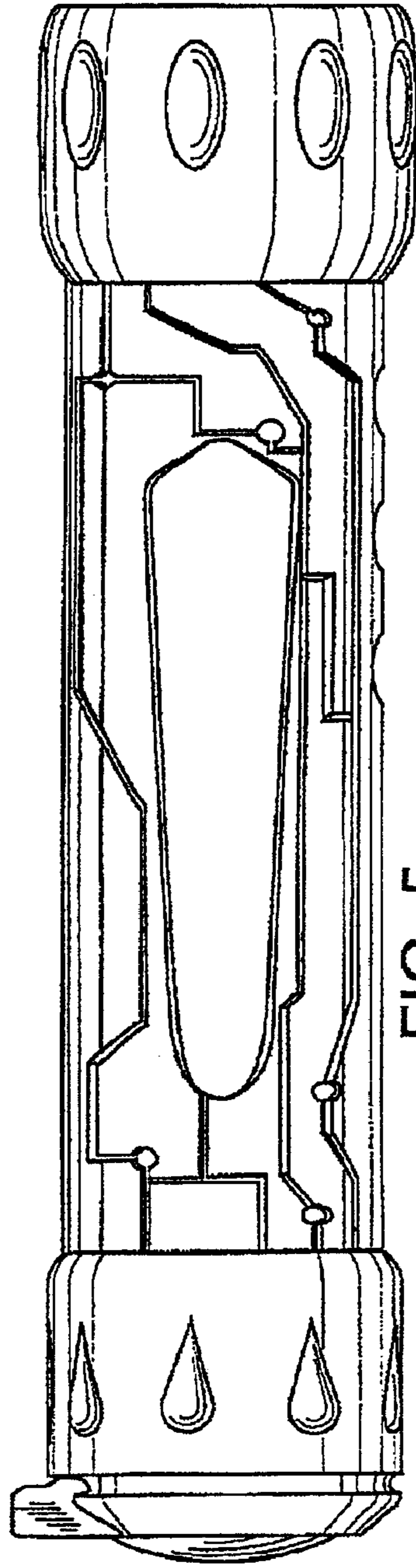
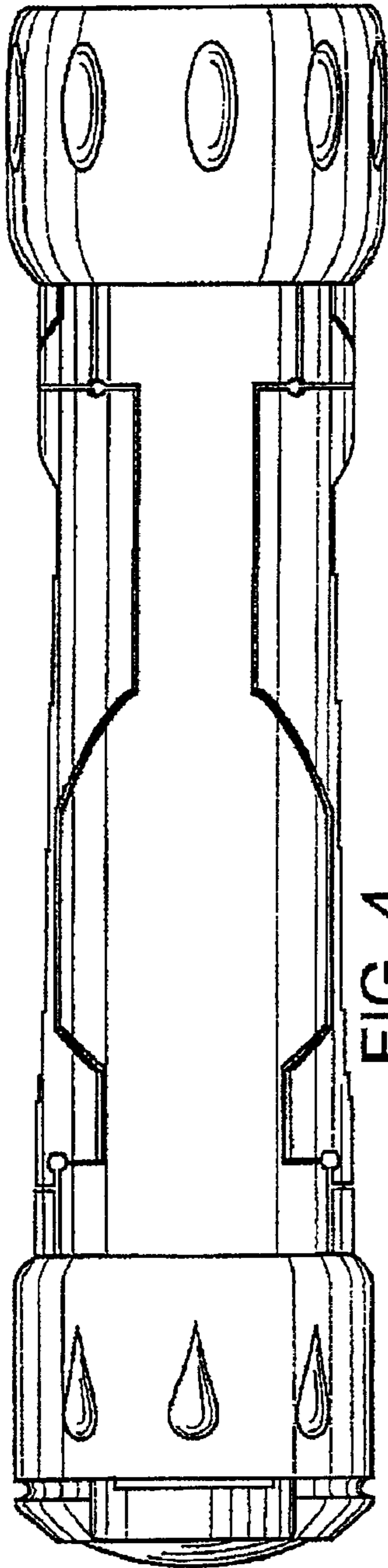

FIG. 2



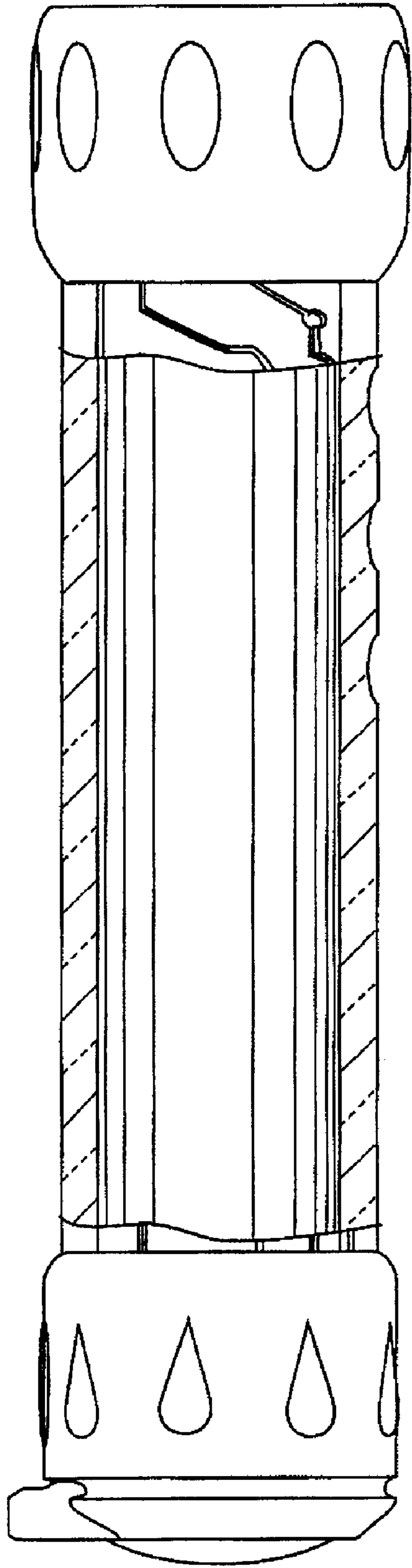

FIG. 7

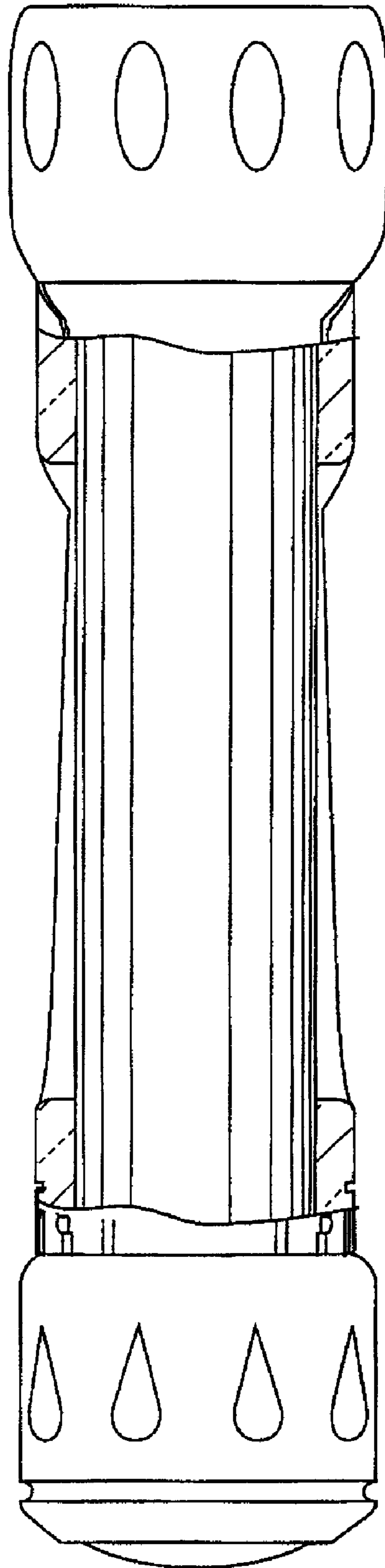

FIG. 8