



US00D510456S

(12) **United States Design Patent**
Smith

(10) **Patent No.:** **US D510,456 S**

(45) **Date of Patent:** **** Oct. 4, 2005**

(54) **COMBINATION LIGHTER AND CUTTER**

(75) Inventor: **Andrew D. Smith**, Pascoag, RI (US)

(73) Assignee: **Colibri Corporation**, Providence, RI (US)

(**) Term: **14 Years**

(21) Appl. No.: **29/221,345**

(22) Filed: **Jan. 13, 2005**

(51) **LOC (8) Cl.** **27-05**

(52) **U.S. Cl.** **D27/143; D27/157**

(58) **Field of Search** **D27/141-143, D27/152-161; 431/151, 153, 253-255, 273-277; 131/248, 249**

(56) **References Cited**

U.S. PATENT DOCUMENTS

D469,919 S	*	2/2003	Lin	D27/141
D492,061 S	*	6/2004	Reynolds	D27/143
D503,013 S	*	3/2005	Chen	D27/154

* cited by examiner

Primary Examiner—Jennifer Rivard

(74) *Attorney, Agent, or Firm*—Salter & Michaelson

(57) **CLAIM**

I claim the ornamental design for a combination lighter and cutter, as shown and described.

DESCRIPTION

FIG. 1 is a perspective view of a combination lighter and cutter showing my new design;

FIG. 2 is a right side elevational view thereof;

FIG. 3 is a left side elevational view thereof;

FIG. 4 is a top plan view thereof;

FIG. 5 is a bottom plan view thereof;

FIG. 6 is a rear elevational view thereof;

FIG. 7 is a front elevational view thereof;

FIG. 8 is a perspective view thereof with the cover in its opened position; and,

FIG. 9 is a fragmentary perspective view showing the cutter in its operative position.

The portion shown in broken lines in FIG. 8 is included for illustrative purposes only and forms no part of the claimed design.

1 Claim, 5 Drawing Sheets

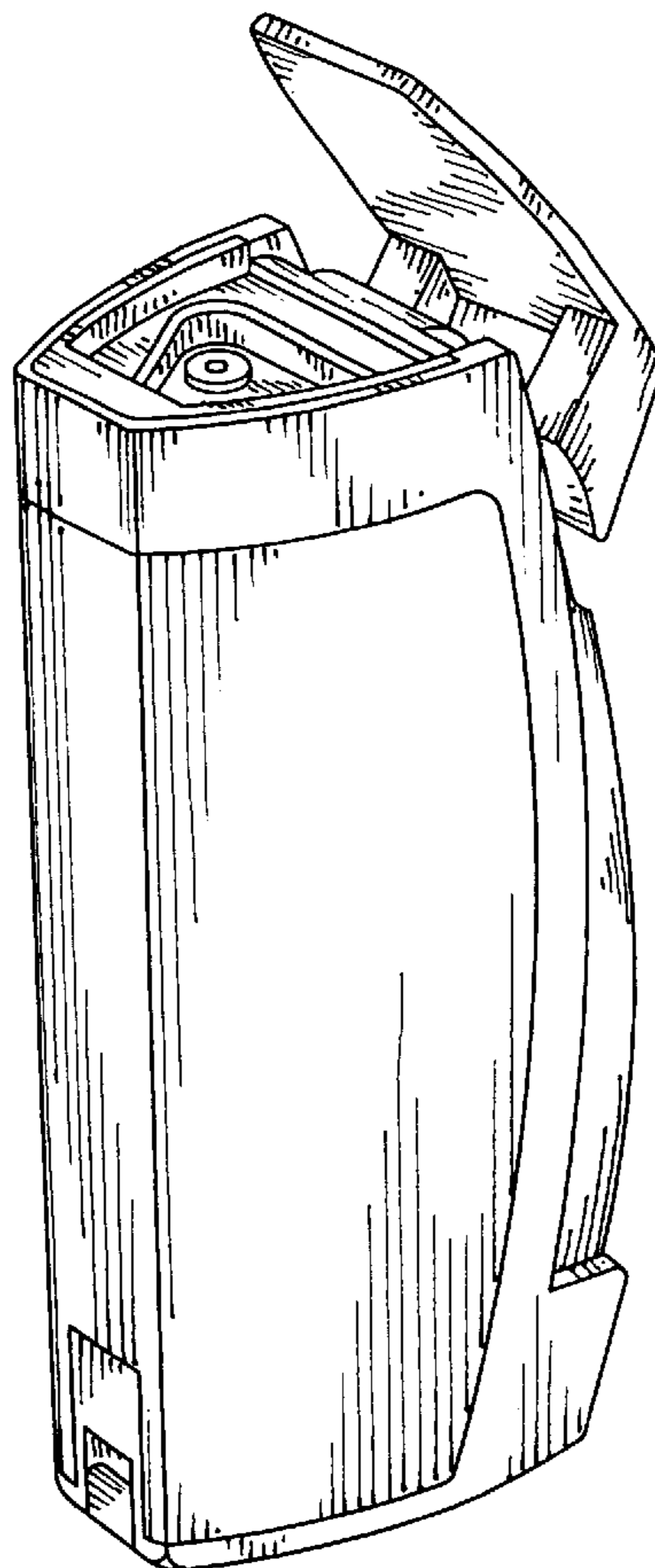

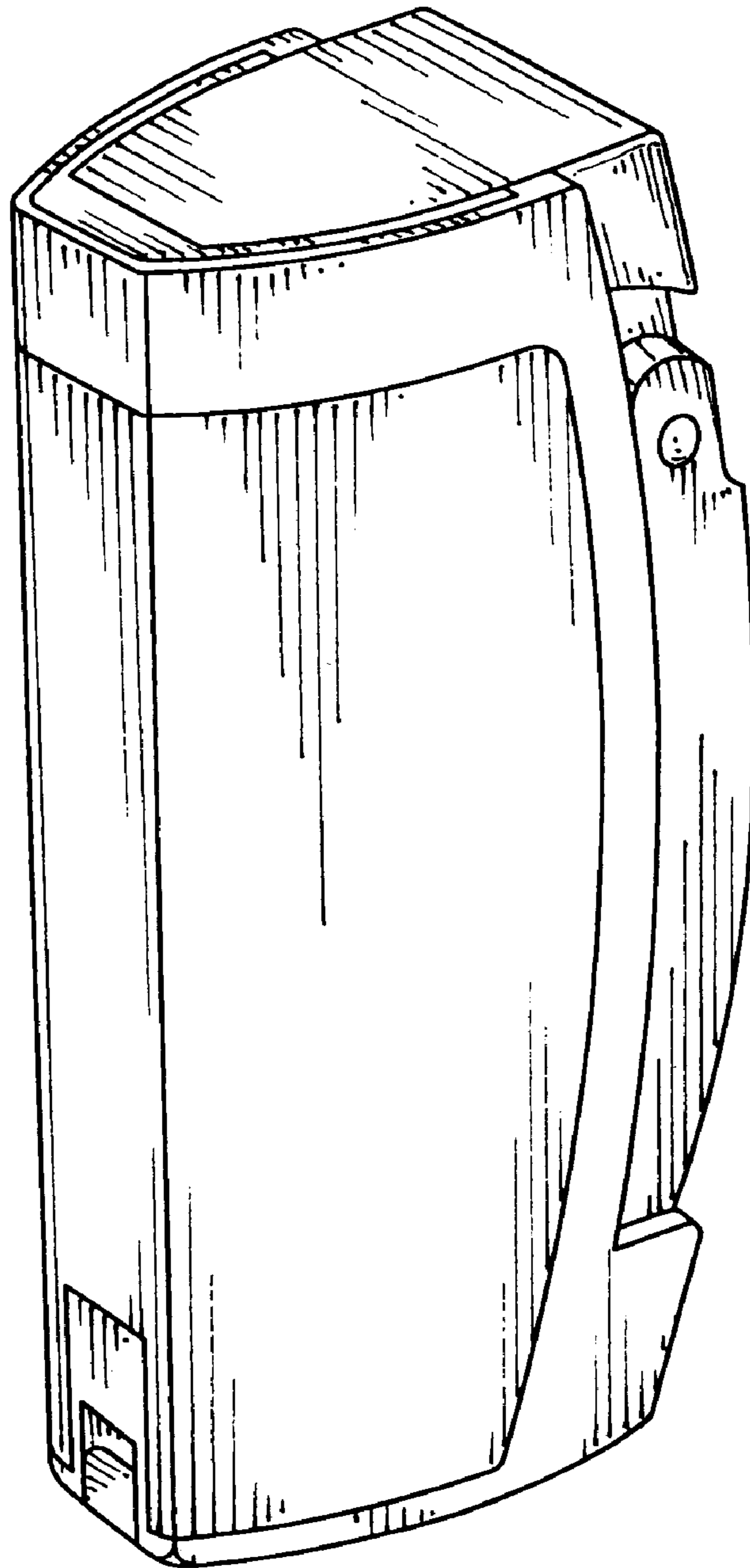

FIG. 1

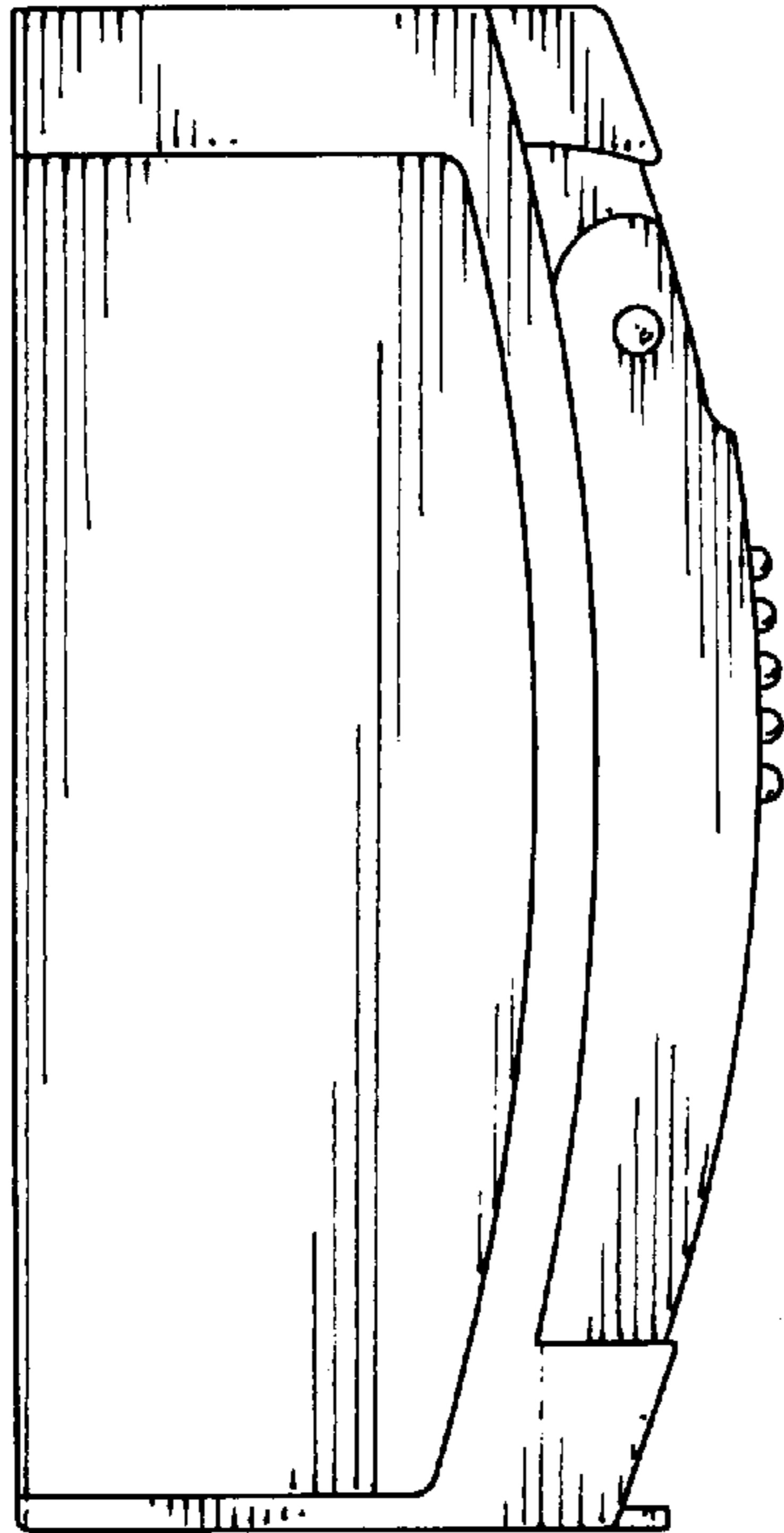

FIG. 2

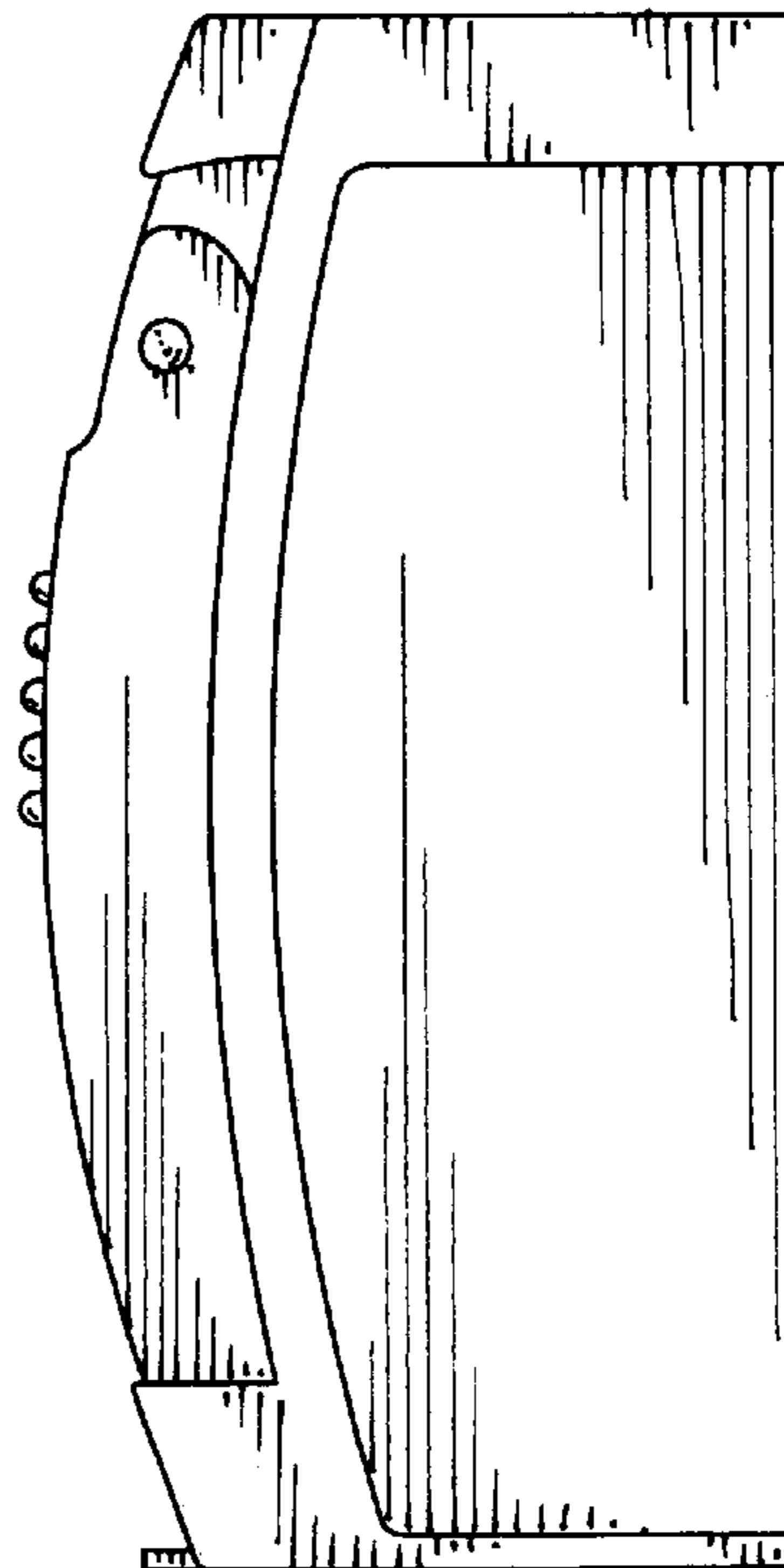

FIG. 3

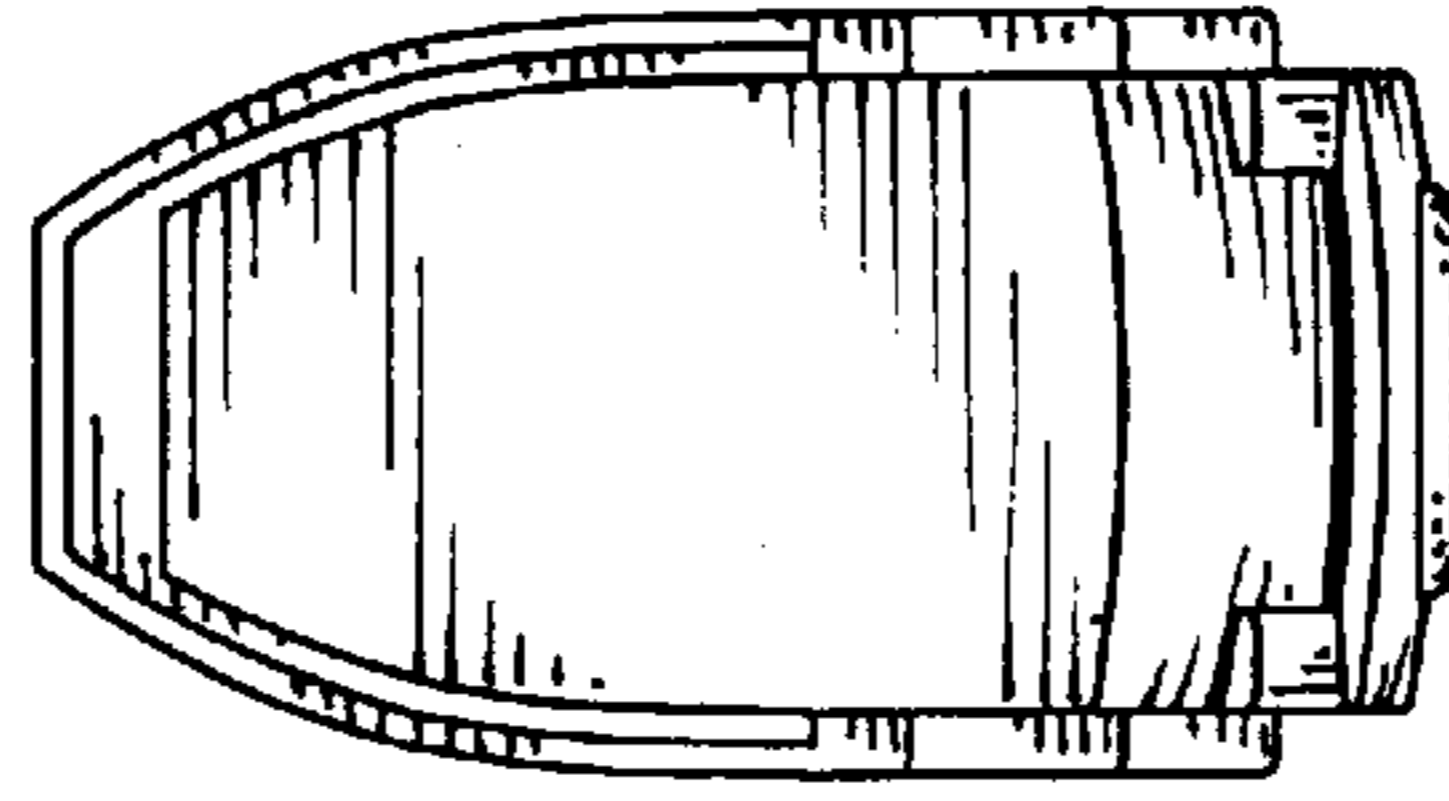

FIG. 4

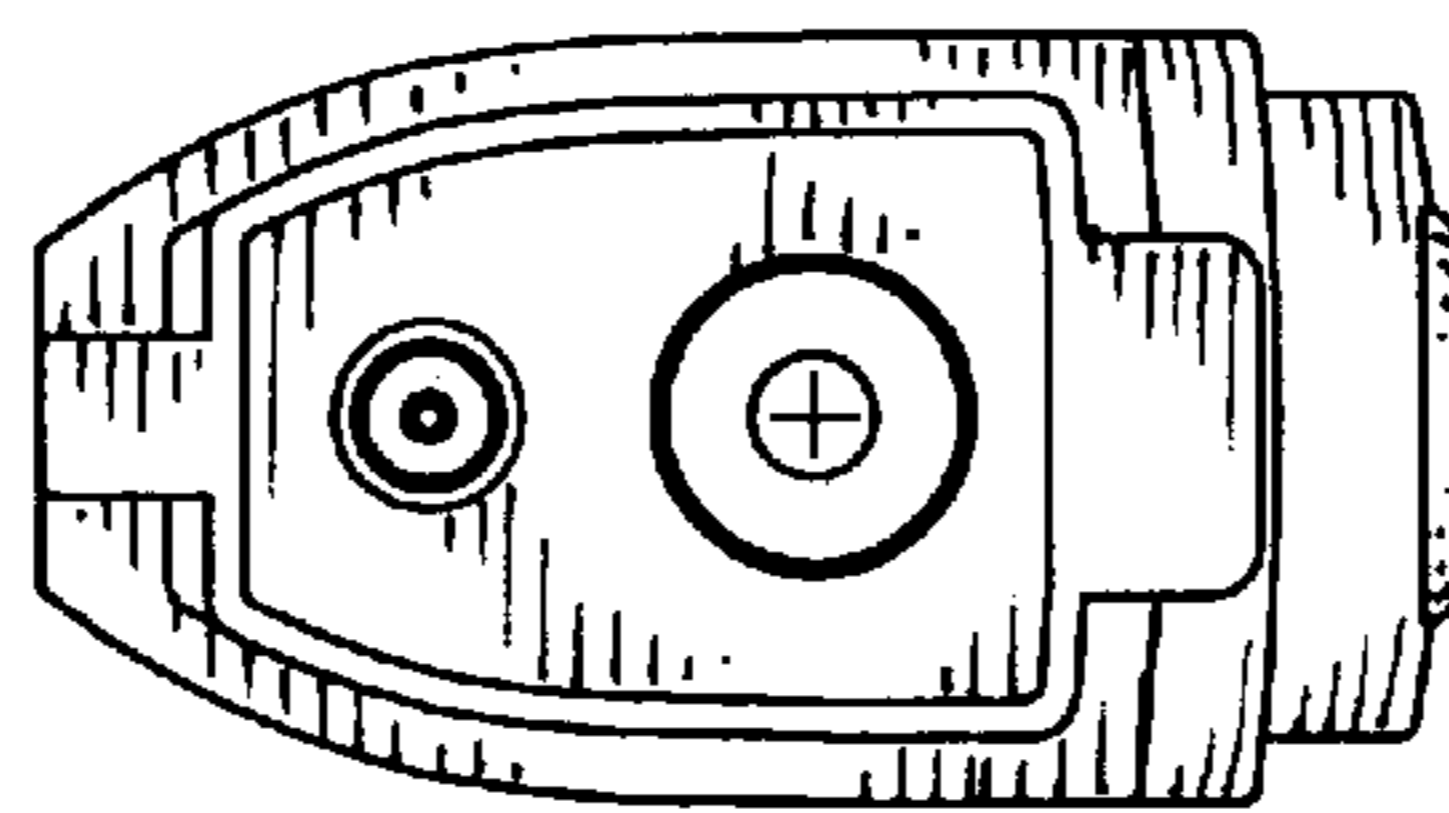

FIG. 5

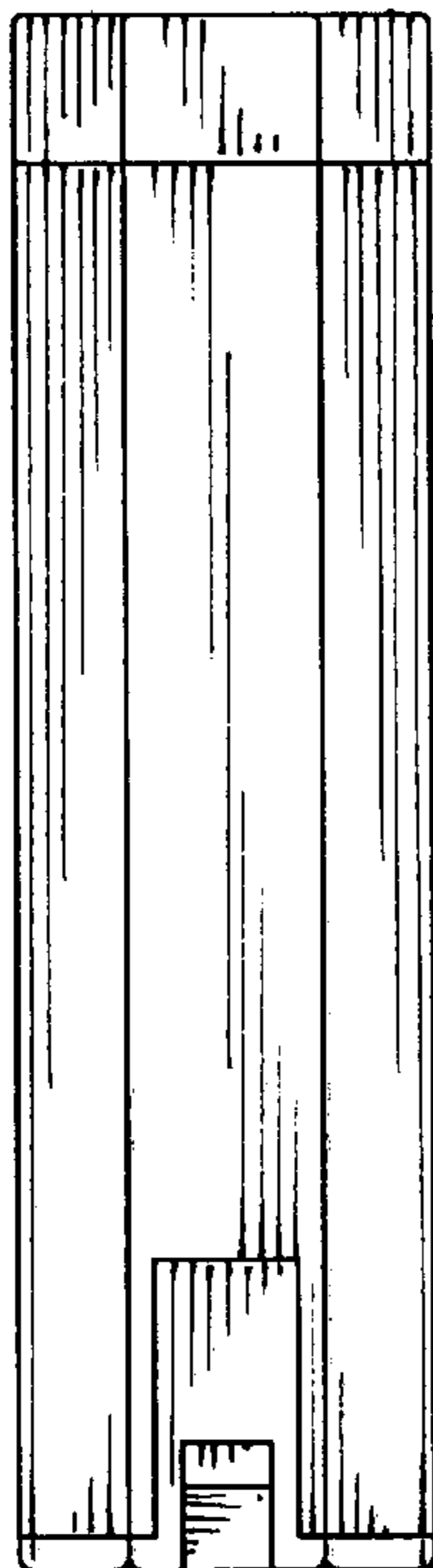

FIG. 6

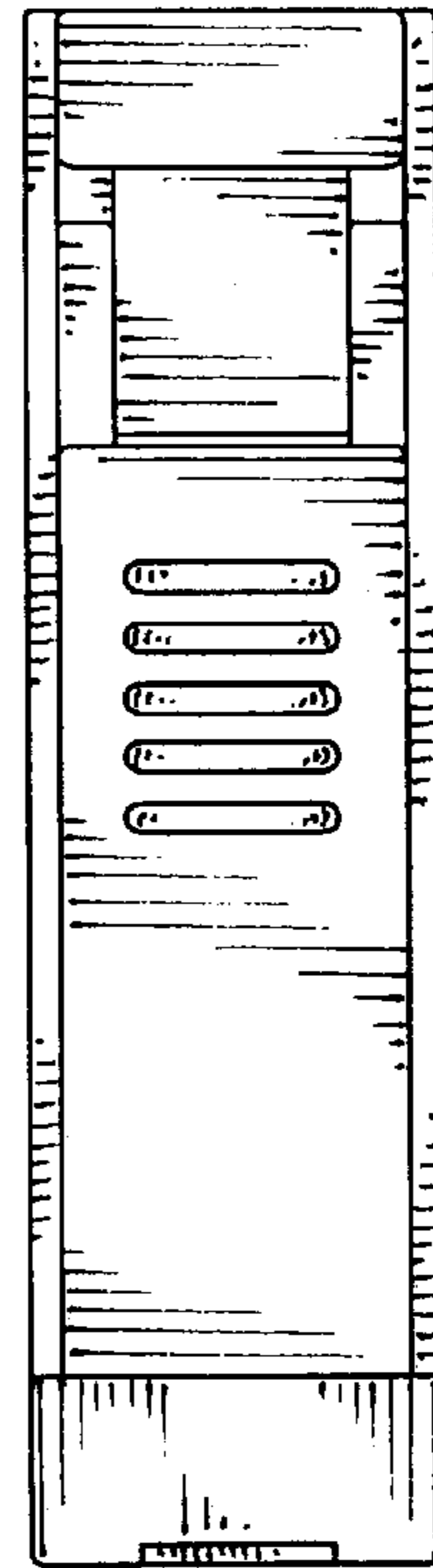

FIG. 7

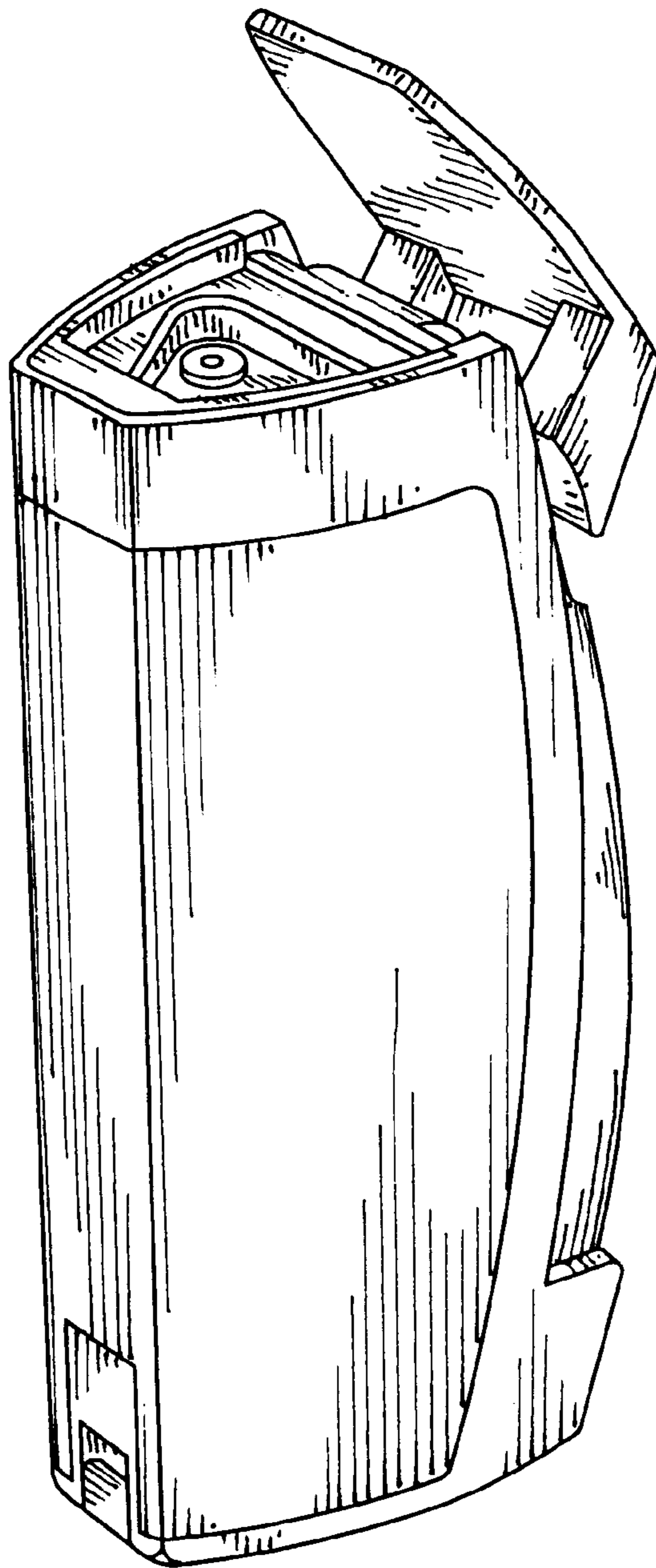

FIG. 8

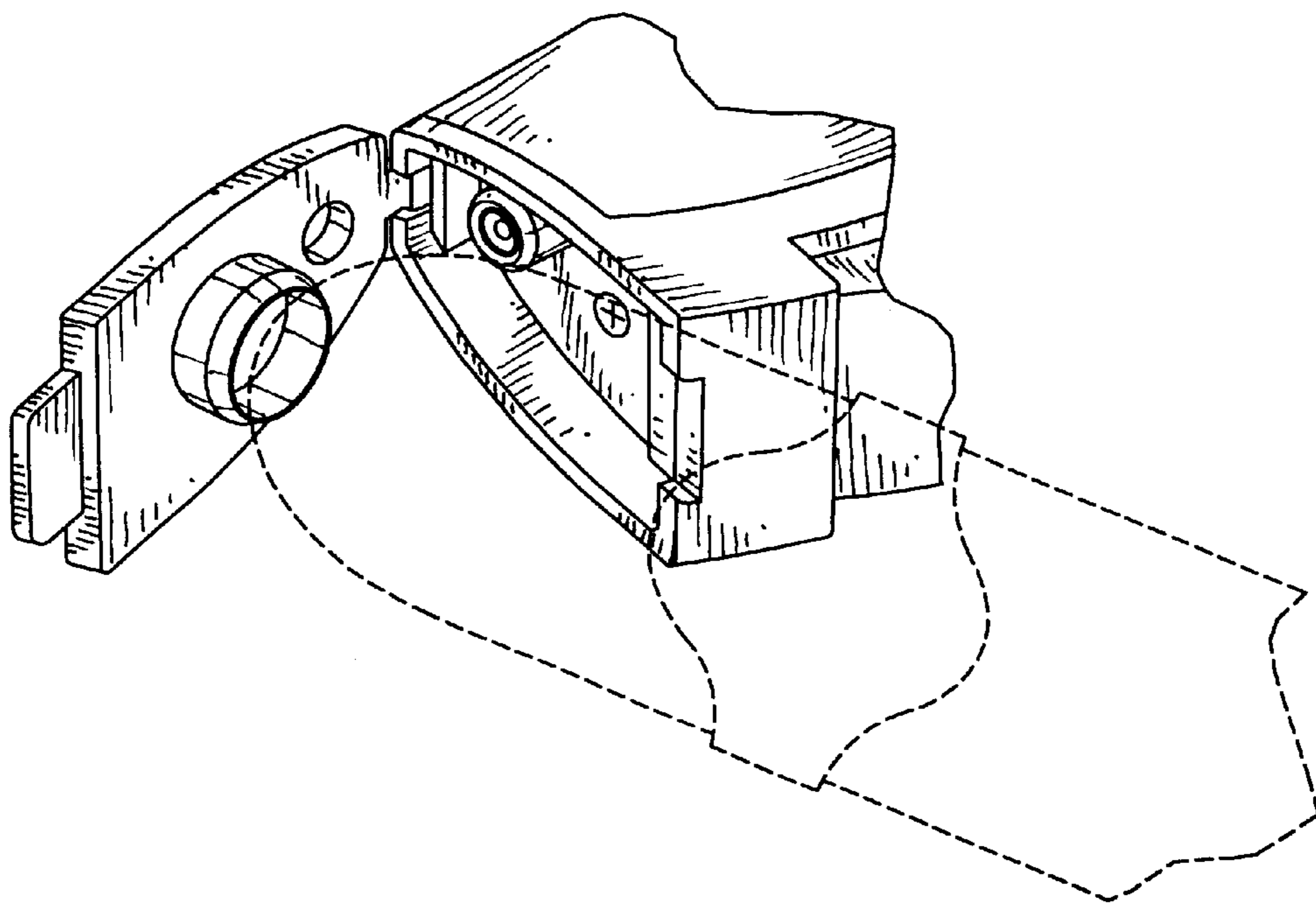

FIG. 9