



US00D510418S

(12) **United States Design Patent**  
**Painter**

(10) **Patent No.:** **US D510,418 S**  
(45) **Date of Patent:** **\*\* Oct. 4, 2005**

(54) **DOUBLE BOWL SINK WITH RECEPTACLE**

D401,310 S 11/1998 Ta Chang

(75) **Inventor:** **Michael J. Painter**, Reynoldsburg, OH (US)

\* cited by examiner

*Primary Examiner*—Robert A. Delehanty

(73) **Assignee:** **American Standard International Inc.**, New York, NY (US)

(57) **CLAIM**

(\*\*) **Term:** **14 Years**

The ornamental design for a double bowl sink with receptacle, as shown and described.

(21) **Appl. No.:** **29/185,489**

**DESCRIPTION**

(22) **Filed:** **Jun. 27, 2003**

(51) **LOC (8) Cl.** ..... **23-02**

(52) **U.S. Cl.** ..... **D23/290**

(58) **Field of Search** ..... D23/270-273,  
D23/284-286, 293.1, 303, 308, 289, 292,  
290; 4/661-666, 619, 624, 630, 519, 638,  
643, 515

FIG. 1 is a perspective view of a double bowl sink with receptacle showing my new design;  
FIG. 2 is a top plan view thereof;  
FIG. 3 is a front elevational view thereof;  
FIG. 4 is the left side elevational view thereof;  
FIG. 5 is a right side elevational view thereof;  
FIG. 6 is a rear elevational view thereof; and,  
FIG. 7 is a bottom plan view thereof.

The broken line showing of plumbing holes is for illustrative purposes only and forms no part of the claimed design.

(56) **References Cited**

**U.S. PATENT DOCUMENTS**

D323,878 S \* 2/1992 Sauter et al. .... D23/290

**1 Claim, 6 Drawing Sheets**

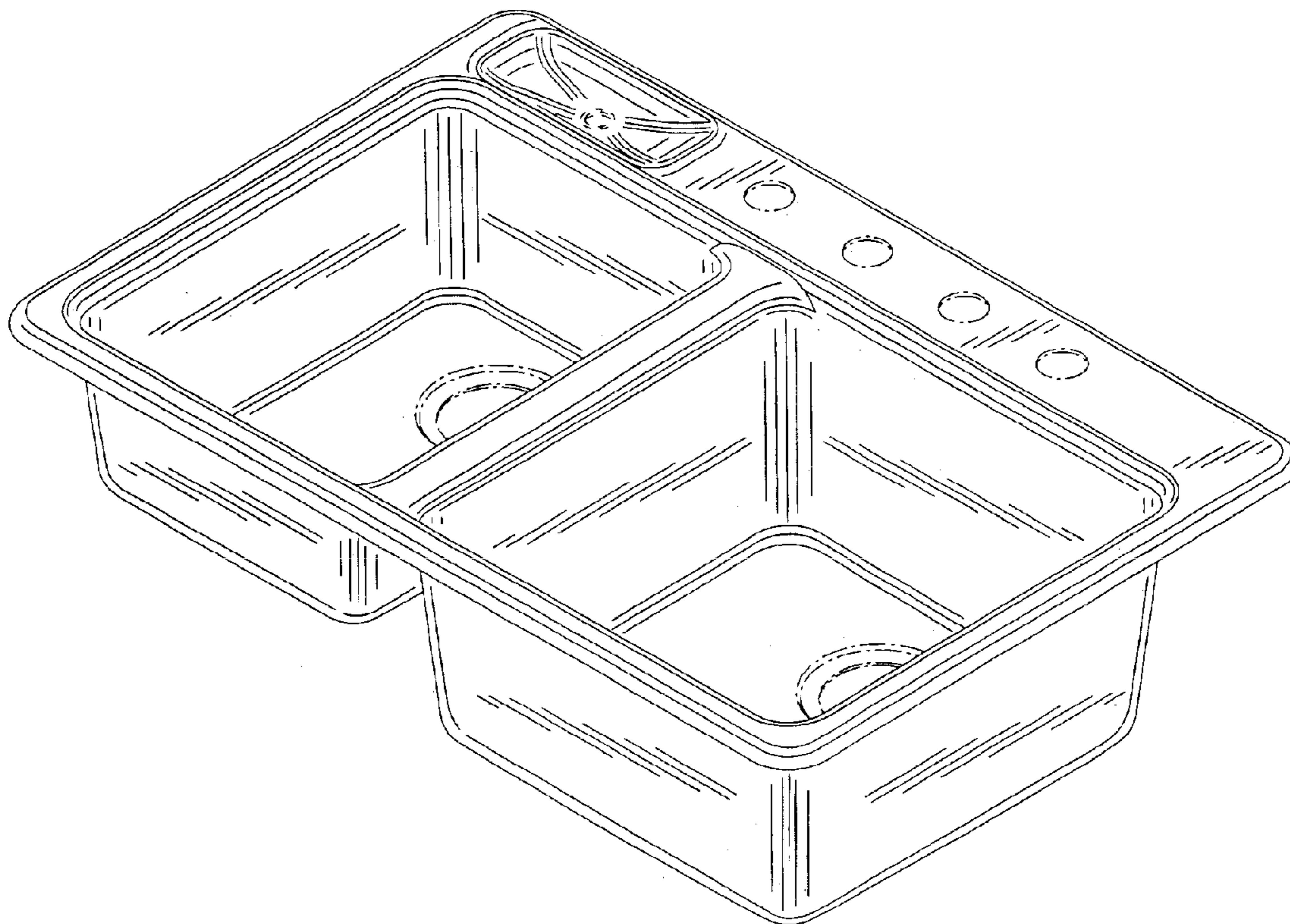

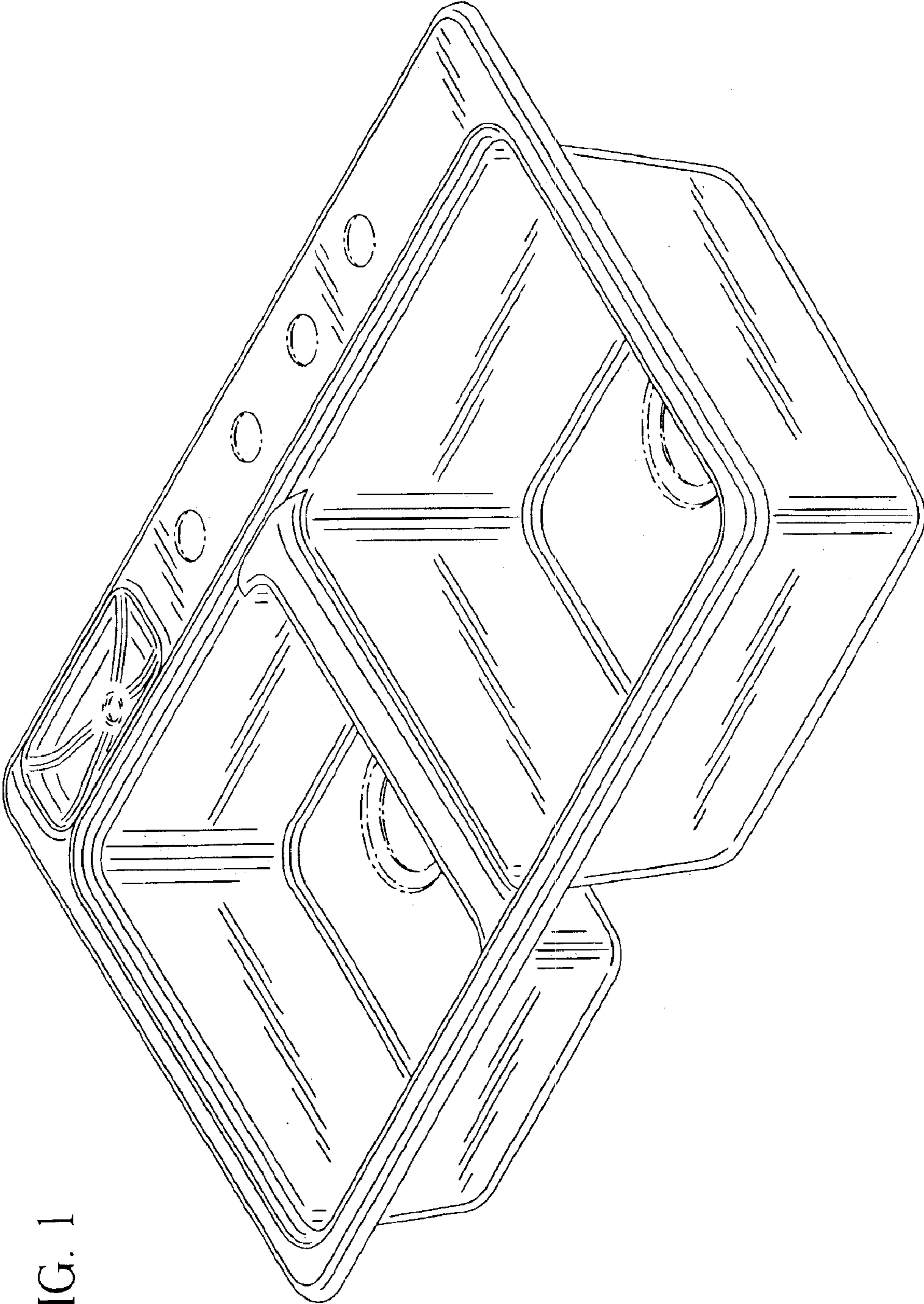

FIG. 1

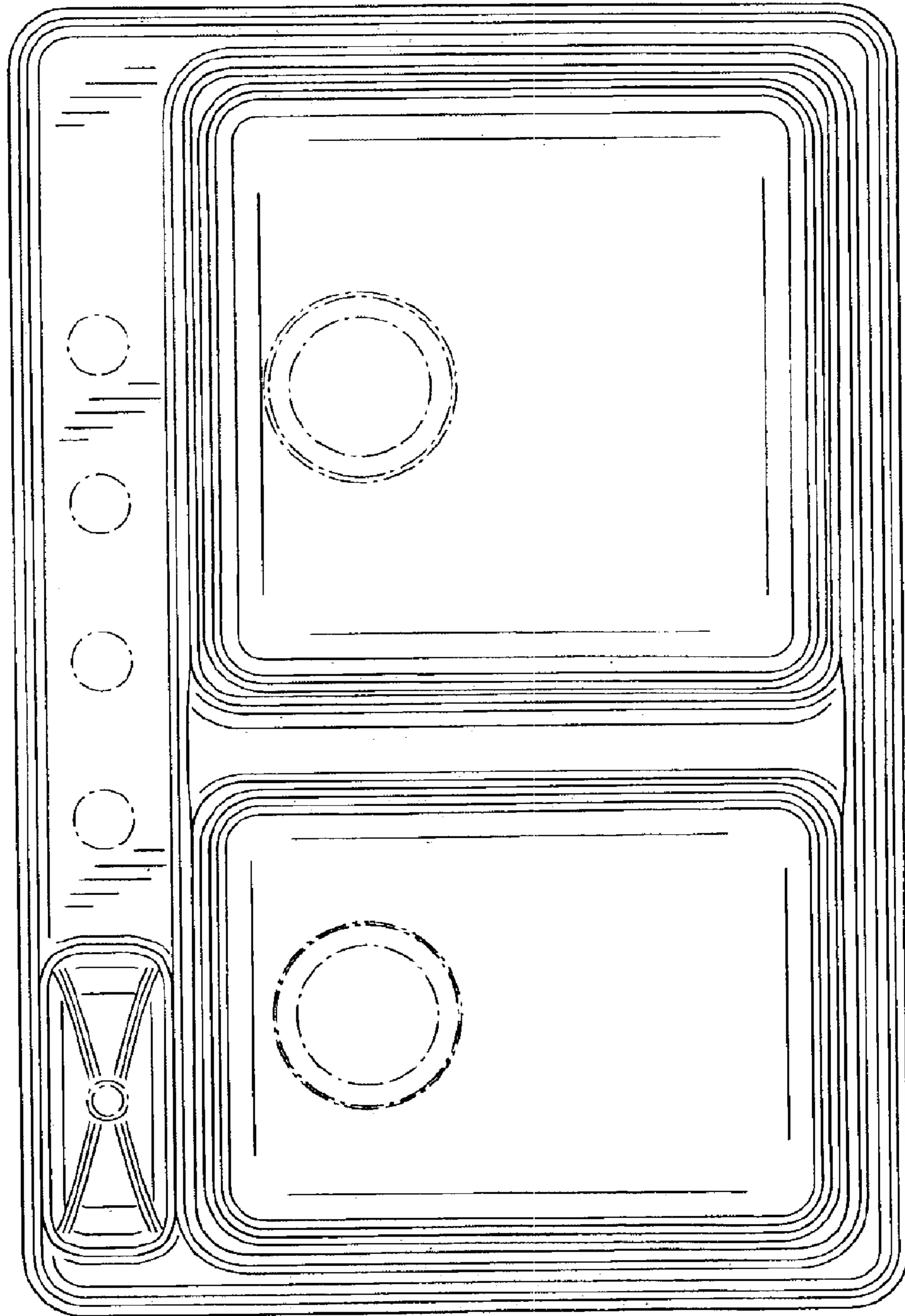

FIG. 2

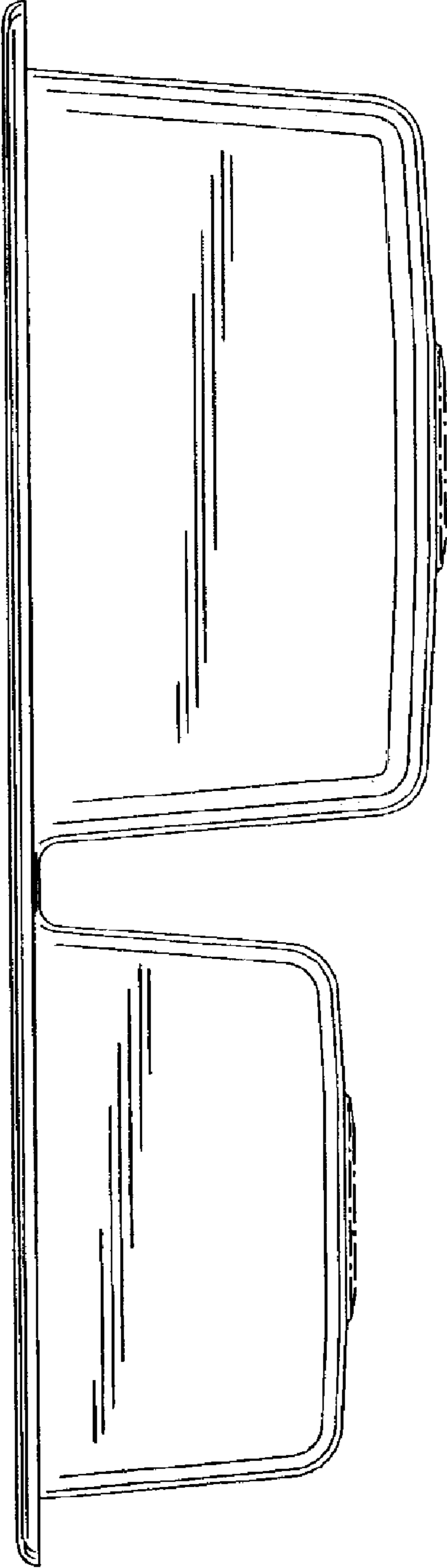

FIG. 3



FIG. 5

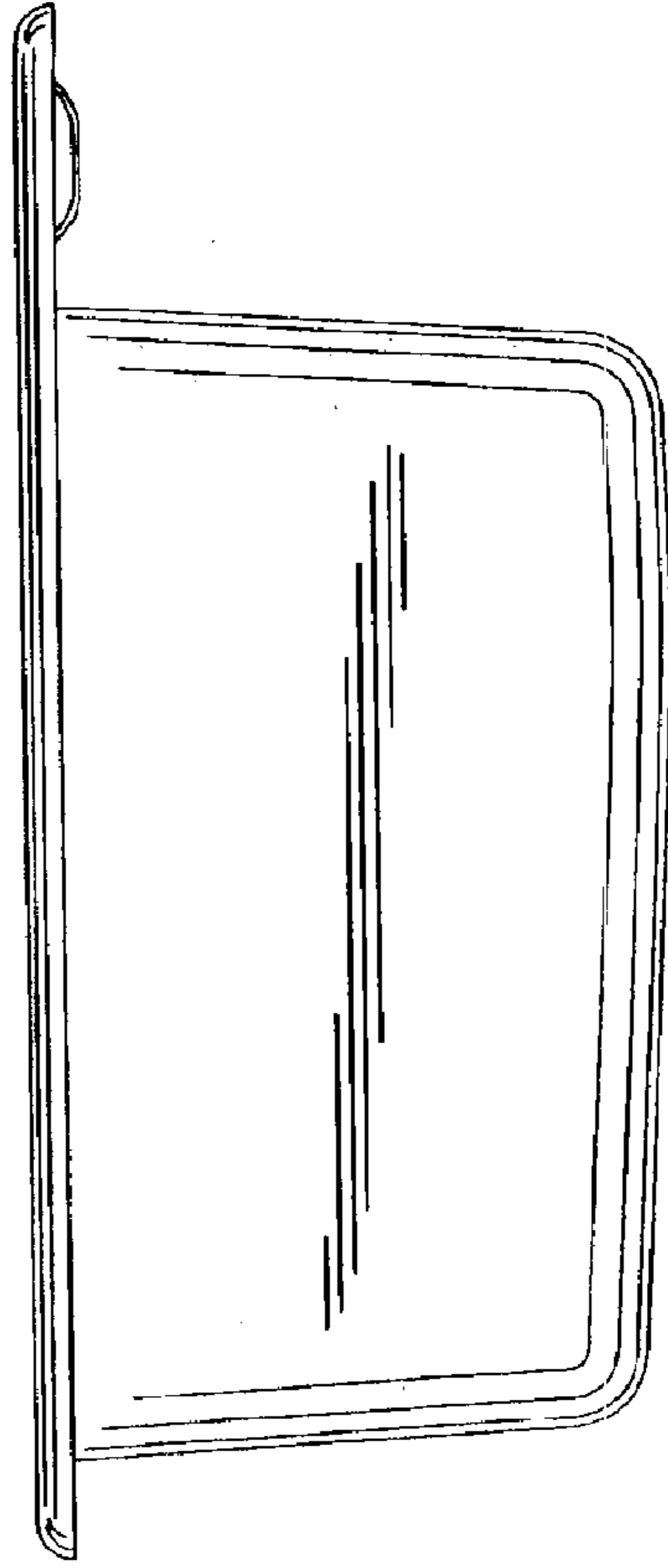

FIG. 4



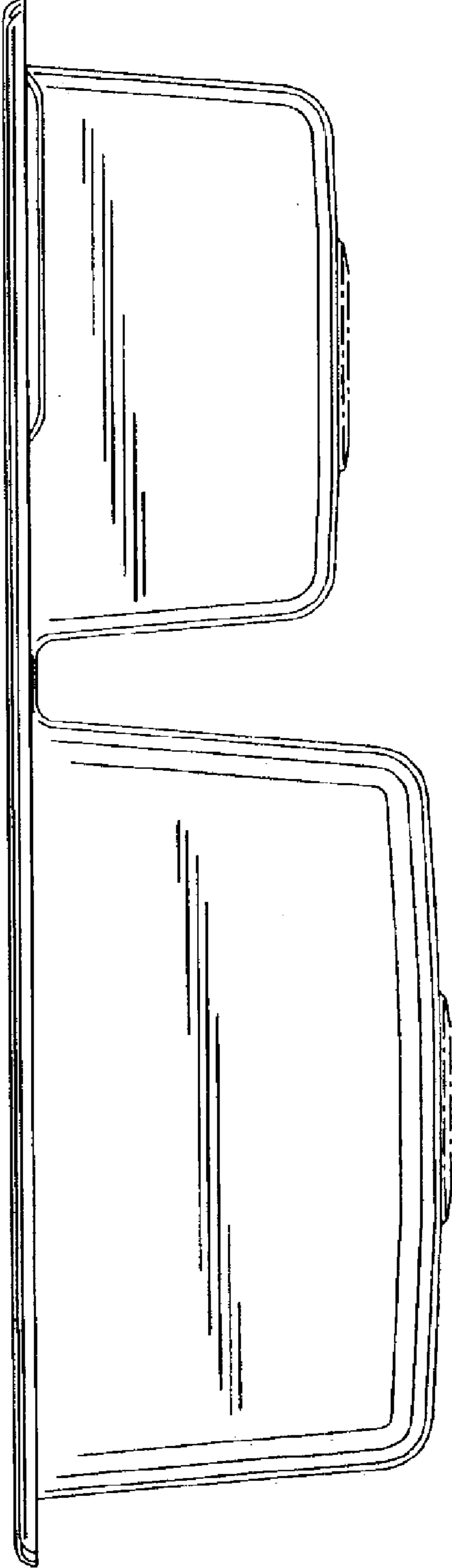

FIG. 6

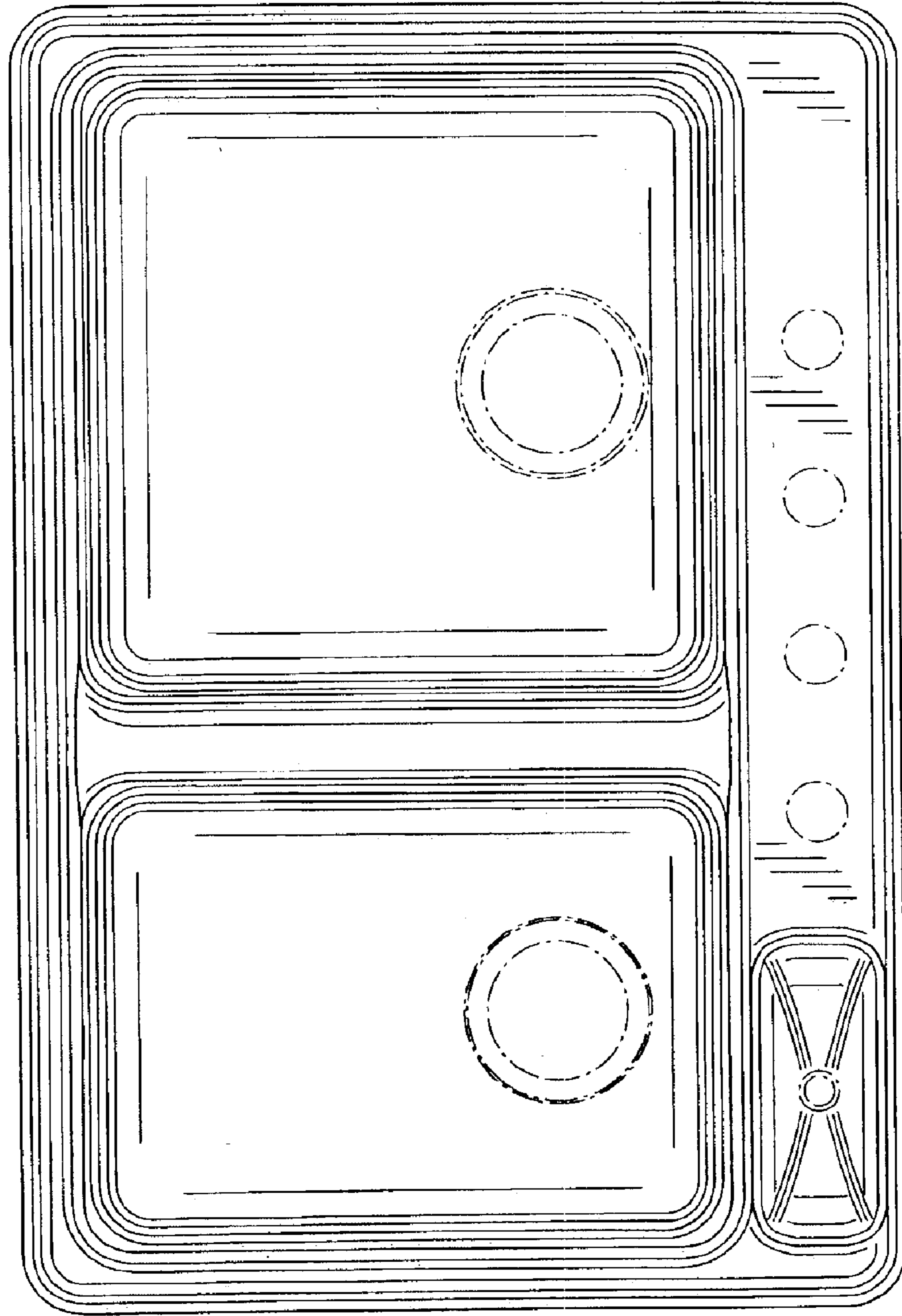

FIG. 7