

US00D510365S

(12) **United States Design Patent**
Yoshida et al.

(10) **Patent No.:** **US D510,365 S**
(45) **Date of Patent:** **** Oct. 4, 2005**

(54) **SPROCKET PART FOR A BULLDOZER**

D476,342 S * 6/2003 Yoshida et al. D15/28
D476,666 S * 7/2003 Yoshida et al. D15/28
D484,149 S * 12/2003 Hannan et al. D15/28

(75) Inventors: **Tsuyoshi Yoshida**, Osaka (JP); **Teiji Yamamoto**, Osaka (JP); **Shota Murakami**, Osaka (JP); **Kenji Kohriyama**, Osaka (JP)

* cited by examiner

Primary Examiner—Mitchell Siegel
(74) *Attorney, Agent, or Firm*—Manabu Kanesaka

(73) Assignee: **Komatsu Ltd.**, Tokyo (JP)

(57) **CLAIM**

(**) Term: **14 Years**

The ornamental design for a sprocket part for a bulldozer, as shown and described.

(21) Appl. No.: **29/190,889**

DESCRIPTION

(22) Filed: **Sep. 30, 2003**

(51) **LOC (8) Cl.** **15-03**

(52) **U.S. Cl.** **D15/28**

(58) **Field of Search** D15/22–28, 10;
D12/604; 152/209, 523; 180/9.1; 305/185–187,
199, 7, 31, 54, 19

FIG. 1 is a top plan view of a sprocket part for a bulldozer showing our new design;
FIG. 2 is a front view thereof;
FIG. 3 is a bottom view thereof;
FIG. 4 is a right side view thereof, a left side view being symmetrical to the right side view;
FIG. 5 is a rear view thereof;
FIG. 6 is a perspective view thereof;
FIG. 7 is a sectional view thereof taken along line 7—7 in FIG. 2; and,
FIG. 8 is a sectional view thereof taken along line 8—8 in FIG. 2.

(56) **References Cited**

U.S. PATENT DOCUMENTS

5,373,310 A * 12/1994 Ichimura et al. 345/98
D365,827 S * 1/1996 Chandler D15/28
5,573,310 A * 11/1996 Rollinson 301/43
D435,565 S * 12/2000 Barani D15/28

1 Claim, 4 Drawing Sheets

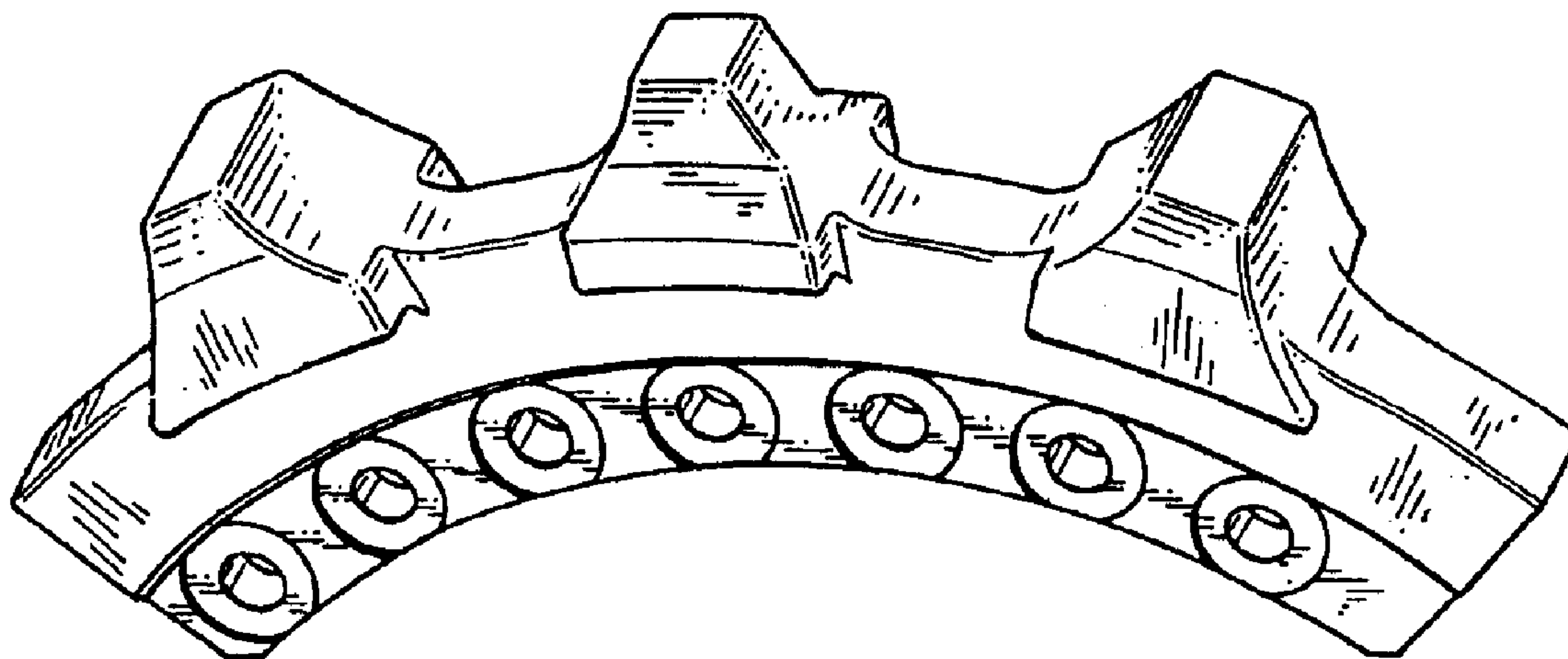

Fig. 1

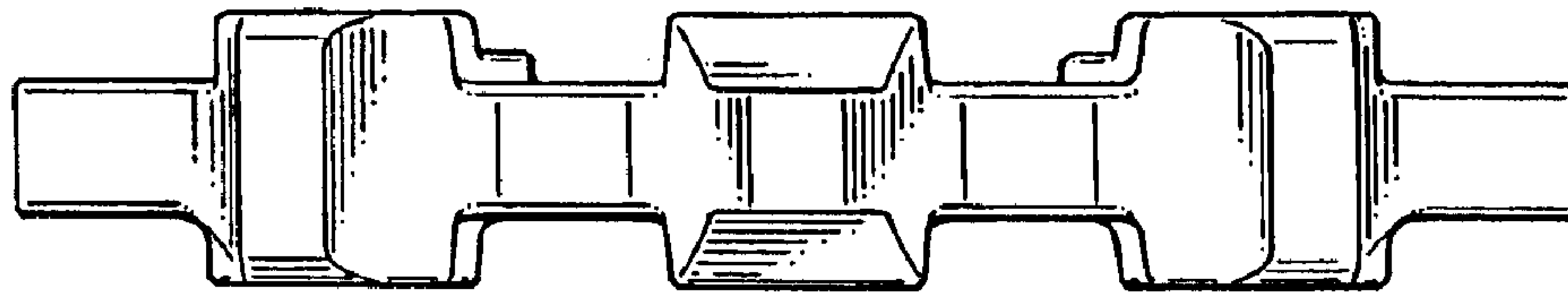

Fig. 2

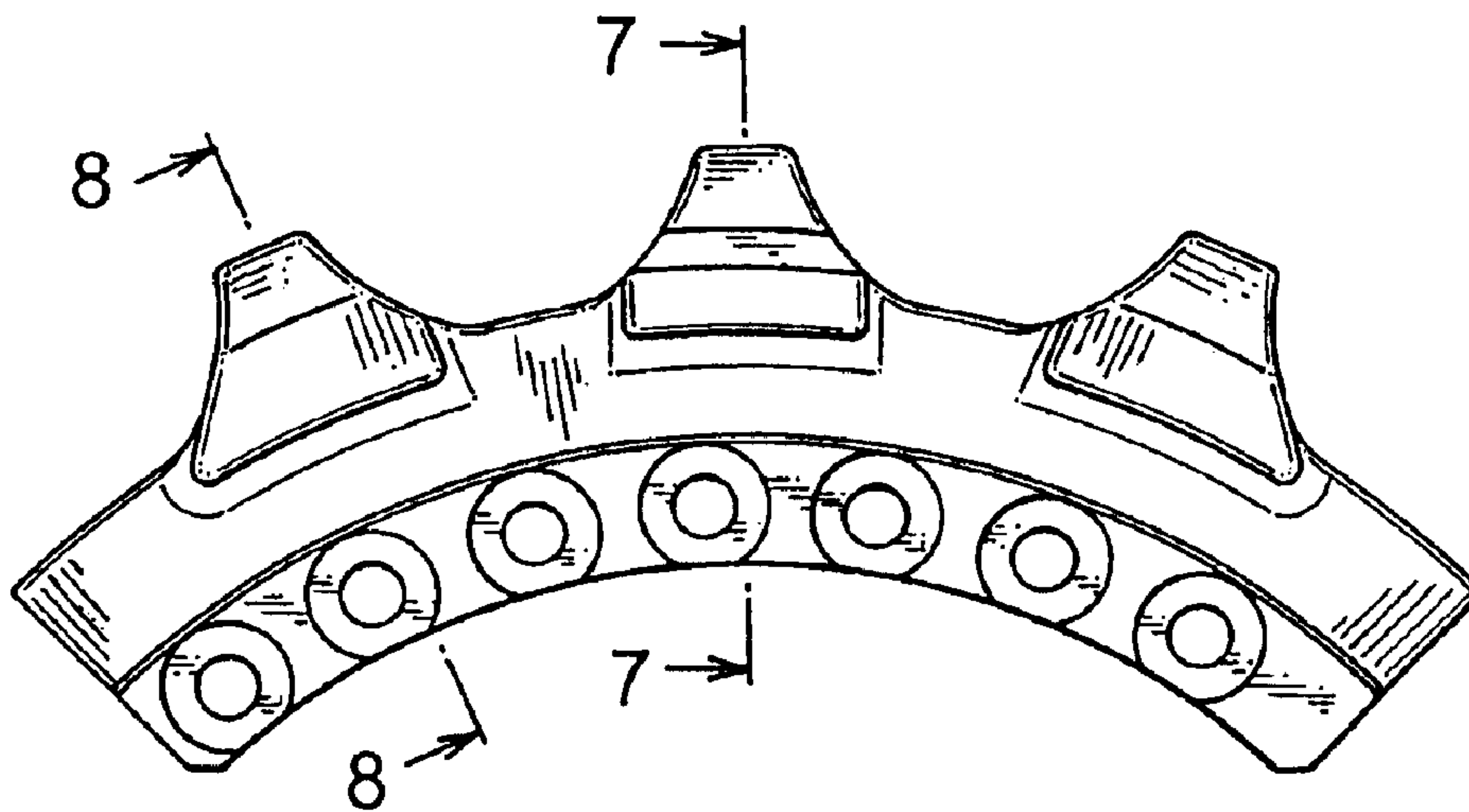

Fig. 3

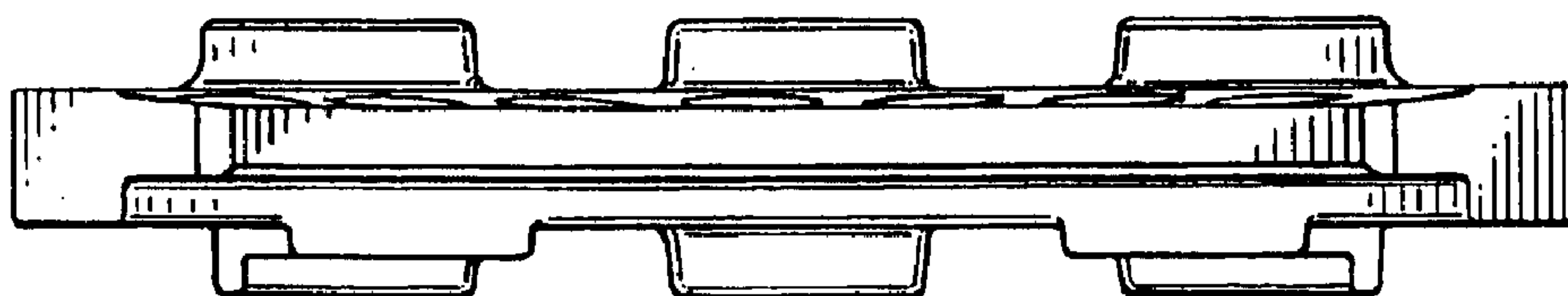

Fig. 4

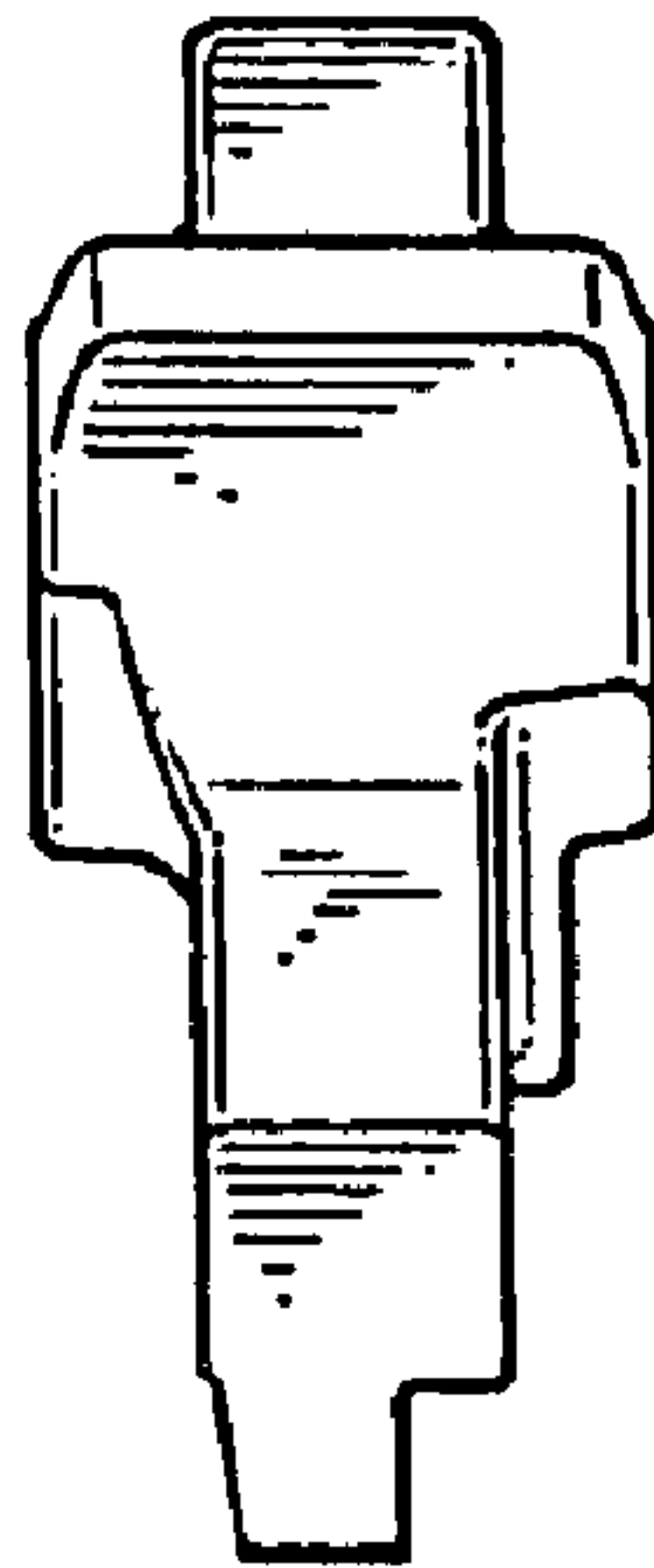

Fig. 5

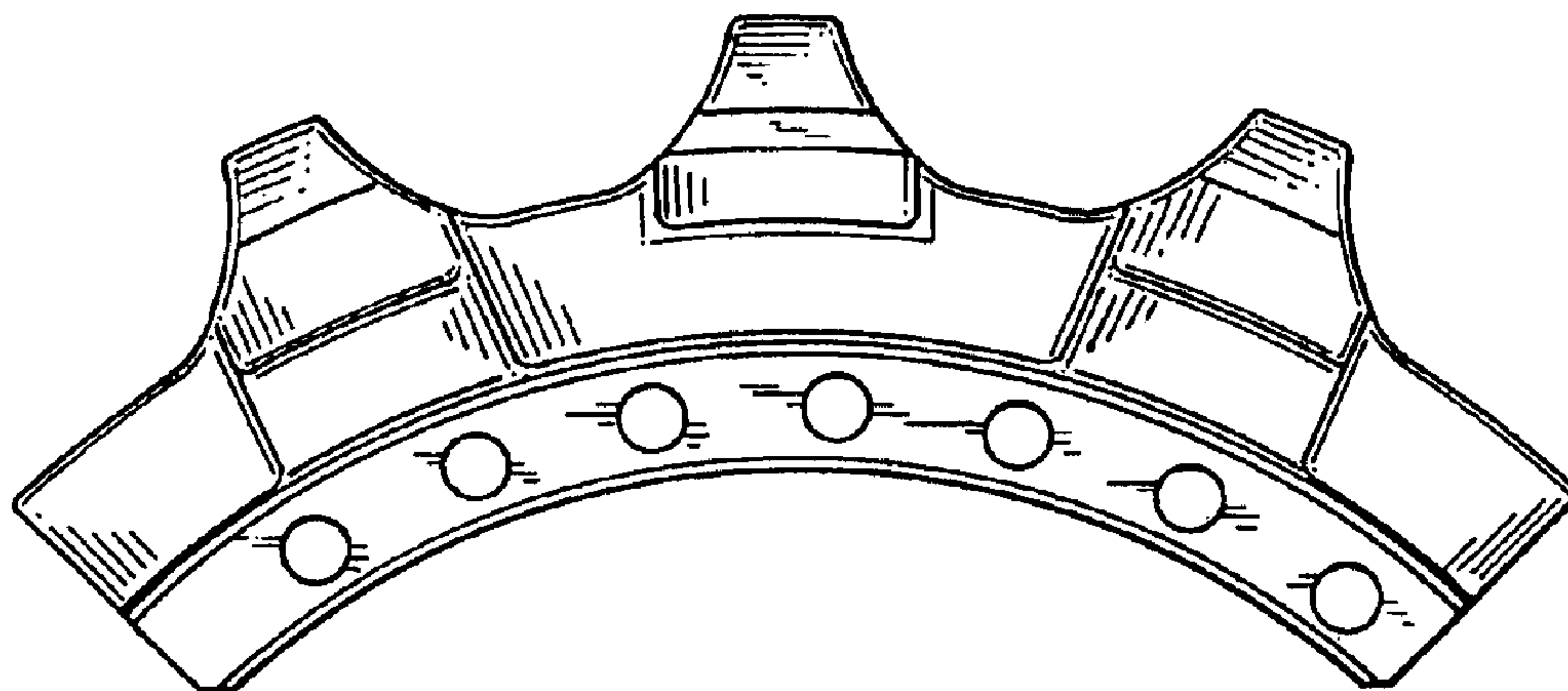

Fig. 6

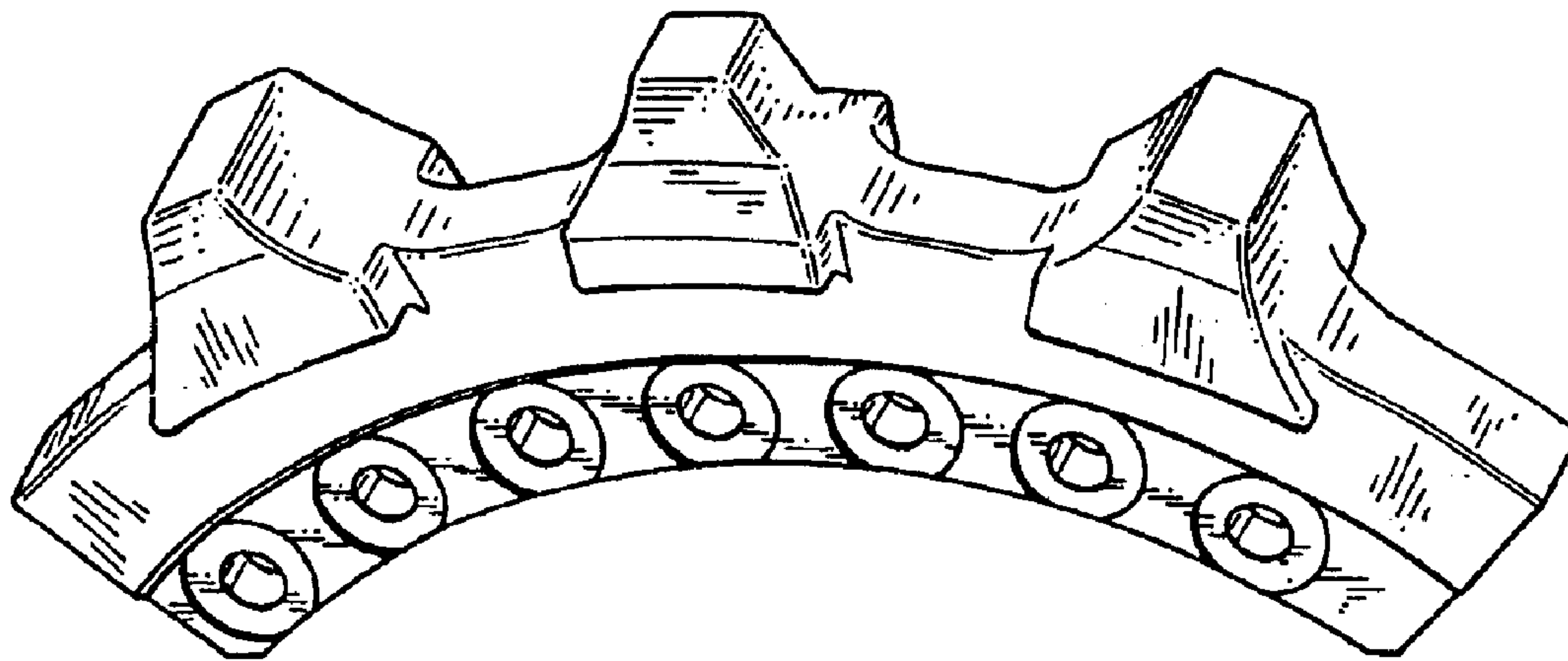

Fig. 7

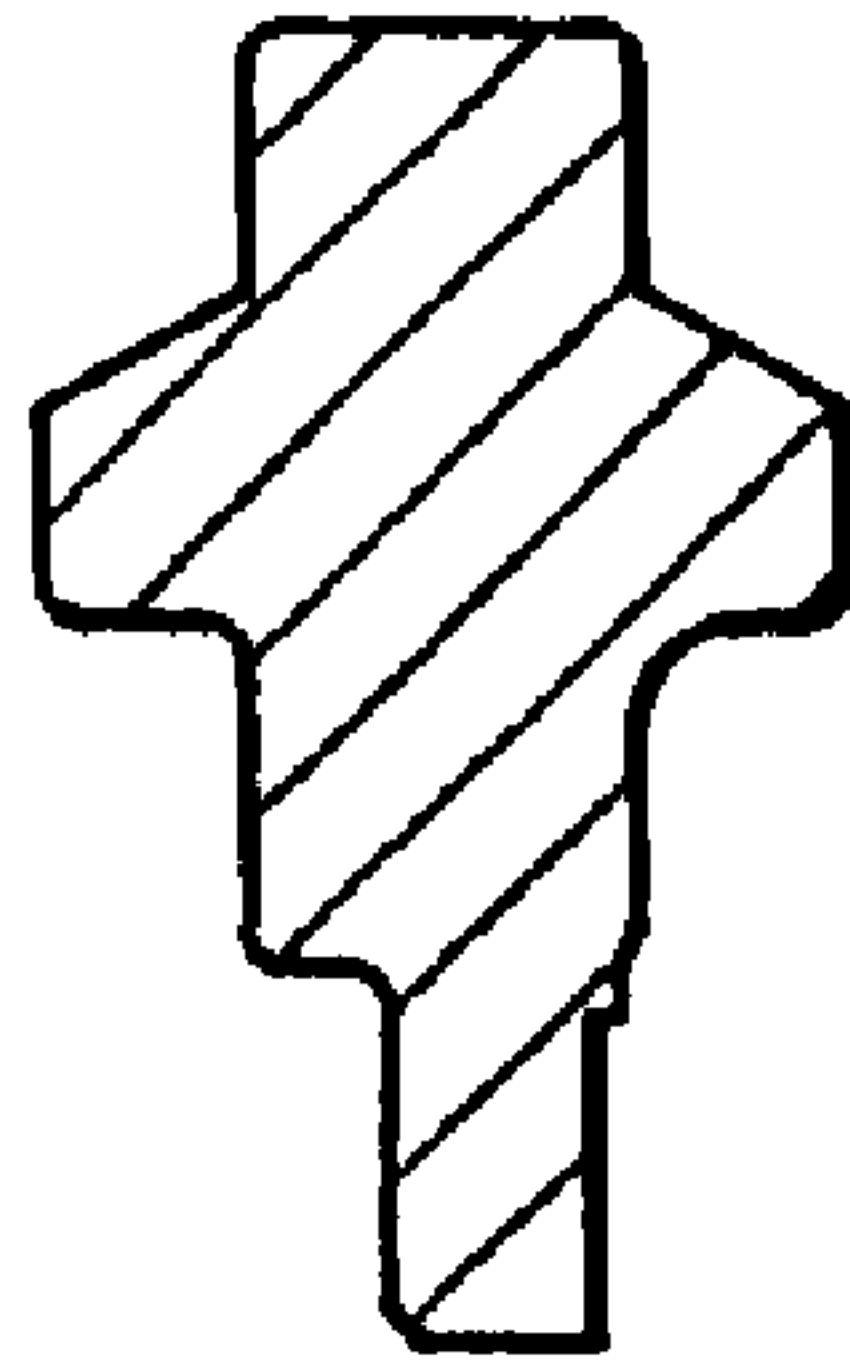

Fig. 8

