



US00D510360S

(12) **United States Design Patent**
Ishigami et al.

(10) **Patent No.: US D510,360 S**

(45) **Date of Patent: ** Oct. 4, 2005**

(54) **FACSIMILE MACHINE**

(75) **Inventors: Michifumi Ishigami, Nagoya (JP);
Kazuhiro Hoshiya, Nagoya (JP);
Yasutake Yamaguchi, Chiryu (JP)**

(73) **Assignee: Brother Industries, Limited, Nagoya (JP)**

(**) **Term: 14 Years**

(21) **Appl. No.: 29/210,565**

(22) **Filed: Aug. 4, 2004**

(30) **Foreign Application Priority Data**

Mar. 30, 2004 (JP) 2004-009796

(51) **LOC (8) Cl. 16-02**

(52) **U.S. Cl. D14/468**

(58) **Field of Search D14/466-471,
D14/462; 358/400, 401, 501-506; D18/36,
37**

(56) **References Cited**

U.S. PATENT DOCUMENTS

- 4,872,061 A * 10/1989 Uchiyama 358/400
- 4,914,281 A * 4/1990 Benton et al. 235/492
- D315,151 S * 3/1991 Tamano et al. D14/468
- D323,159 S * 1/1992 Iwasaki et al. D14/468
- 5,172,243 A * 12/1992 Hayashi et al. 358/400

- 5,183,431 A * 2/1993 Todokoro 446/142
- D355,179 S * 2/1995 Sawada et al. D14/468
- D365,343 S * 12/1995 Omino D14/468
- D386,490 S * 11/1997 Fujimoto D14/468
- D493,469 S * 7/2004 Hattori et al. D14/468

* cited by examiner

Primary Examiner—Prabhakar Deshmukh

(74) *Attorney, Agent, or Firm*—Oliff & Berridge, PLC

(57) **CLAIM**

The ornamental design for a facsimile machine, as shown and described.

DESCRIPTION

FIG. 1 is a perspective view of a facsimile machine;
 FIG. 2 is a front view thereof;
 FIG. 3 is a top view thereof;
 FIG. 4 is a rear view thereof;
 FIG. 5 is a bottom view thereof;
 FIG. 6 is a right-side view thereof;
 FIG. 7 is a left-side view thereof;
 FIG. 8 is a perspective view thereof with a handset removed;
 FIG. 9 is a perspective view thereof with a cover in an open position; and,
 FIG. 10 is a perspective view thereof with a paper discharge tray in a closed position.

The broken lines are for illustrative purposes only and form no part of the claimed design.

1 Claim, 7 Drawing Sheets

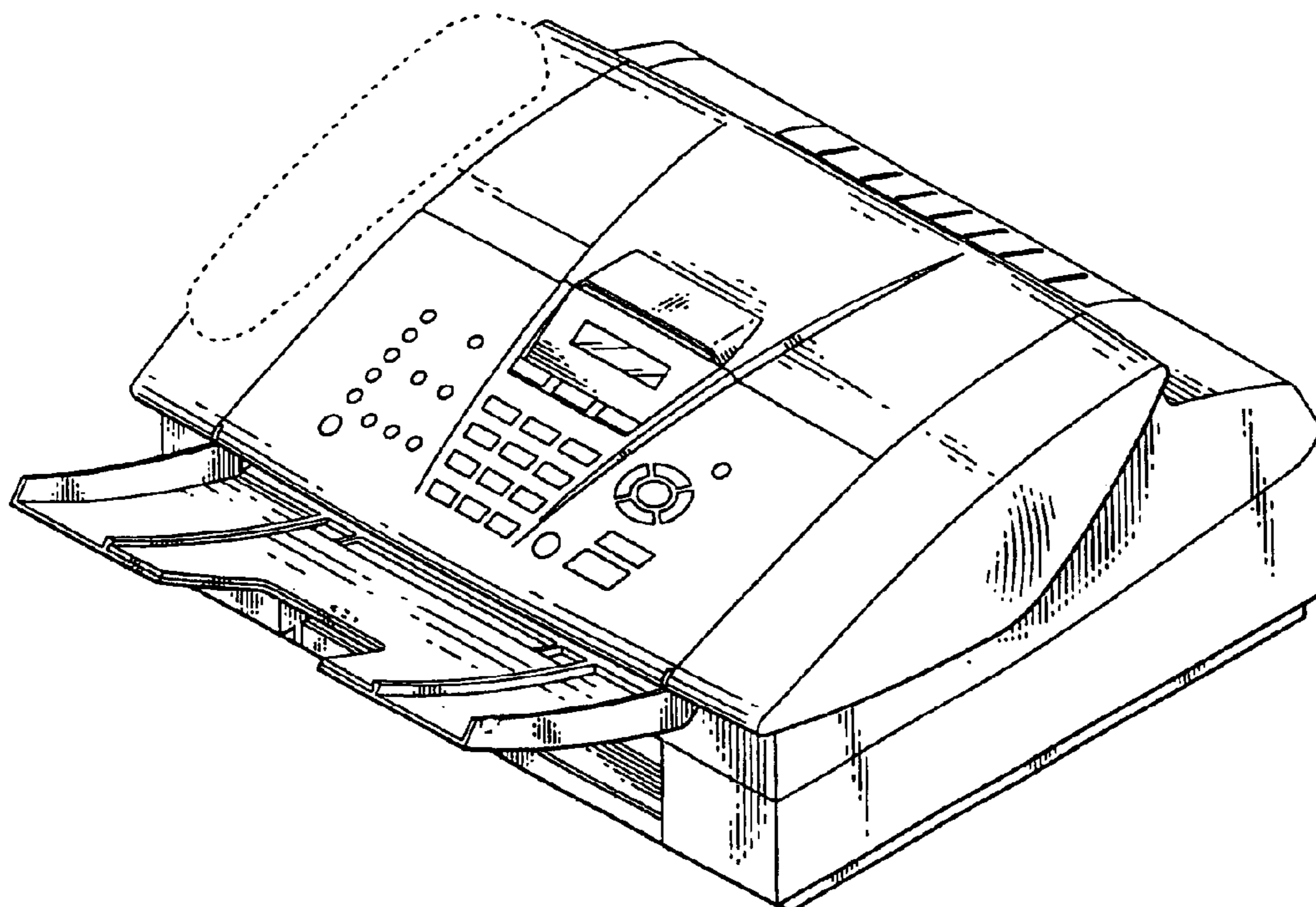

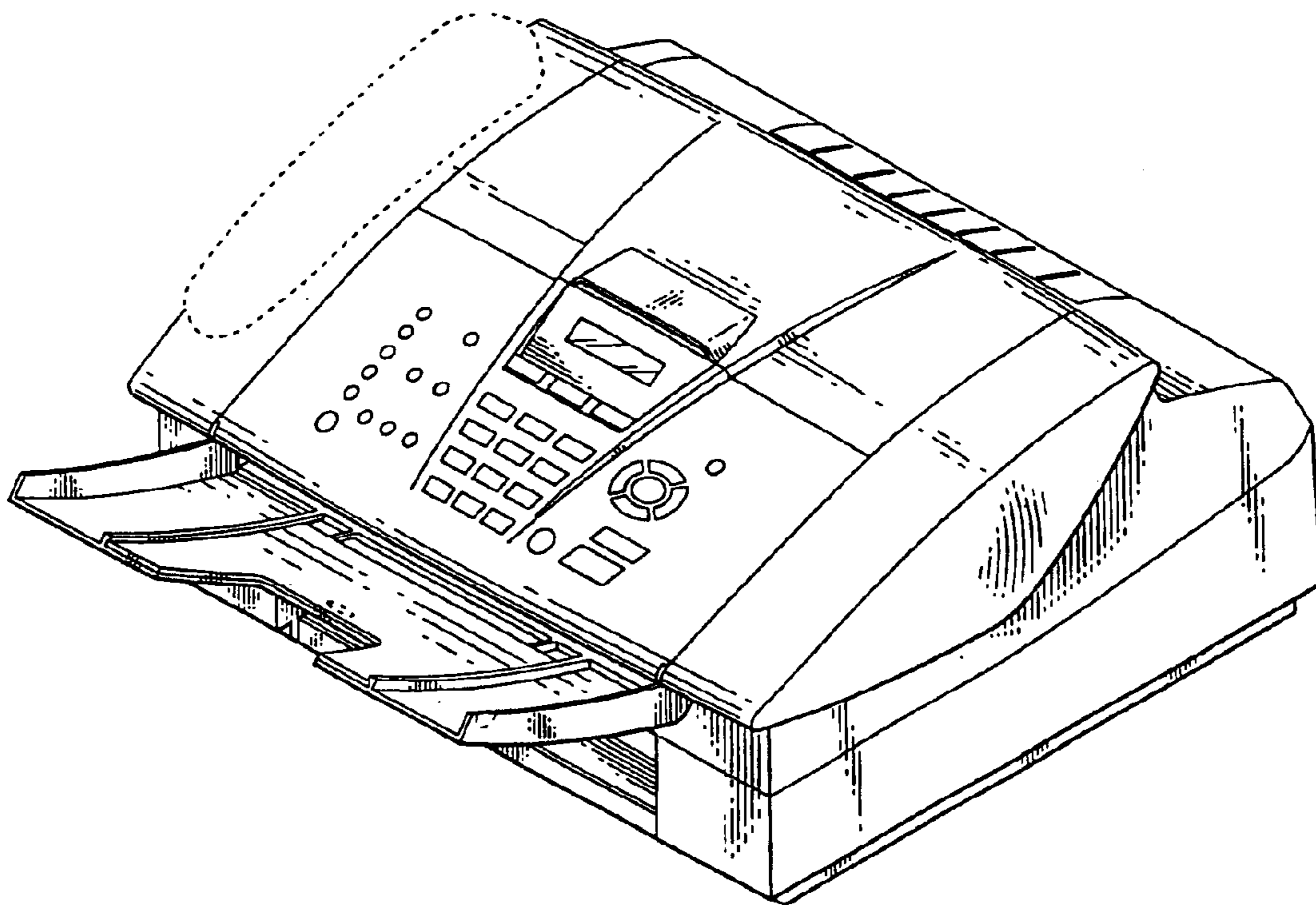

Fig. 1

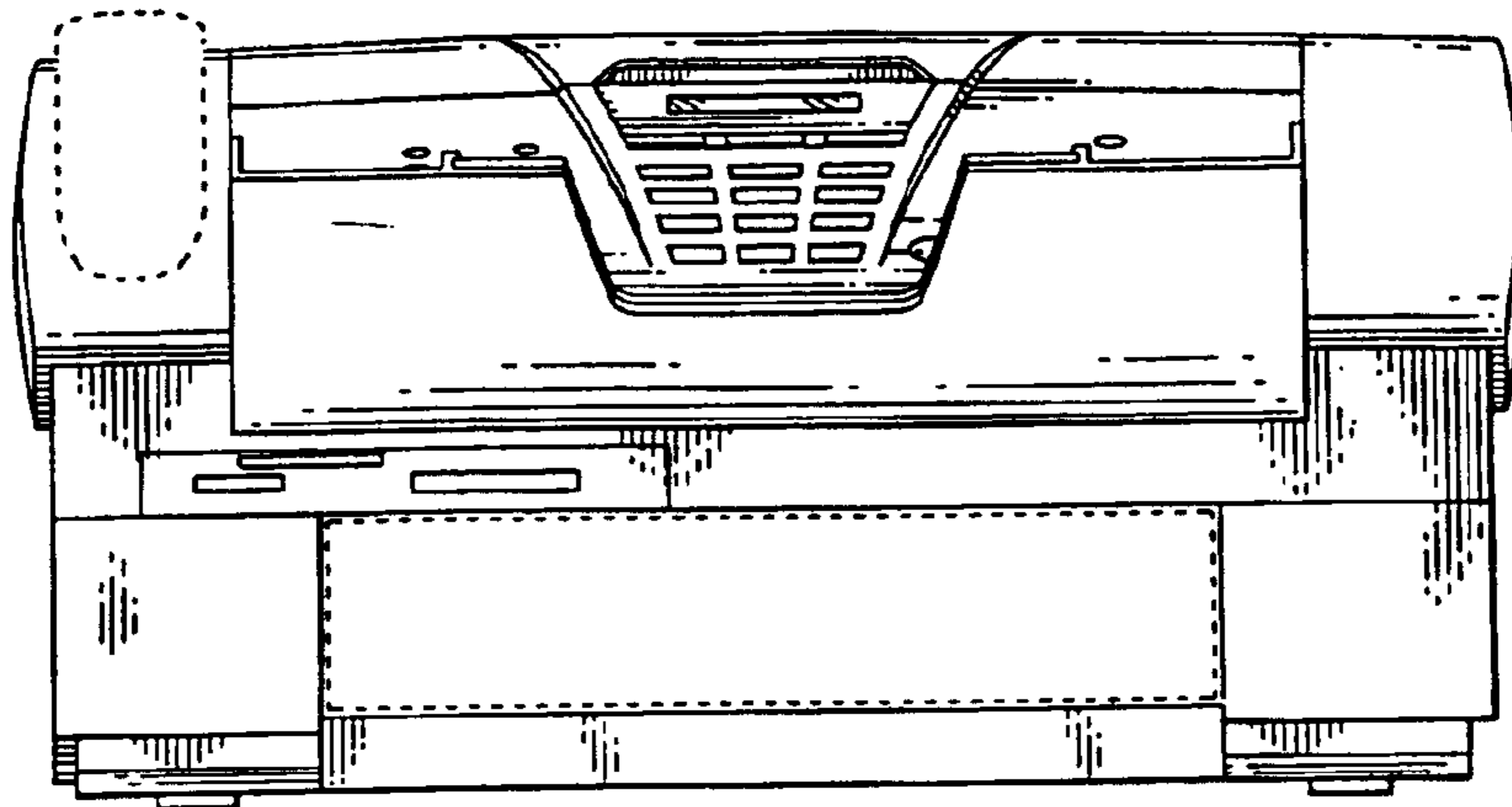

Fig. 2

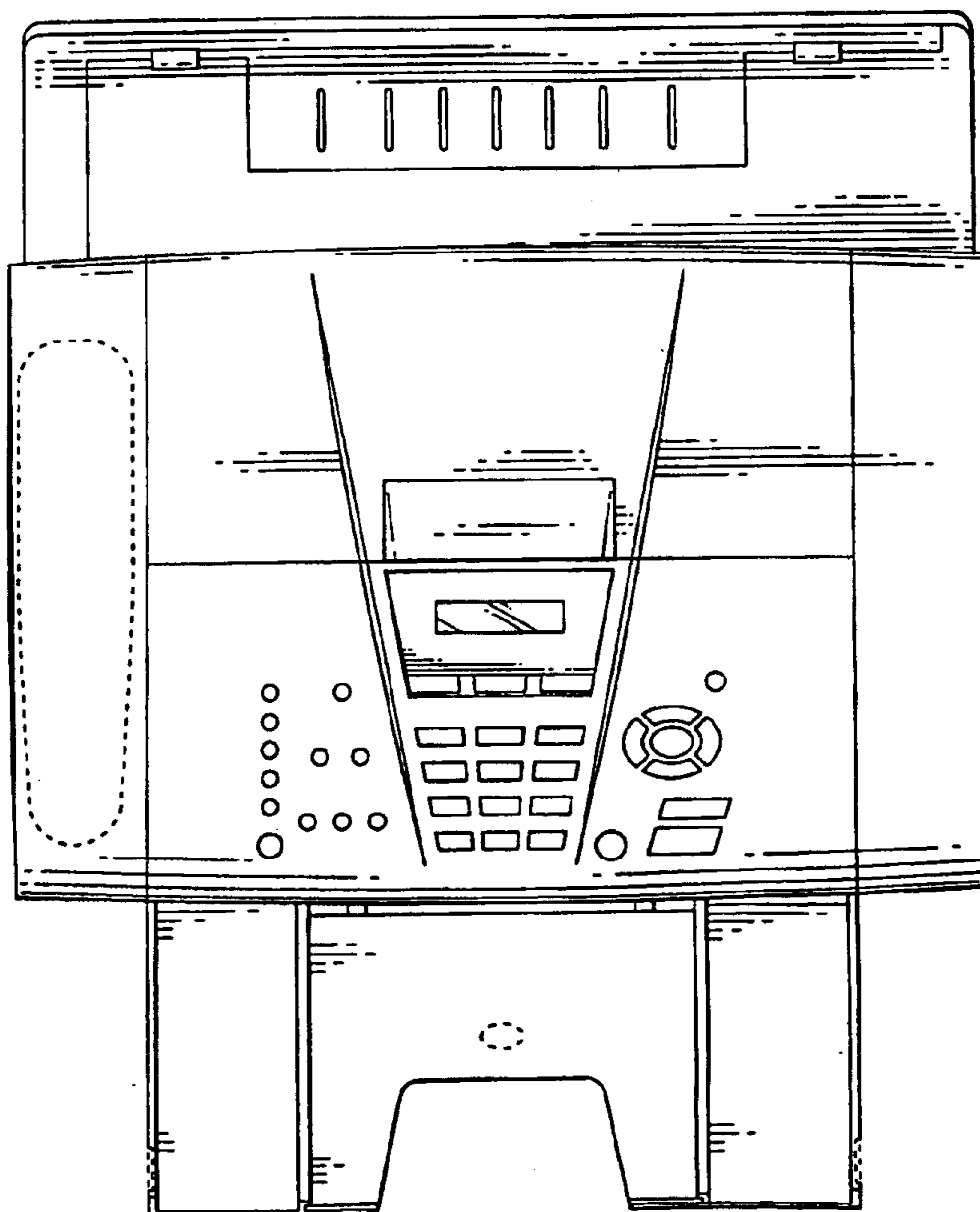

Fig. 3

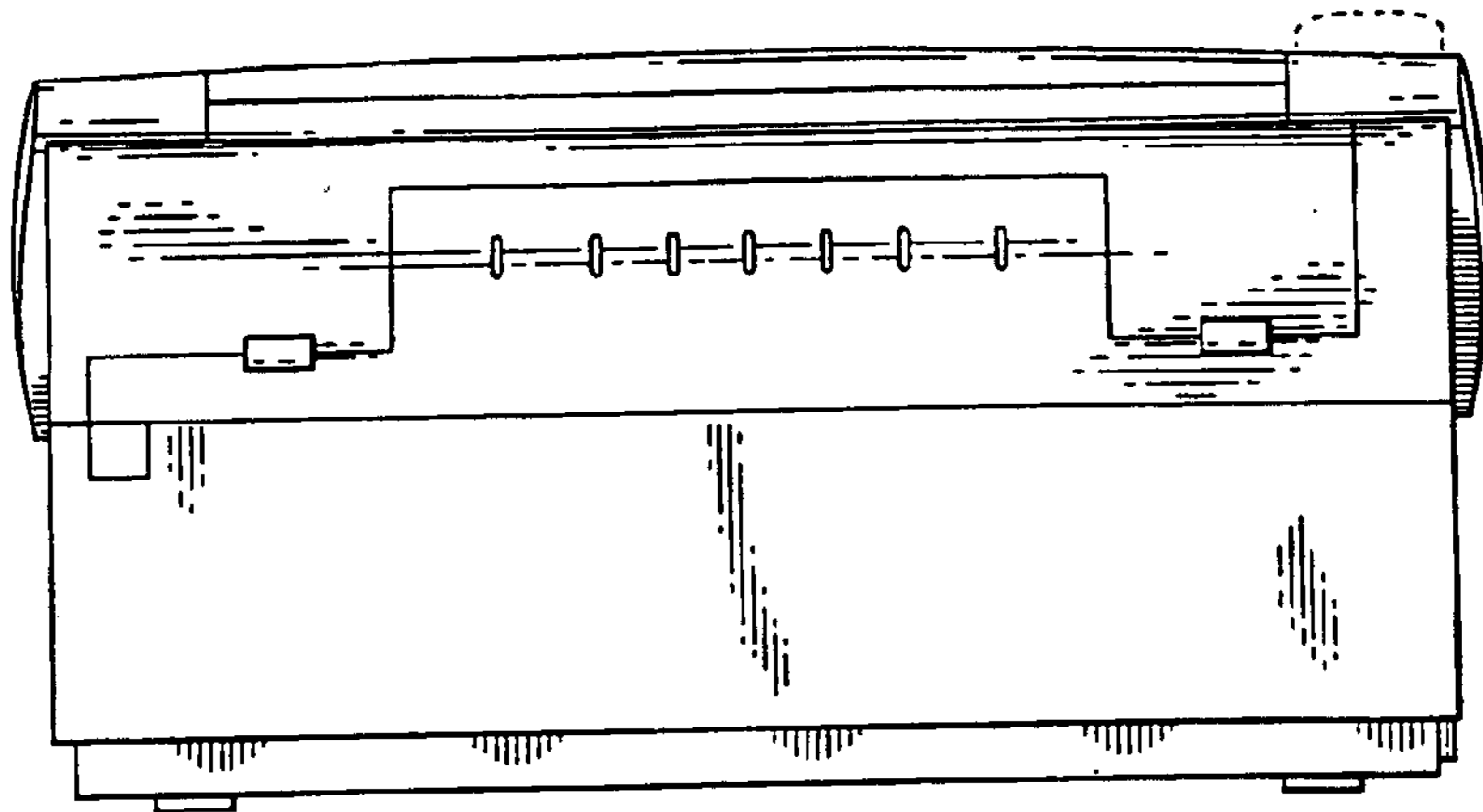

Fig. 4

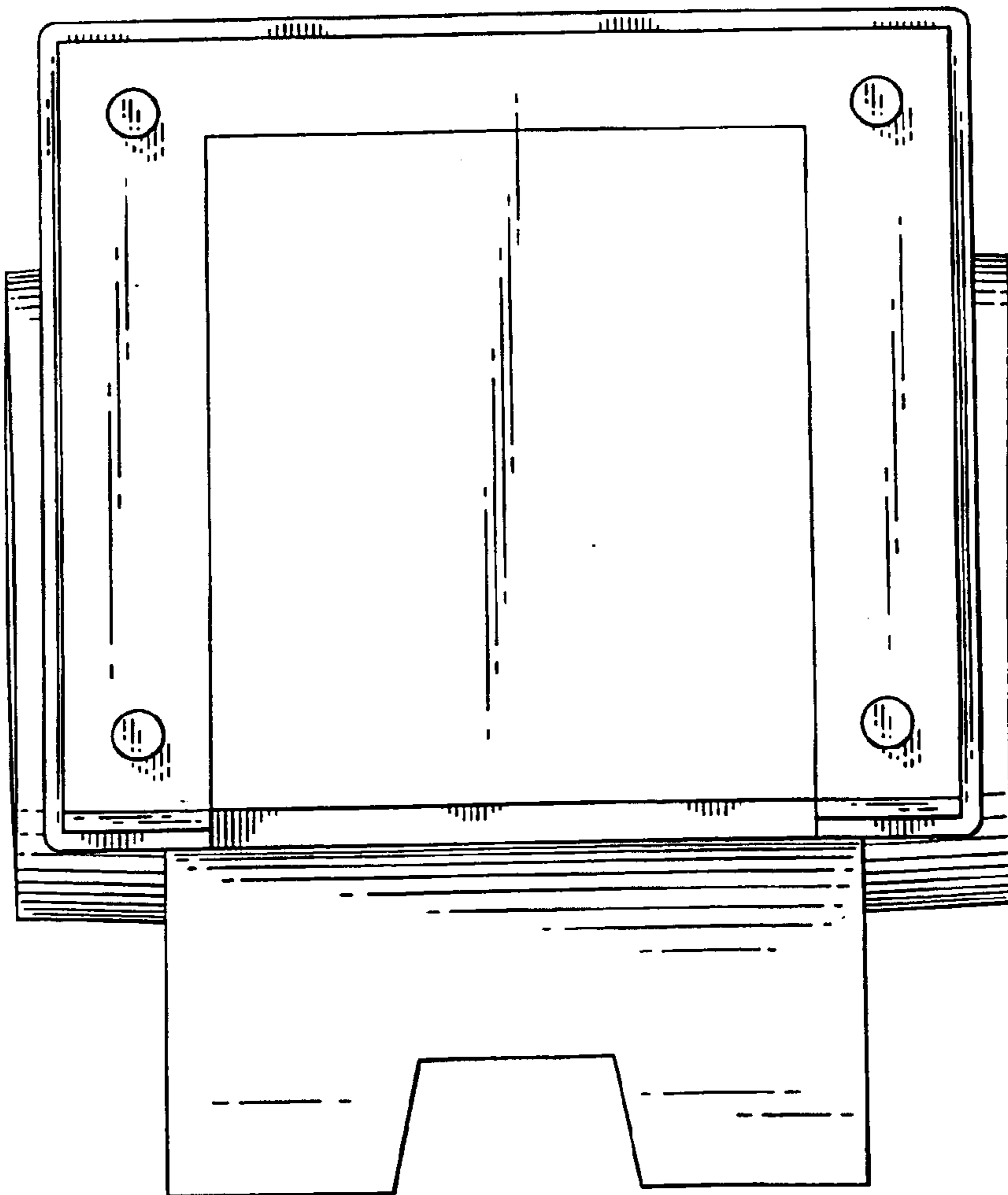

Fig. 5

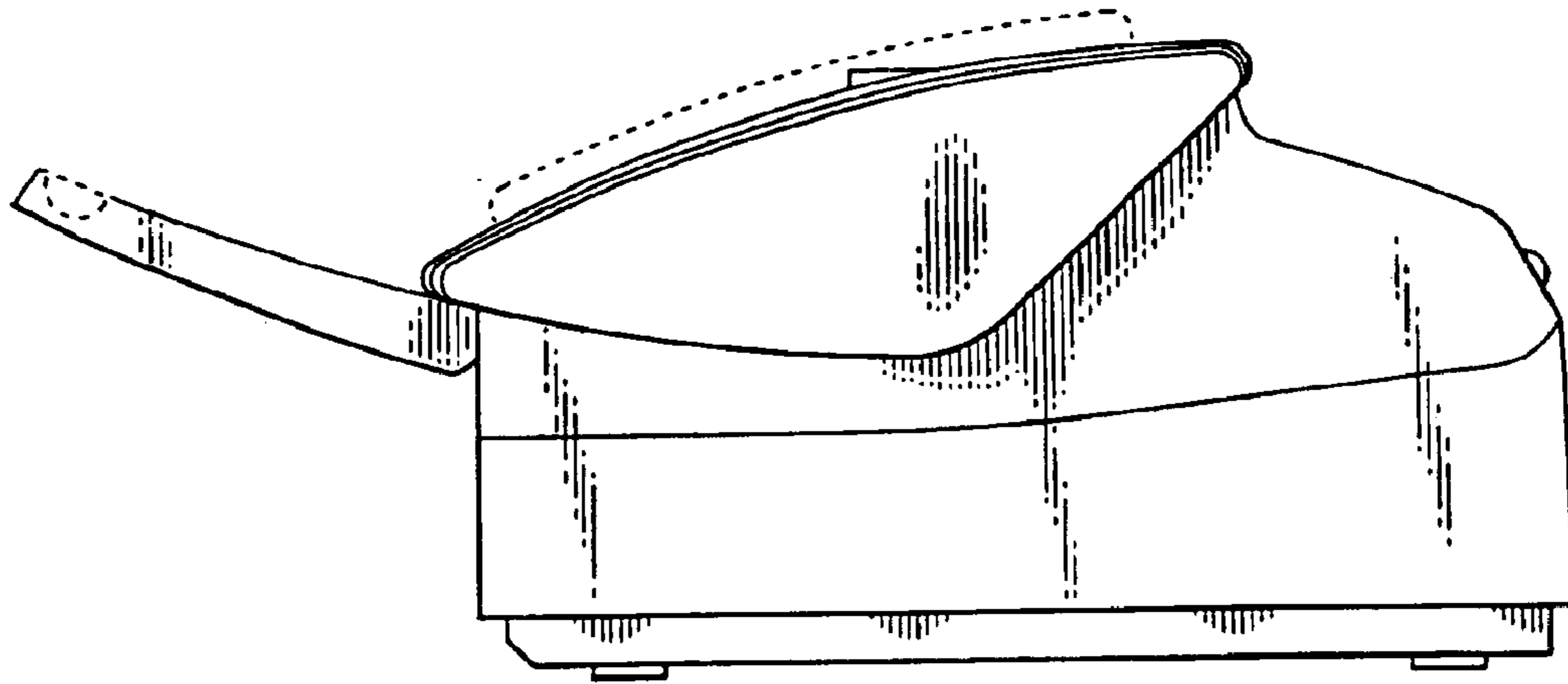

Fig. 6

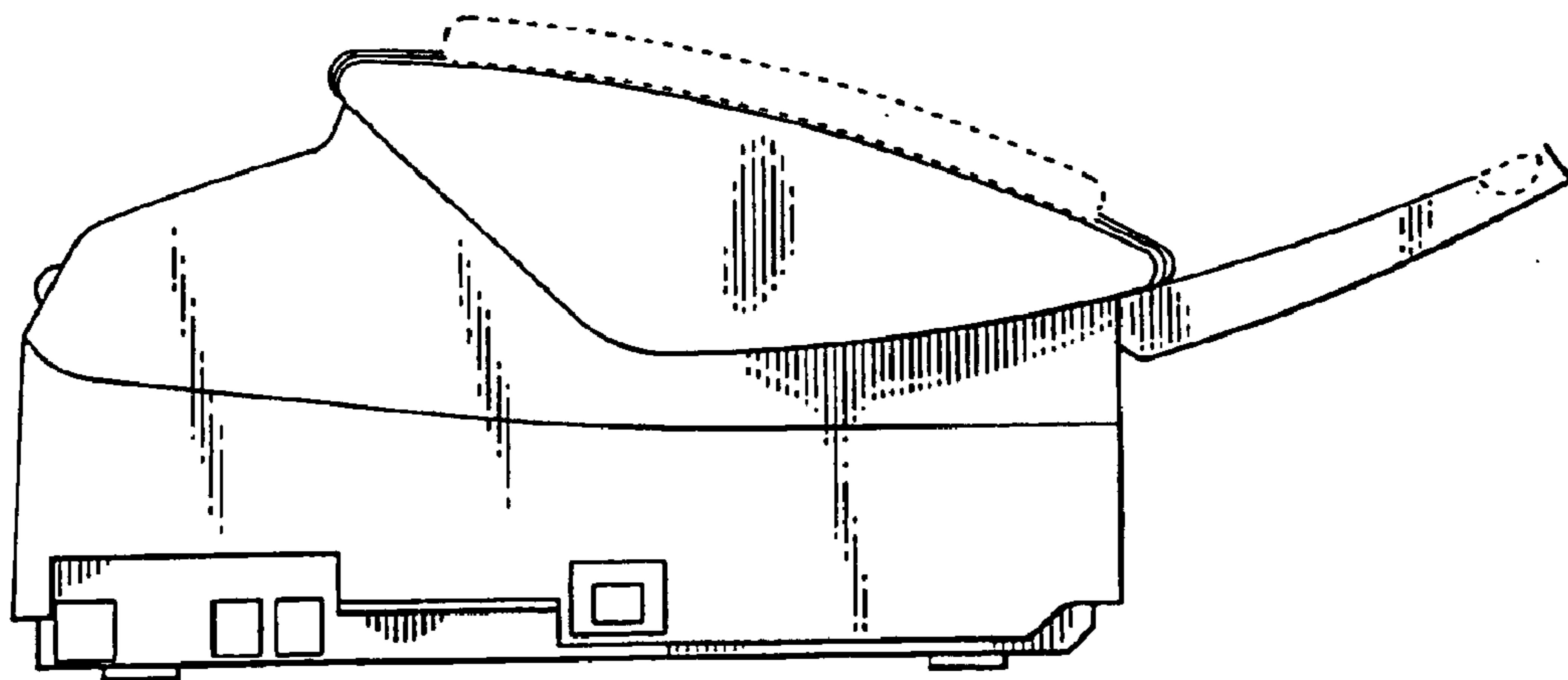

Fig. 7

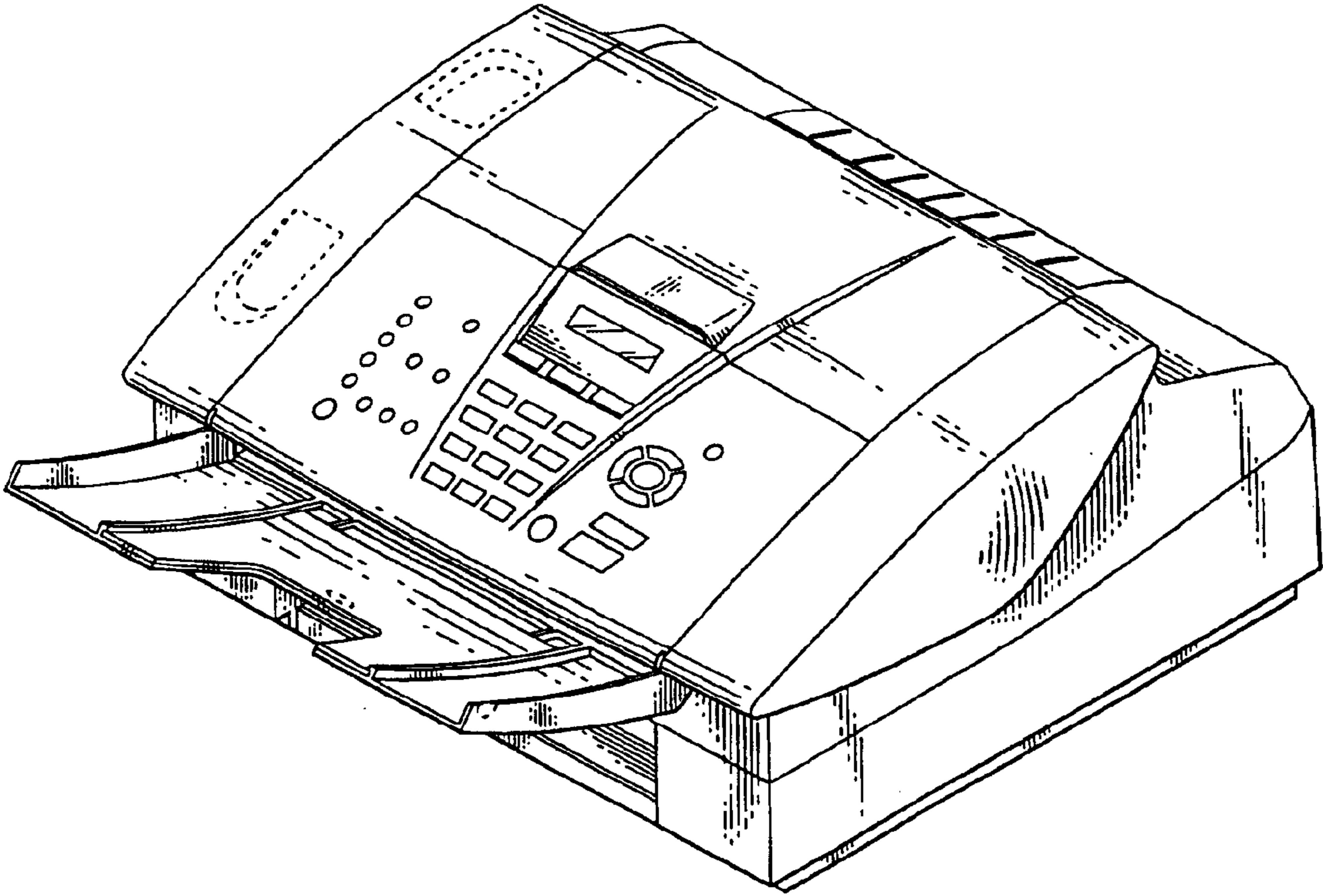

Fig. 8

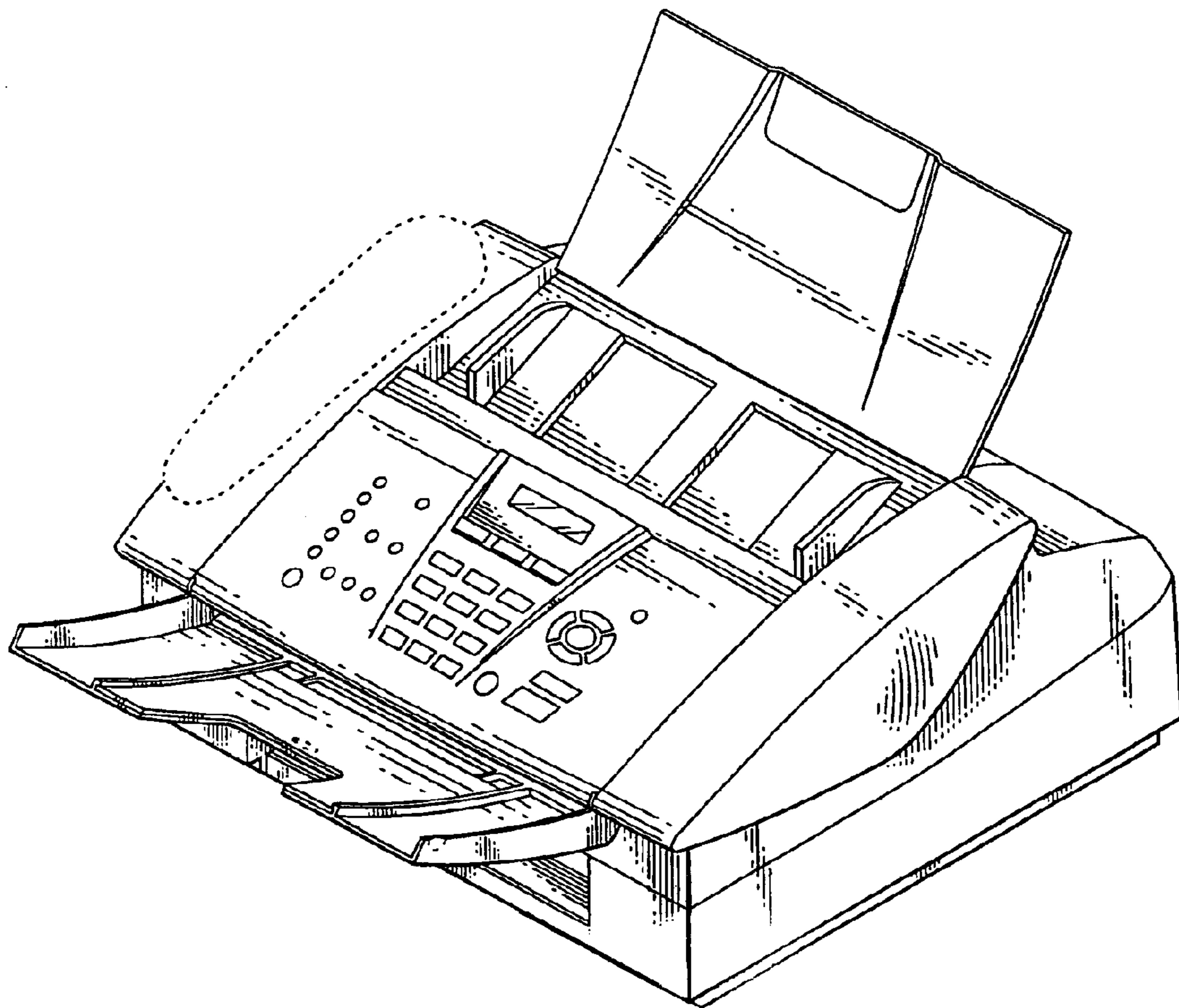

Fig. 9

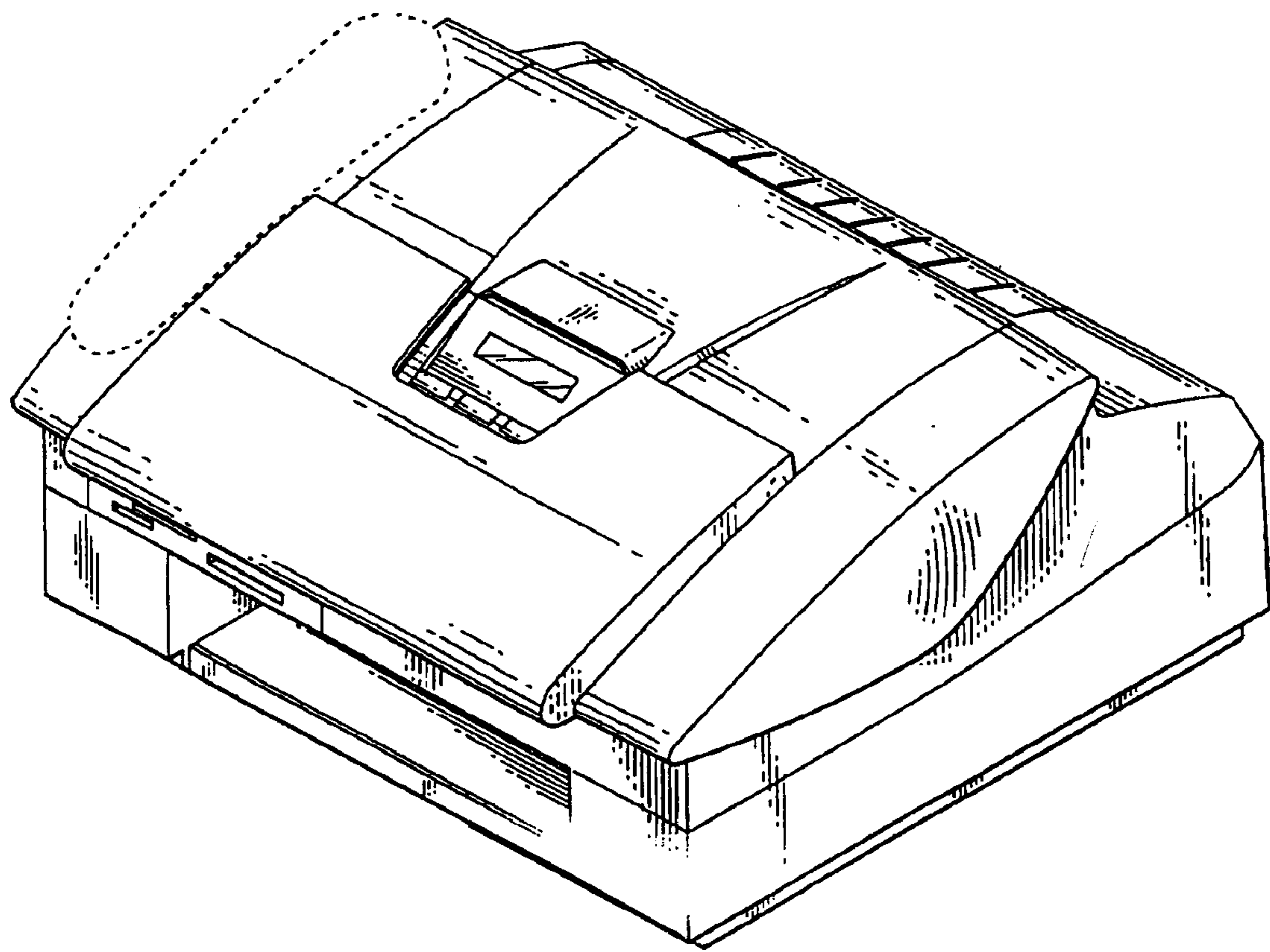

Fig. 10