



US00D510338S

(12) **United States Design Patent** (10) **Patent No.:** **US D510,338 S**
Brimhall et al. (45) **Date of Patent:** **** Oct. 4, 2005**

(54) **SPEAKER CONTROLLER**

D390,565 S * 2/1998 Cheng D14/214
 D448,752 S * 10/2001 Matsuoka D14/214
 D467,989 S * 12/2002 Belland D22/144
 D489,055 S * 4/2004 Yamada D14/215

(75) Inventors: **Wells Brimhall**, Portland, OR (US);
Raymond Weikel, Camas, WA (US);
Alexander S. Danielson, Forest Grove,
 OR (US); **Omer Kotzer**, Portland, OR
 (US); **Alf U. Hackenberg**, Munich
 (DE); **Martin Langkau**, Munich (DE);
Andreas Schuessler, Munich (DE)

* cited by examiner

Primary Examiner—Nanda Bondade
 (74) *Attorney, Agent, or Firm*—Ipsolon LLP

(73) Assignee: **Logitech Europe S.A.**,
 Romanel-sur-Morgas (CH)

(57) **CLAIM**

We claim the ornamental design for a speaker controller, as shown and described.

(**) Term: **14 Years**

DESCRIPTION

(21) Appl. No.: **29/205,936**

FIG. 1 is a front, right perspective view of the speaker controller;

(22) Filed: **May 21, 2004**

FIG. 2 is a rear, right perspective view thereof;

(51) **LOC (8) Cl.** **14-01**

FIG. 3 is a rear elevation view thereof;

(52) **U.S. Cl.** **D14/214**

FIG. 4 is a top plan view thereof;

(58) **Field of Search** D14/204, 207,
 D14/209–216, 356; 181/143–144, 147–148,
 150, 157, 198–199, 151, 153, 300–302,
 306, 333, 345, 361–364, 386–388, 332,
 336

FIG. 5 is a left, elevation view thereof;

FIG. 6 is a front, elevation view thereof;

FIG. 7 is a right, elevation view thereof; and,

FIG. 8 is a bottom plan view thereof.

The broken lines showing exemplar control buttons, a stand, feet, seams, vents, and input/output connectors are for illustrative purpose only and form no part of the claimed design.

(56) **References Cited**

U.S. PATENT DOCUMENTS

D231,537 S * 4/1974 Kimbell D14/207

1 Claim, 2 Drawing Sheets

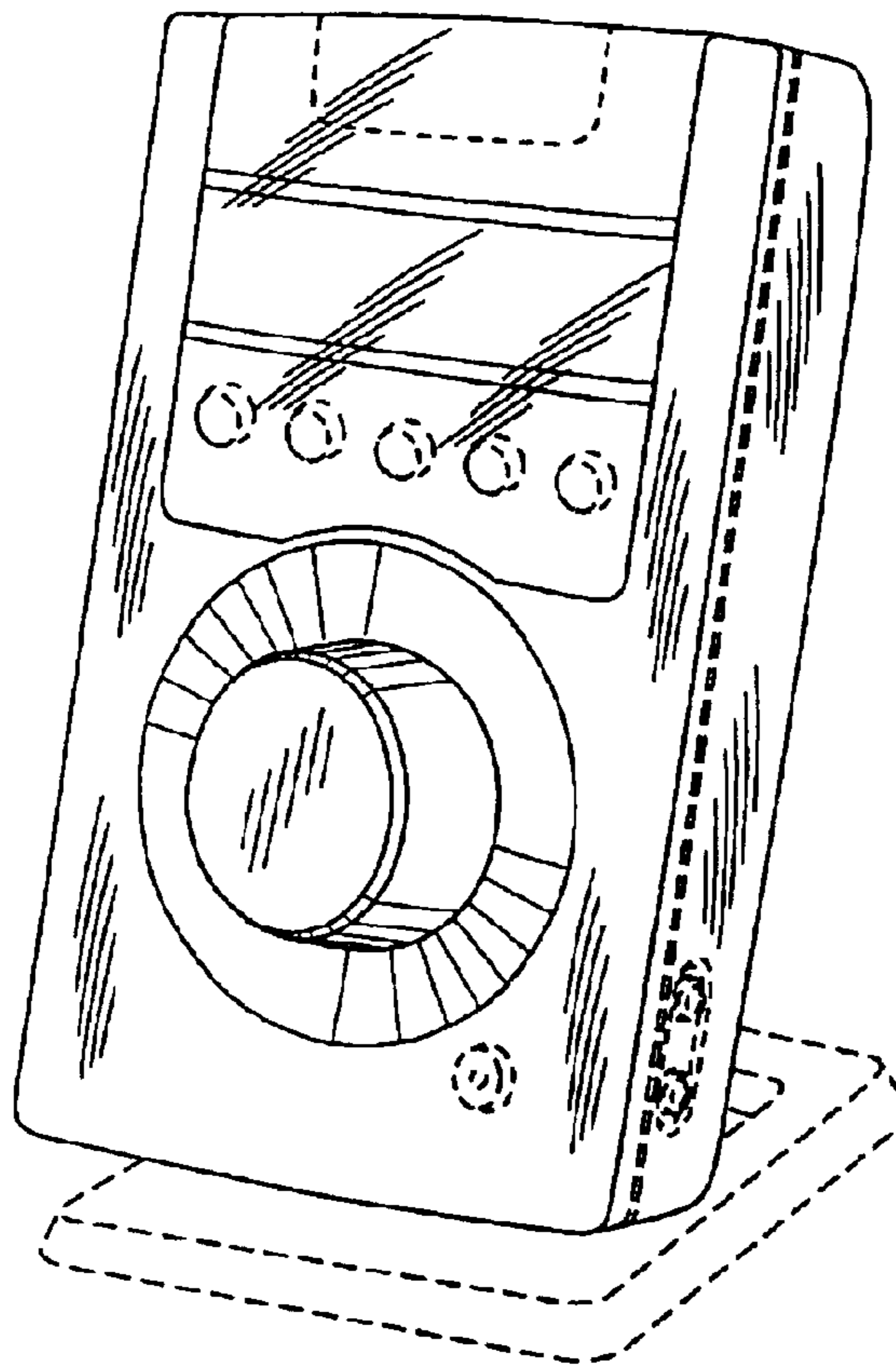

FIG. 1

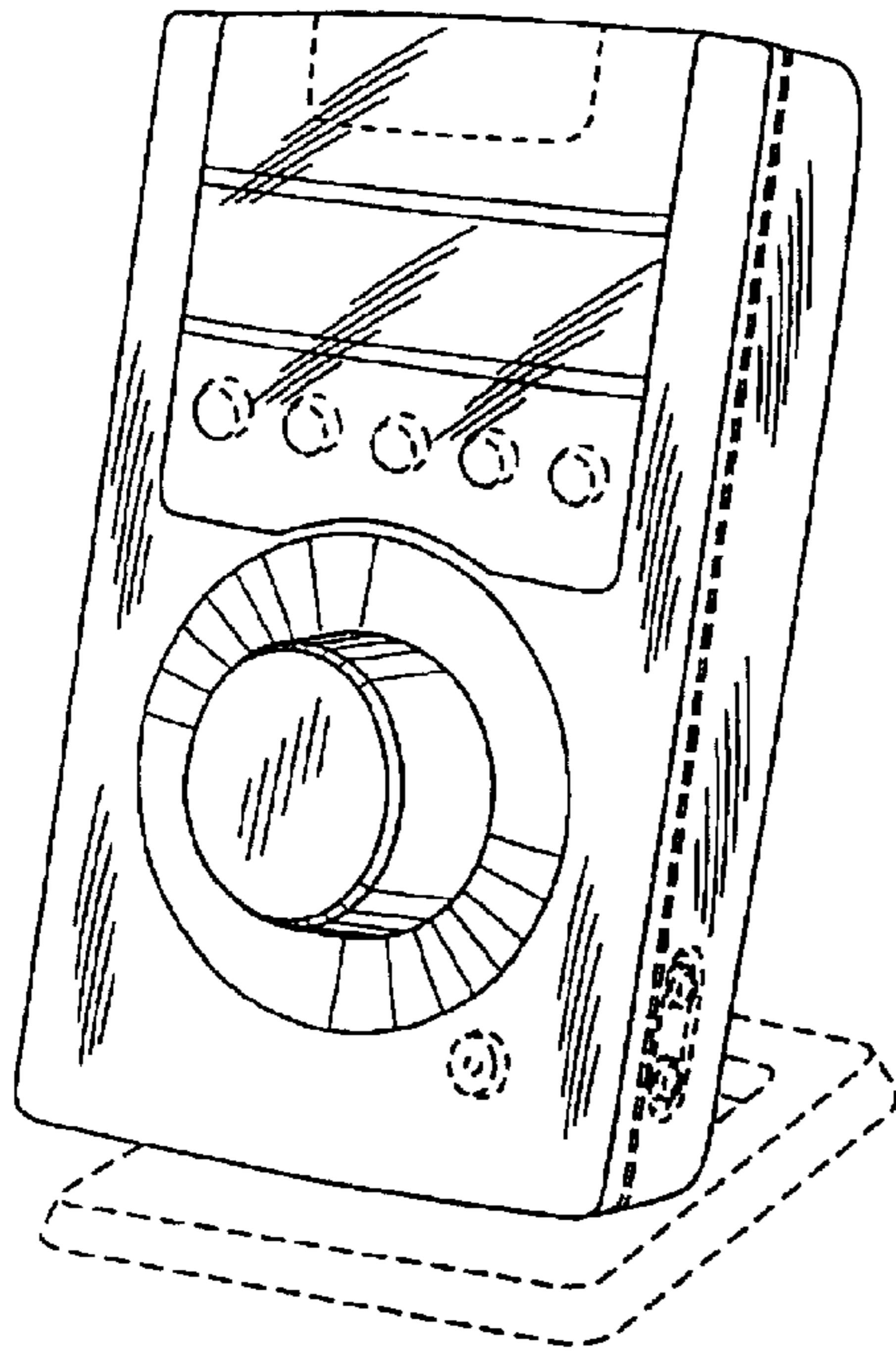

FIG. 2

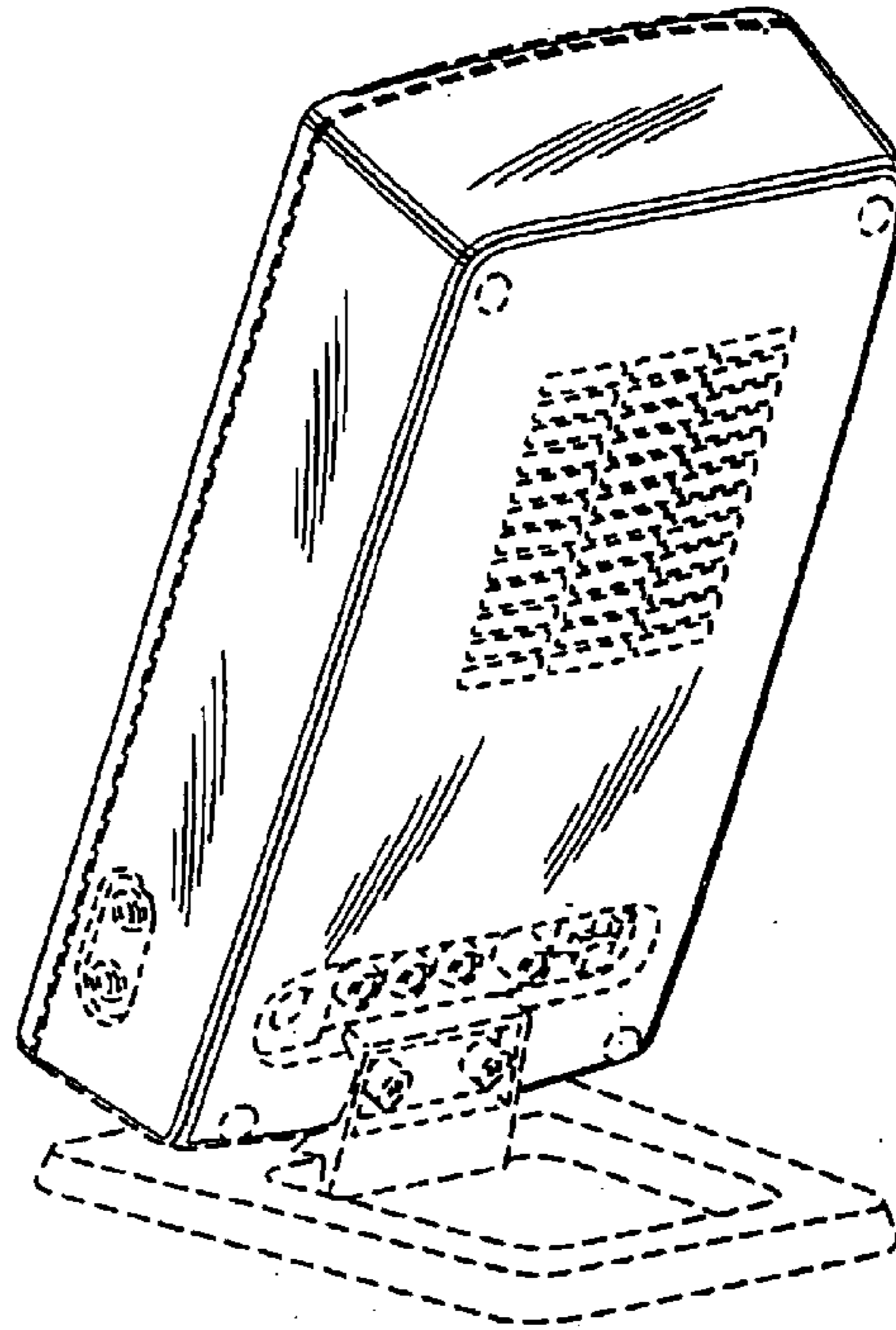

FIG. 3

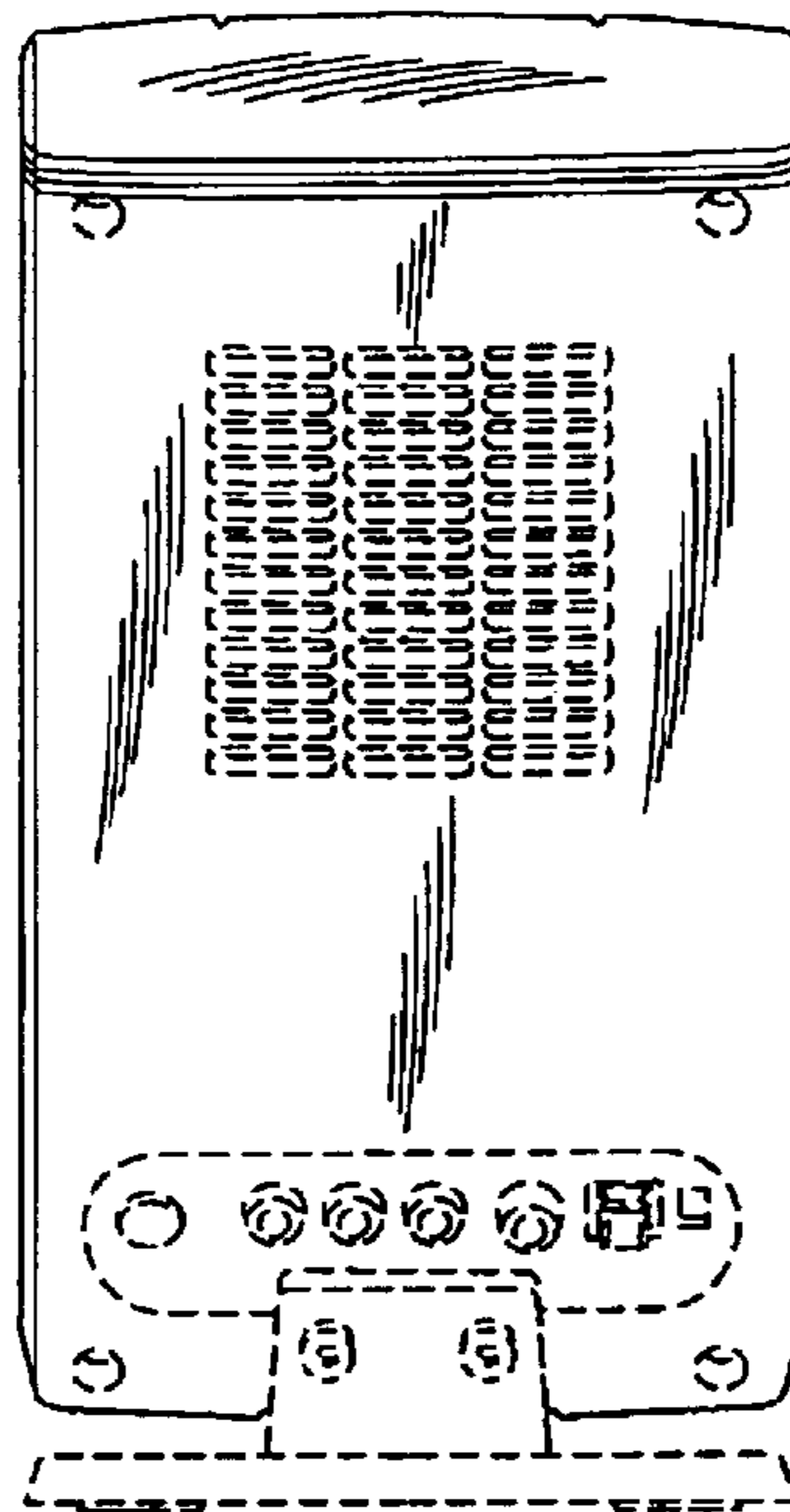

FIG. 4

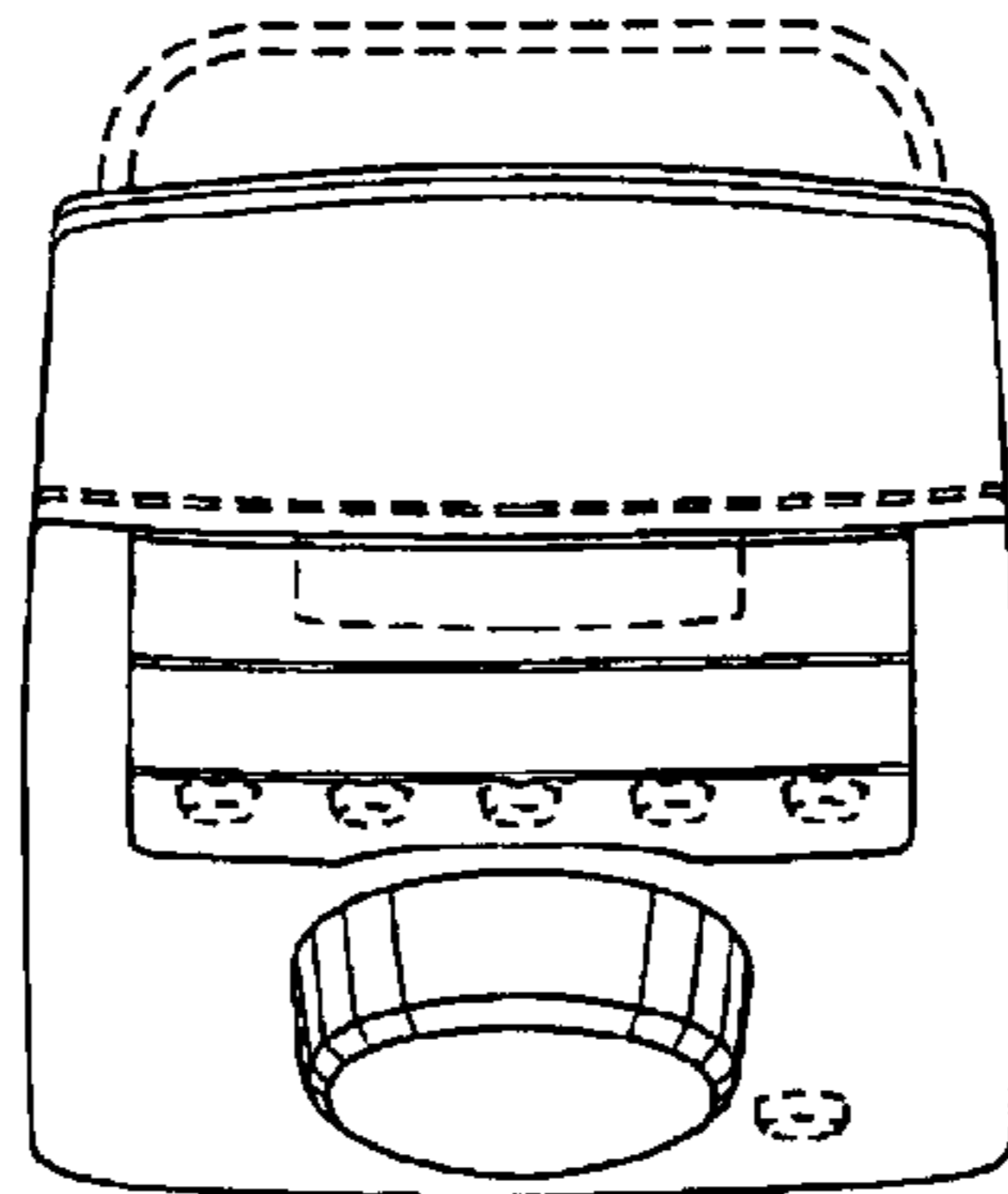

FIG. 5

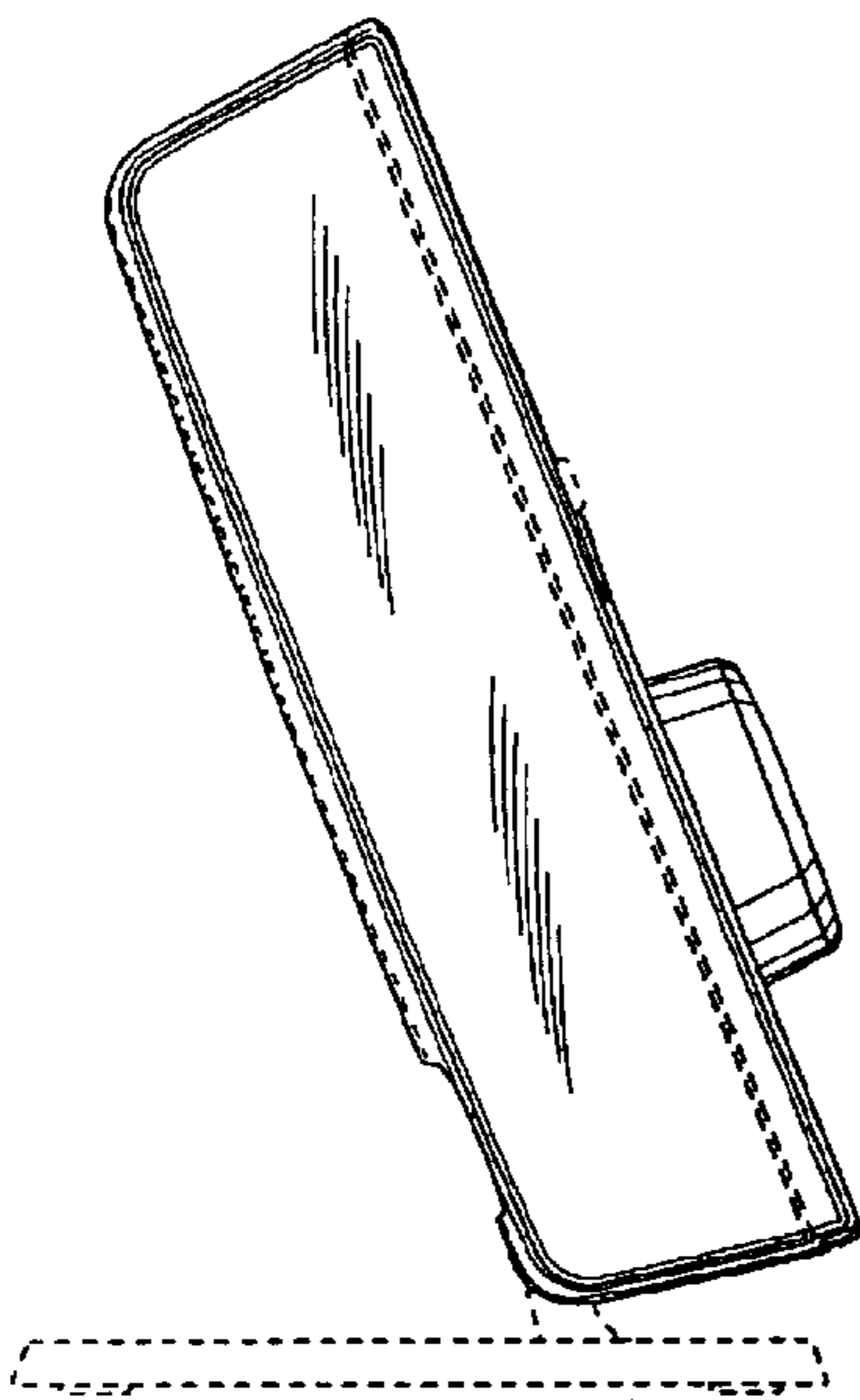

FIG. 6

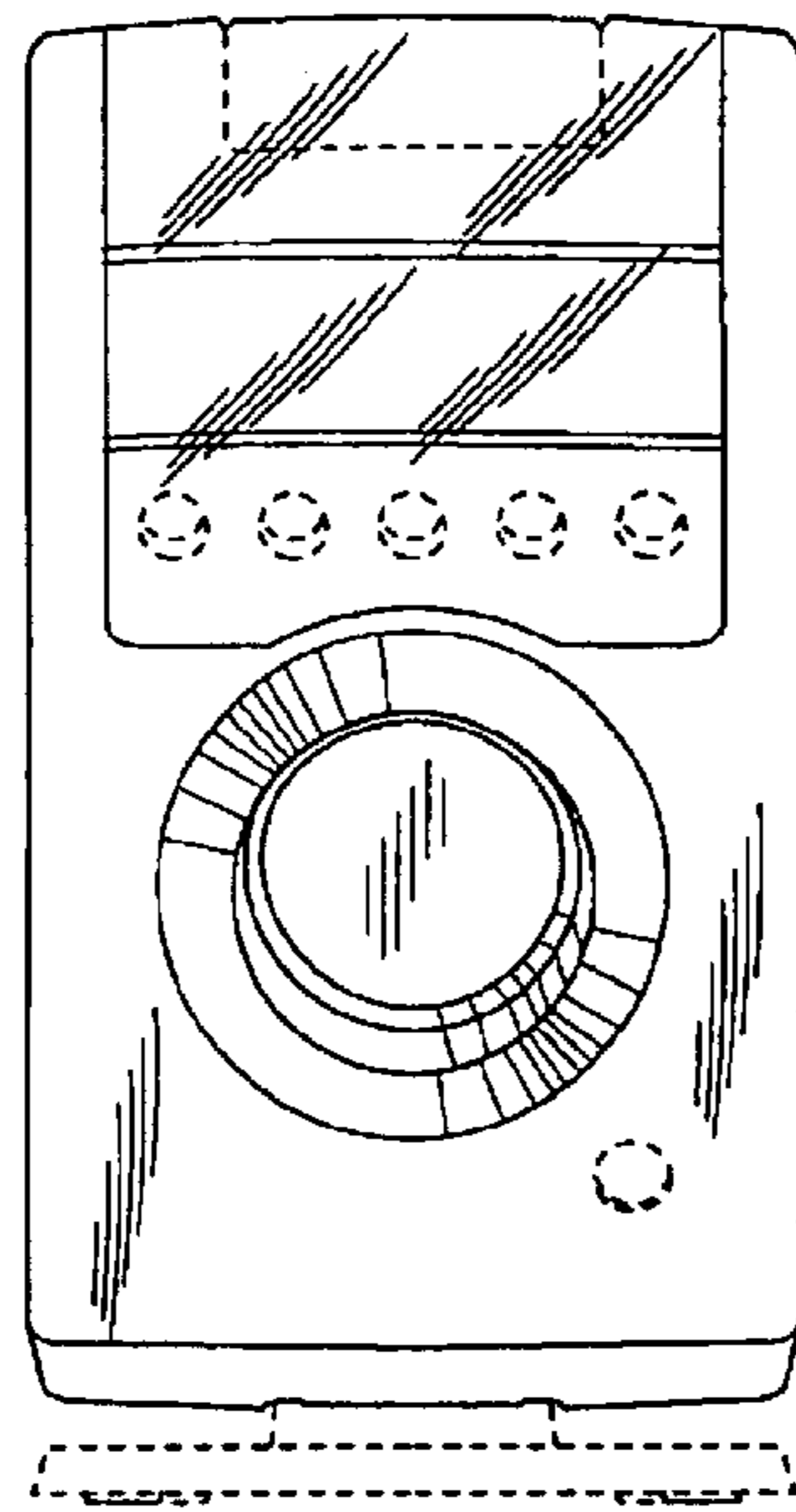

FIG. 7

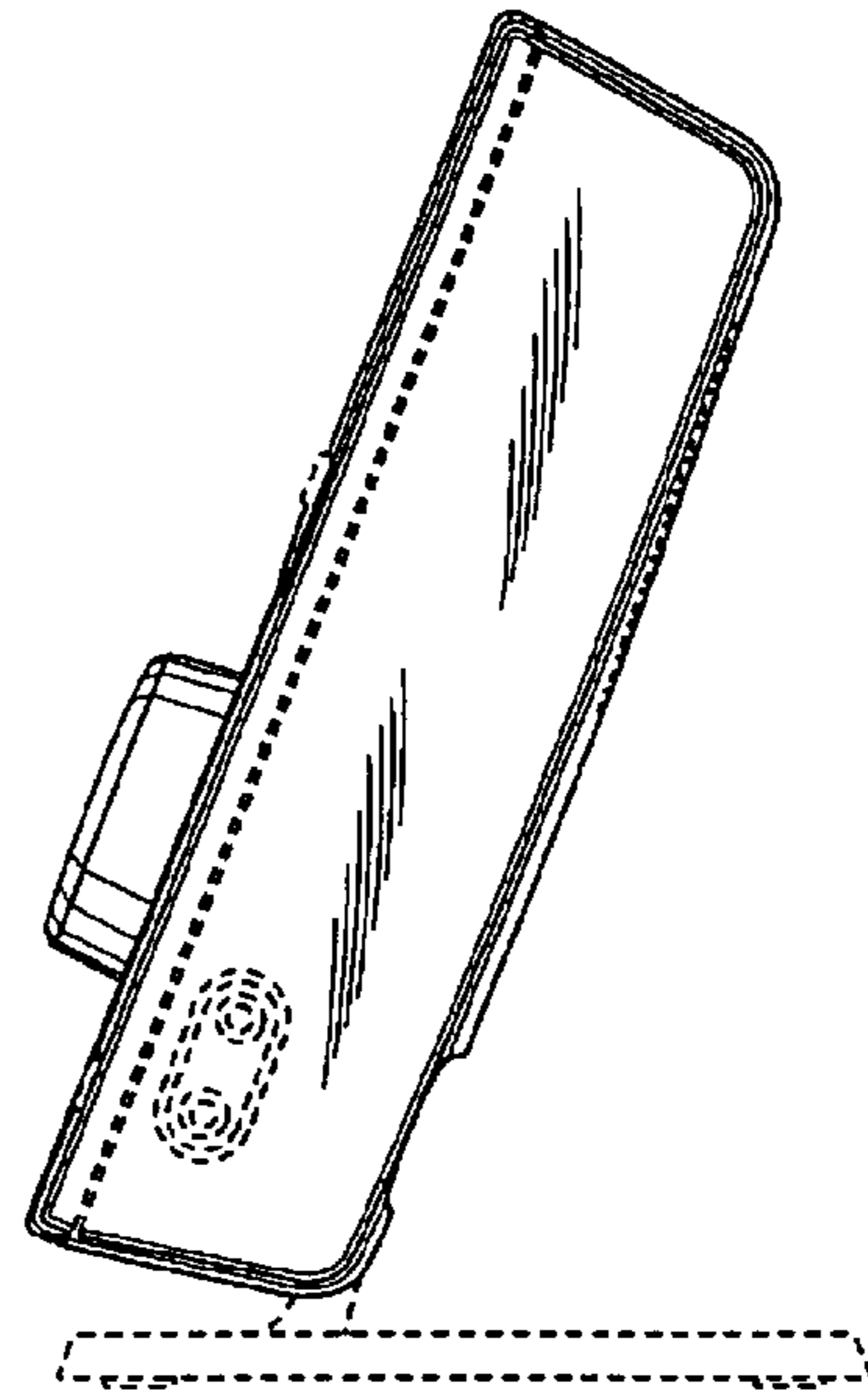

FIG. 8

