



US00D510281S

(12) **United States Design Patent**
Emery et al.

(10) **Patent No.:** **US D510,281 S**
(45) **Date of Patent:** **** Oct. 4, 2005**

(54) **PERFUME WATCH**
(75) Inventors: **R. Blake Emery**, Enumclaw, WA (US);
Kenneth J. Dowd, Issaquah, WA (US);
Kee Sook Jeon, Everett, WA (US)

D317,577 S * 6/1991 Eiss D10/30
D318,808 S * 8/1991 Yum D10/32
D391,175 S * 2/1998 Wunderman D10/32
D480,653 S * 10/2003 Lo D10/32
D497,812 S * 11/2004 Modolo D10/32

(73) Assignee: **The Boeing Company**, Chicago, IL (US)

* cited by examiner

(**) Term: **14 Years**

Primary Examiner—Nelson C. Holtje

(74) *Attorney, Agent, or Firm*—John A. Artz; Artz & Artz, P.C.

(21) Appl. No.: **29/216,584**

(57) **CLAIM**

(22) Filed: **Nov. 5, 2004**

The ornamental design for a perfume watch, as shown and described.

(51) **LOC (8) Cl.** **10-02**

(52) **U.S. Cl.** **D10/32**

(58) **Field of Search** D10/1-39, 122-132;
368/276-277, 281-282, 285, 293-295;
D11/3-25; 63/1.1, 3, 5, 11; 224/164, 168,
178

DESCRIPTION

(56) **References Cited**

U.S. PATENT DOCUMENTS

442,377 A * 12/1890 Hull 368/207
D44,048 S * 5/1913 Worms D10/32
D49,761 S * 10/1916 Kennon D21/460
D145,831 S * 10/1946 Arpels D10/32
2,482,660 A * 9/1949 Dewey 224/179
2,840,286 A * 6/1958 Schermerhorn 224/172
D186,818 S * 12/1959 Cole D10/32
D310,333 S * 9/1990 Fong D10/32

FIG. 1 is a perspective view of the design of a perfume watch;

FIG. 2 is a front view of the design of a perfume watch;

FIG. 3 is a back view of the design of a perfume watch;

FIG. 4 is a top view of the design of a perfume watch;

FIG. 5 is a bottom view of the design of a perfume watch;

FIG. 6 is one side view of the design of a perfume watch;

and,

FIG. 7 is the other side view of the design of a perfume watch.

The broken line showings of a dial and other small portions of the watch are for illustrative purposes only and form no part of the claimed design.

1 Claim, 2 Drawing Sheets

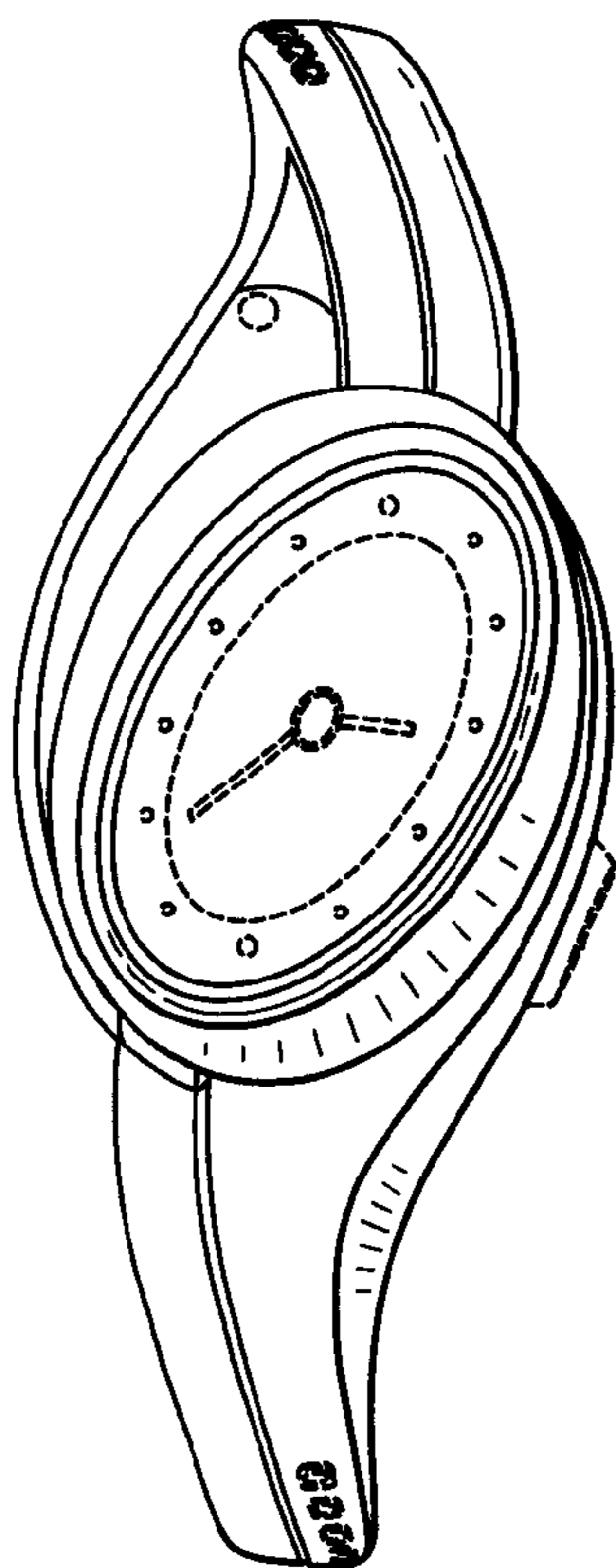

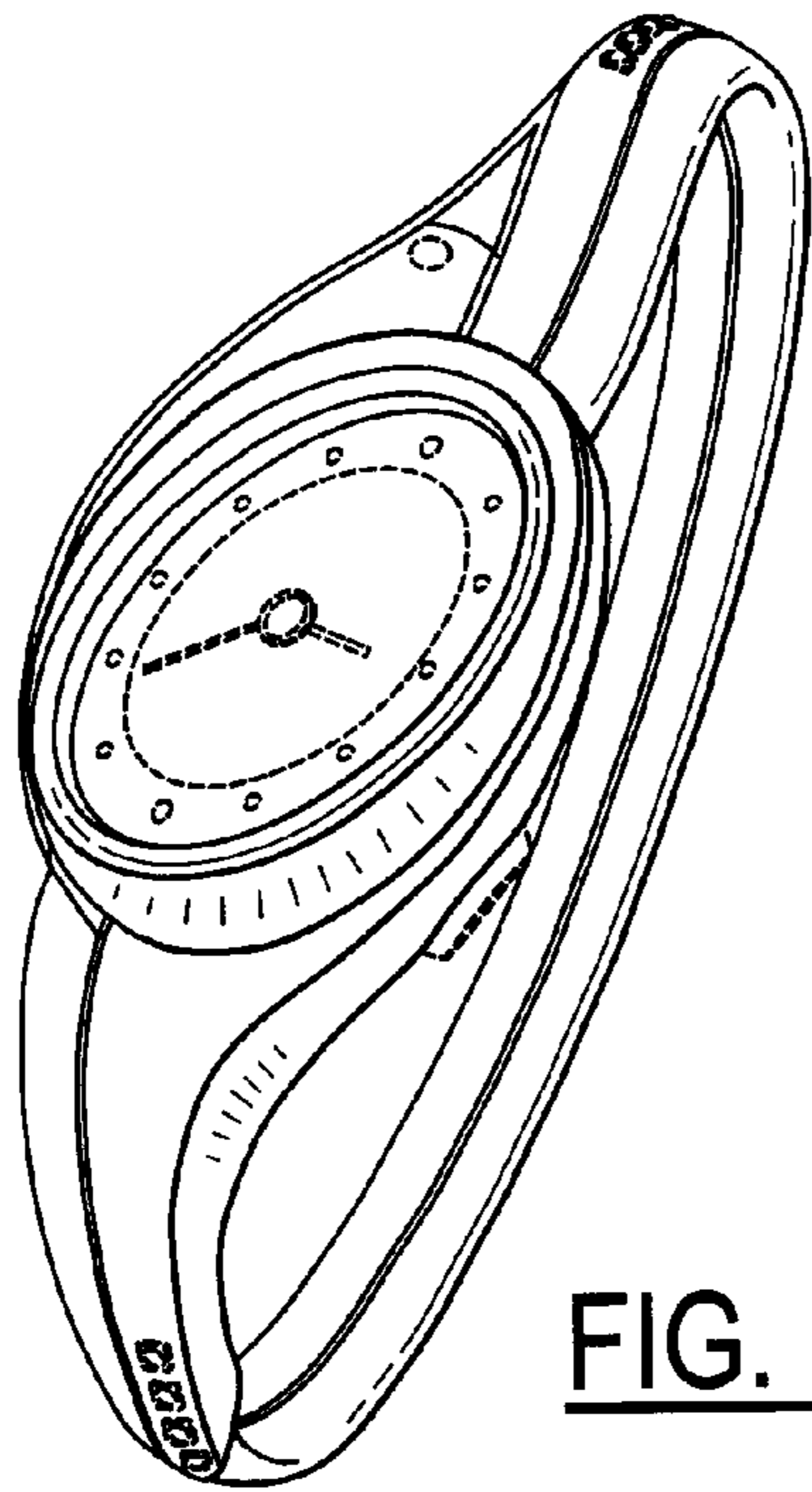

FIG. 1

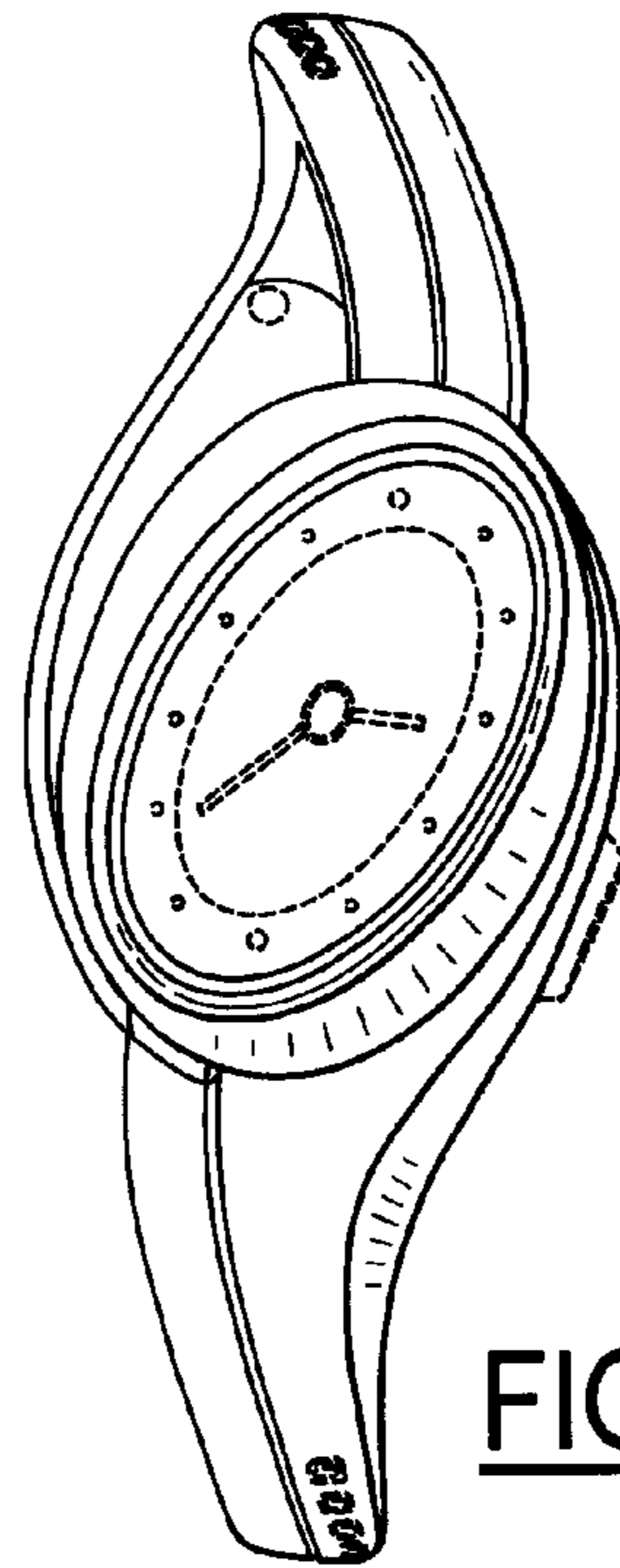

FIG. 2

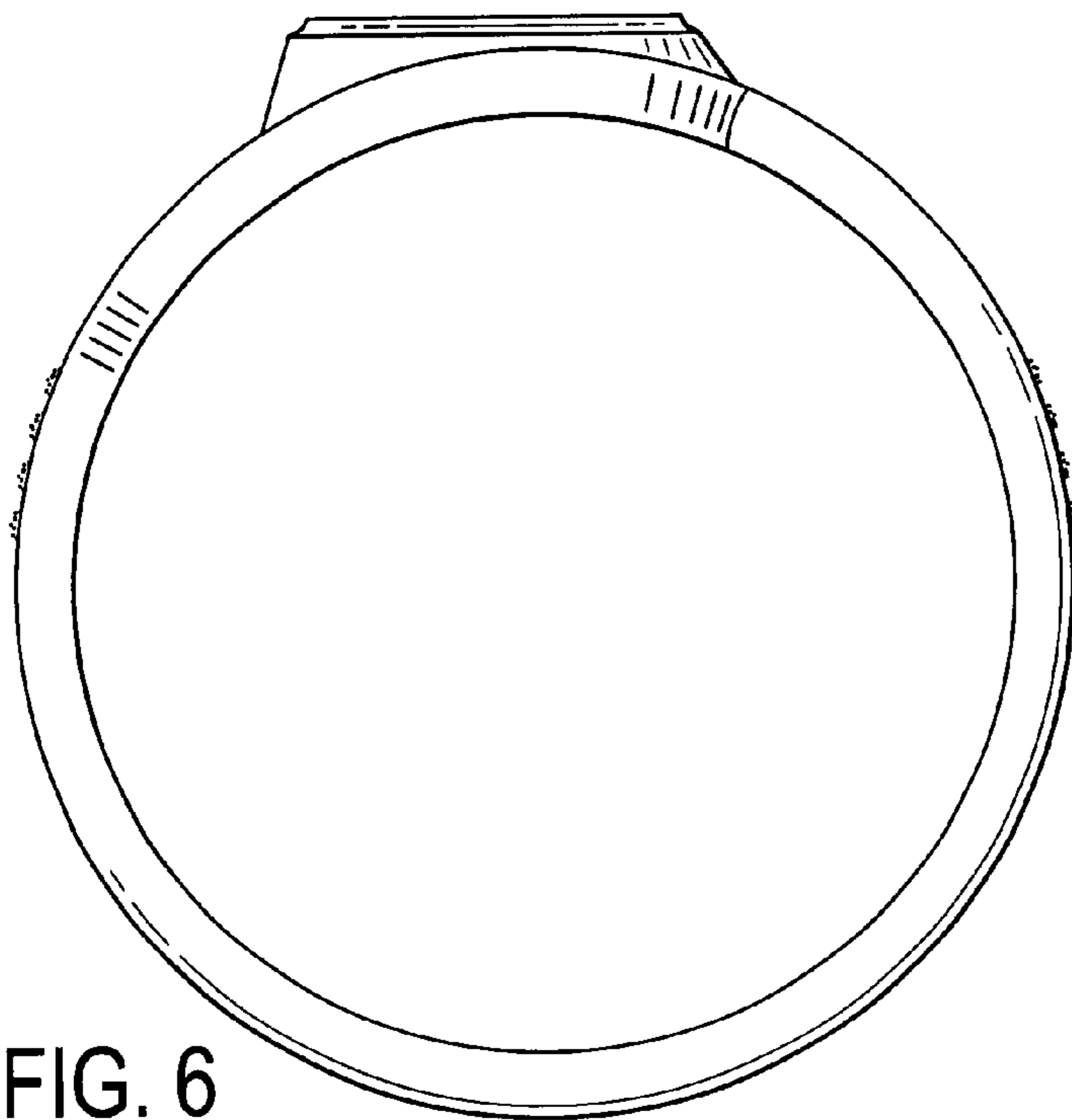

FIG. 6

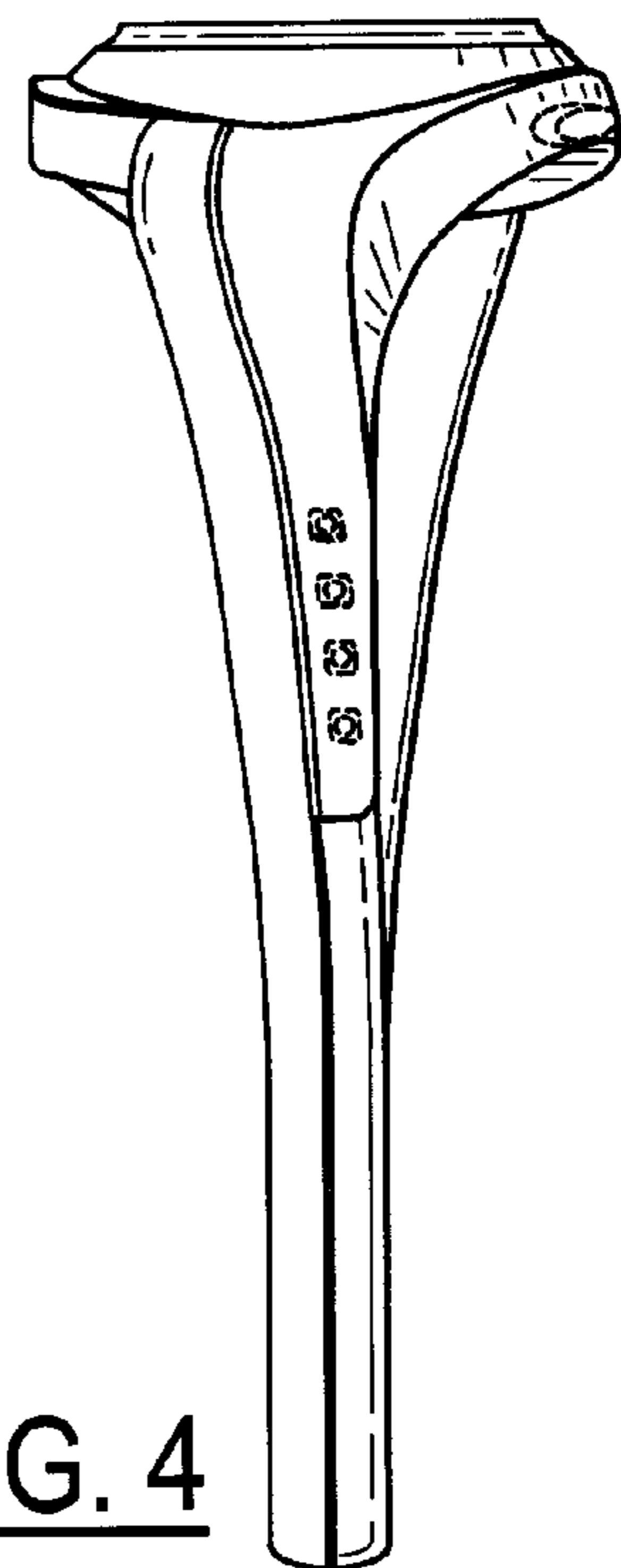

FIG. 4

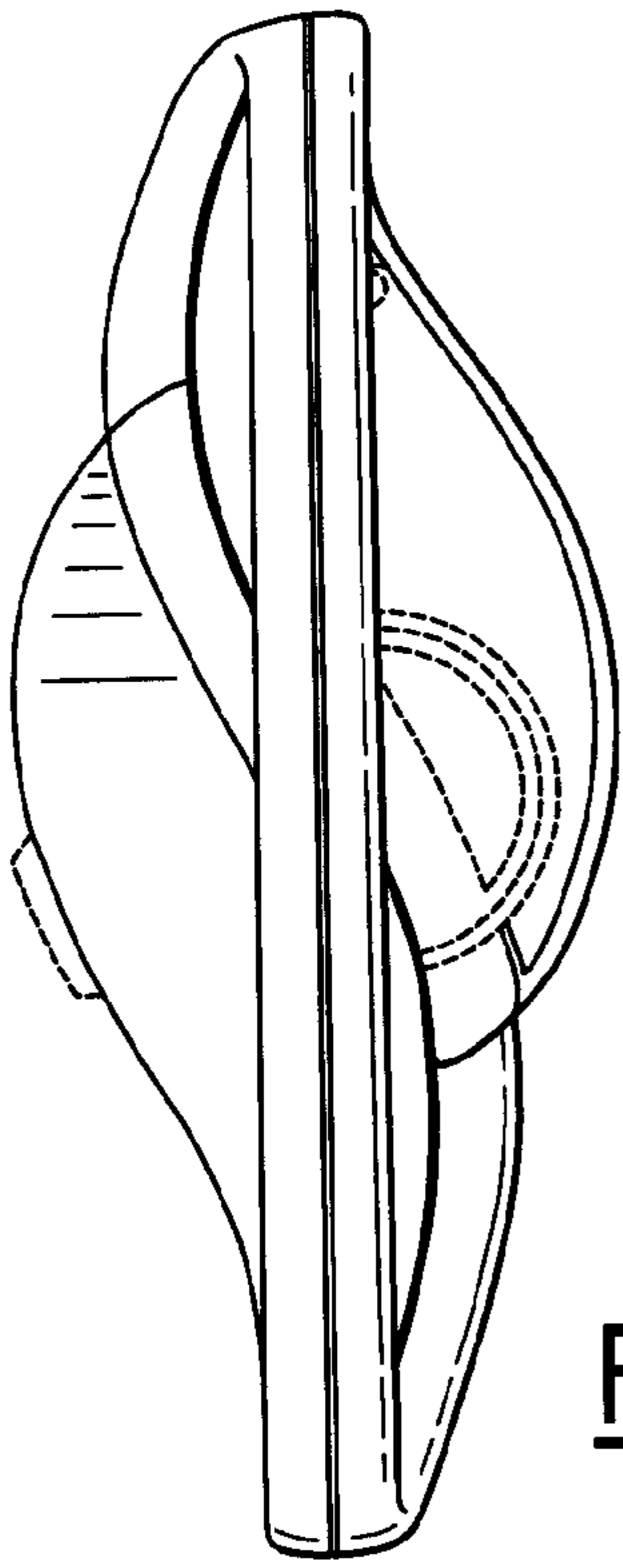

FIG. 3

FIG. 5

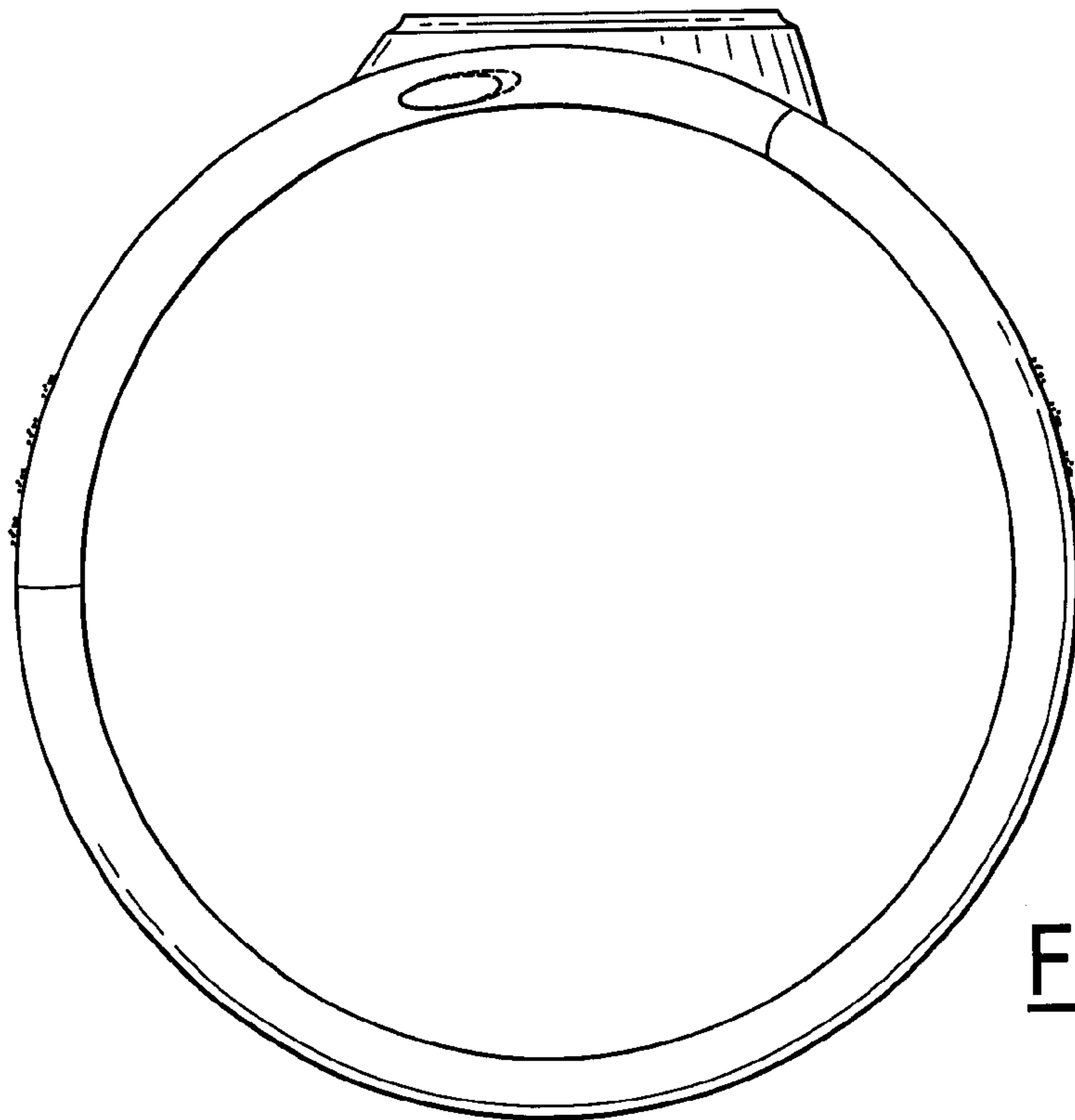
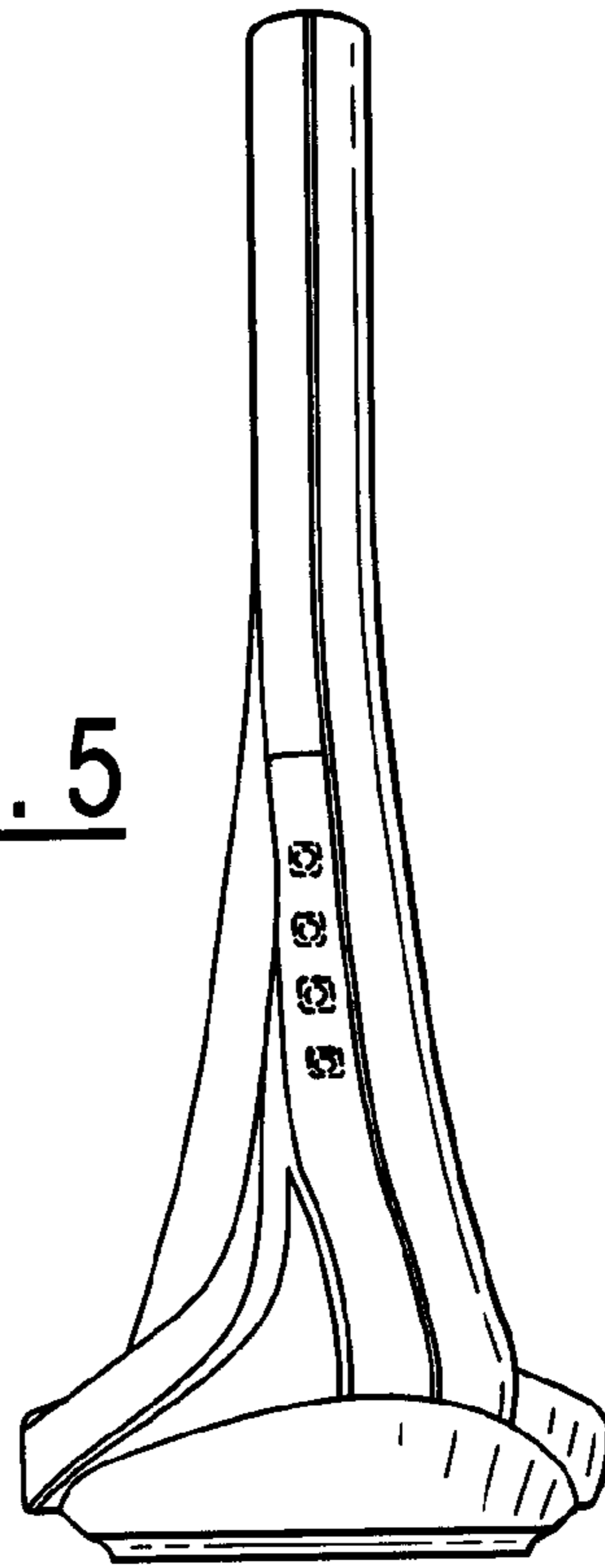

FIG. 7