



US00D510247S

(12) **United States Design Patent**
White

(10) **Patent No.:** **US D510,247 S**

(45) **Date of Patent:** **** Oct. 4, 2005**

(54) **POWER TOOL HANDLE**

(75) **Inventor:** **Matthew White, West Sussex (GB)**

(73) **Assignee:** **B & Q PLC, Eastleigh (GB)**

(**) **Term:** **14 Years**

(21) **Appl. No.:** **29/158,761**

(22) **Filed:** **Apr. 8, 2002**

(30) **Foreign Application Priority Data**

Oct. 9, 2001 (GB) 2105411

(51) **LOC (8) Cl.** **08-03**

(52) **U.S. Cl.** **D8/68; D8/107**

(58) **Field of Search** D8/61, 68, 107;
173/145, 164, 170, 213, 217; 81/489, 177.1,
436-440; 16/110.1

(56) **References Cited**

U.S. PATENT DOCUMENTS

1,980,087 A * 11/1934 Rast 81/489
D187,126 S * 1/1960 Taylor D8/82
D229,023 S * 11/1973 Laurenti D8/61
D242,897 S * 1/1977 Lundmark D8/107
D279,254 S * 6/1985 Smith et al. D8/107

4,768,406 A * 9/1988 Fitzwater 81/177.1
D369,816 S * 5/1996 Kingsley et al. D15/142
D380,363 S * 7/1997 Macor D8/83

* cited by examiner

Primary Examiner—Clare E Heflin

(74) *Attorney, Agent, or Firm*—Heller Ehrman White & McAuliffe LLP

(57) **CLAIM**

The ornamental design for a power tool handle, as shown and described.

DESCRIPTION

FIG. 1 is a top view of the power tool handle.
FIG. 2 is a bottom view of the power tool handle.
FIG. 3 is a left side view of the power tool handle.
FIG. 4 is a right side view of the power tool handle.
FIG. 5 is a front view of the power tool handle.
FIG. 6 is a rear view of the power tool handle.
FIG. 7 is a right rear perspective view of the power tool handle; and,
FIG. 8 is a left front perspective view of the power tool handle.

The broken lines shown on the drawings are for illustrative purposes only and form no part of the claimed design.

1 Claim, 4 Drawing Sheets

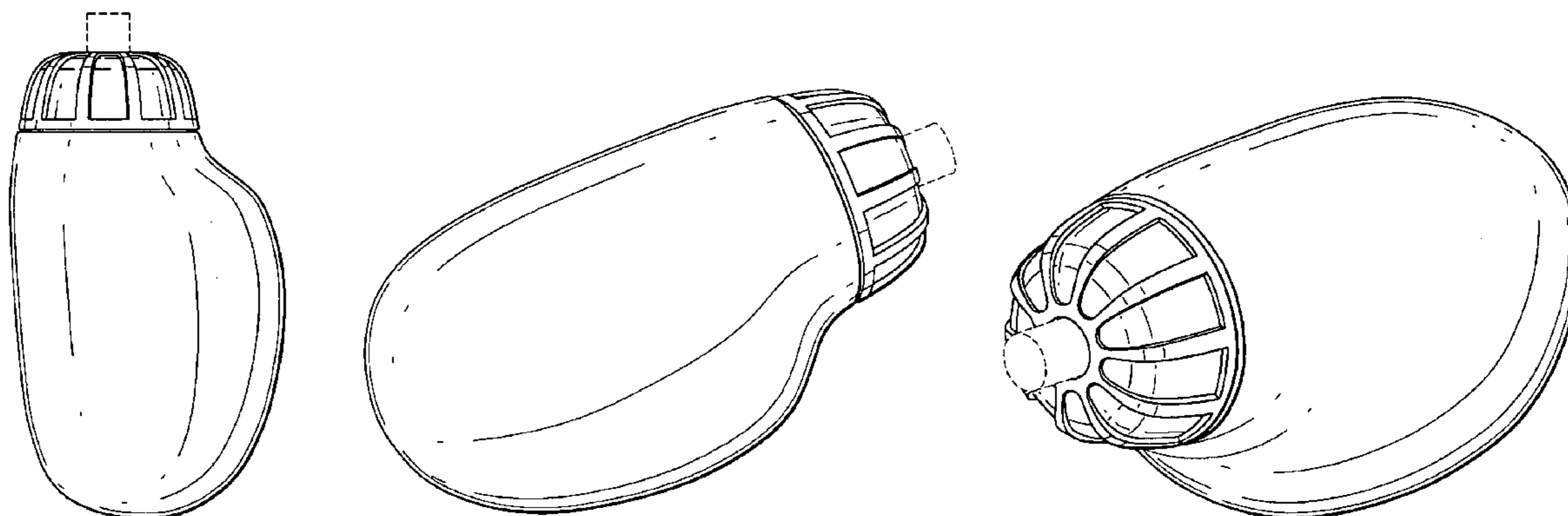

FIG. 1



FIG. 2

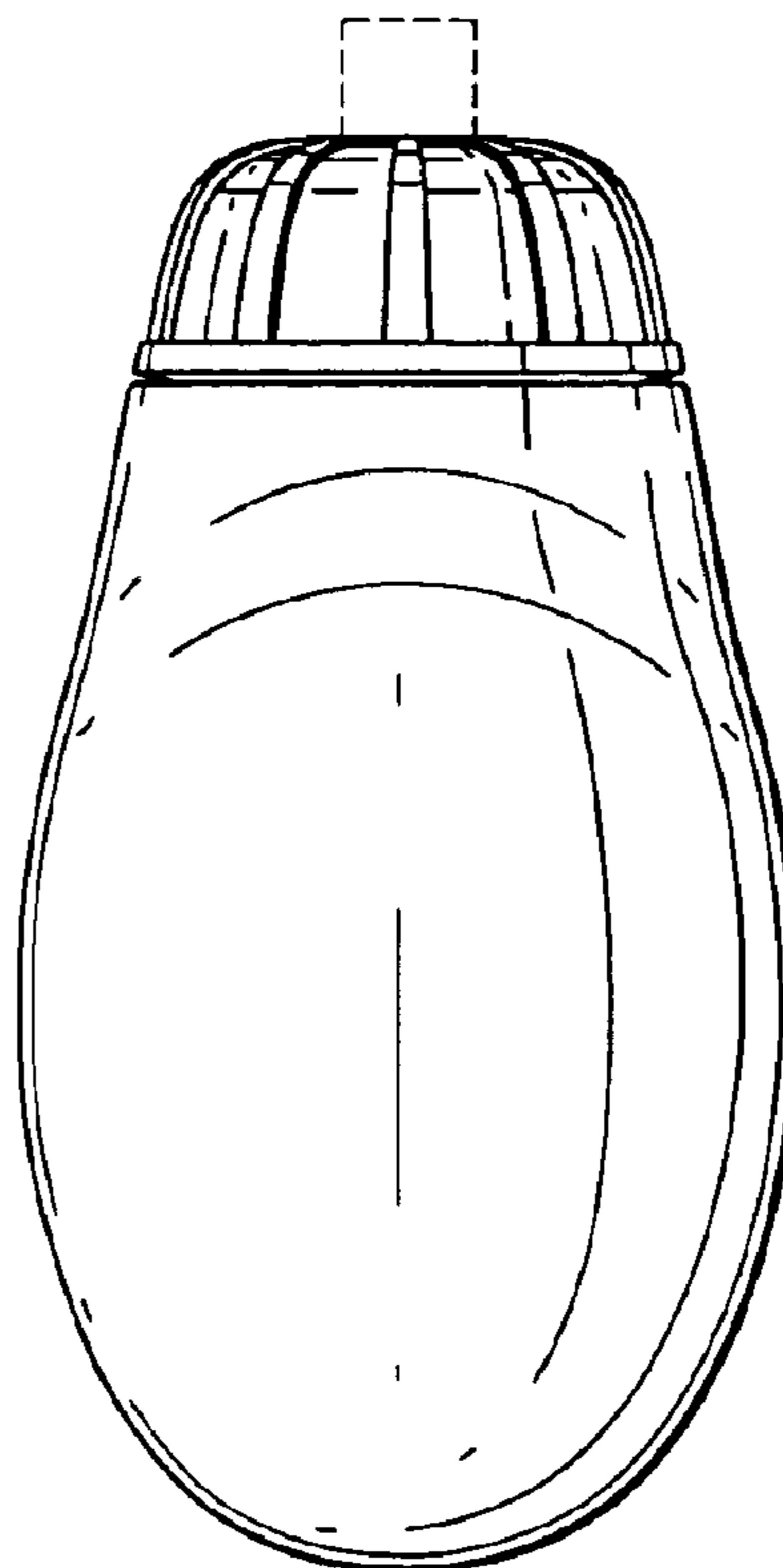

FIG. 3

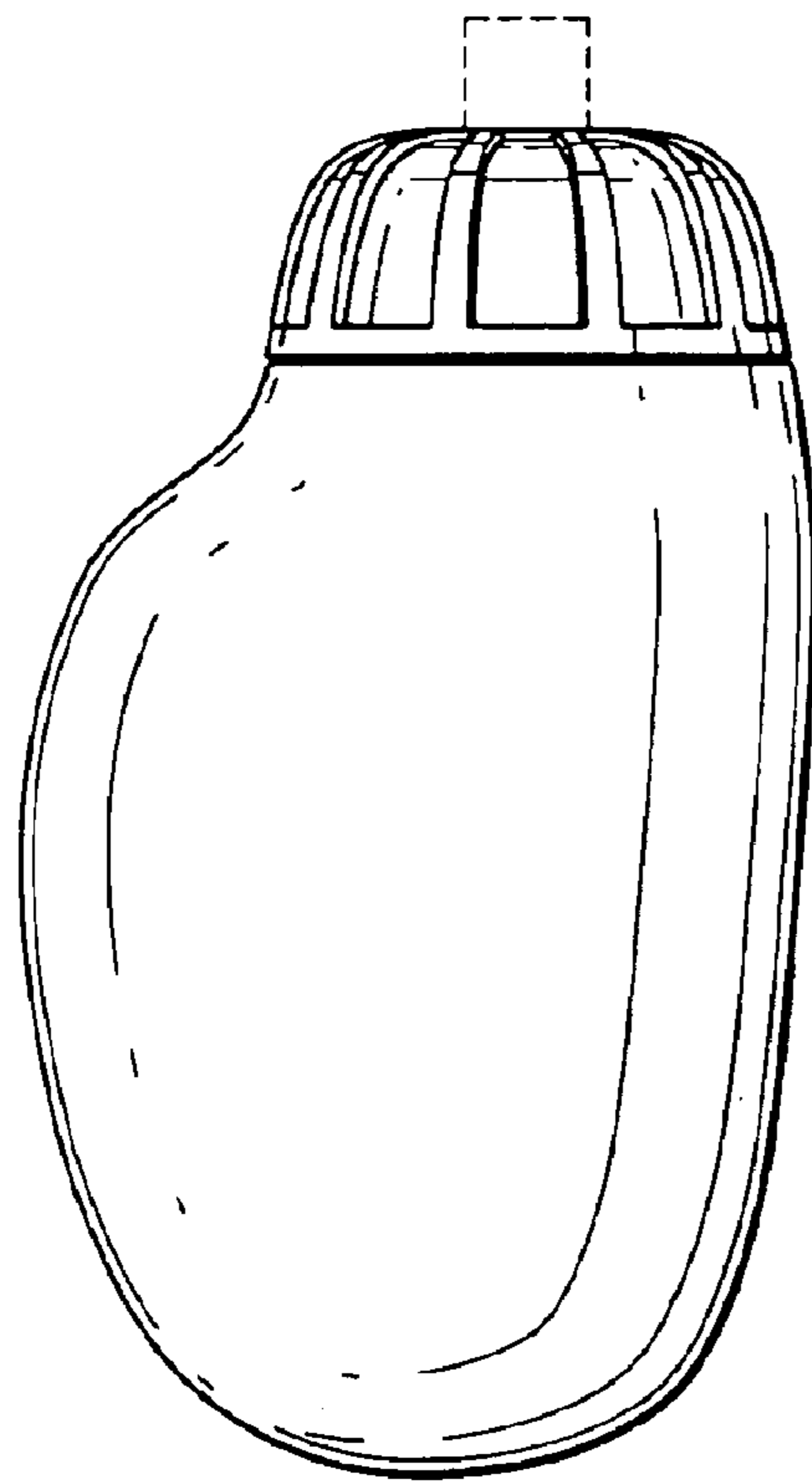

FIG. 4

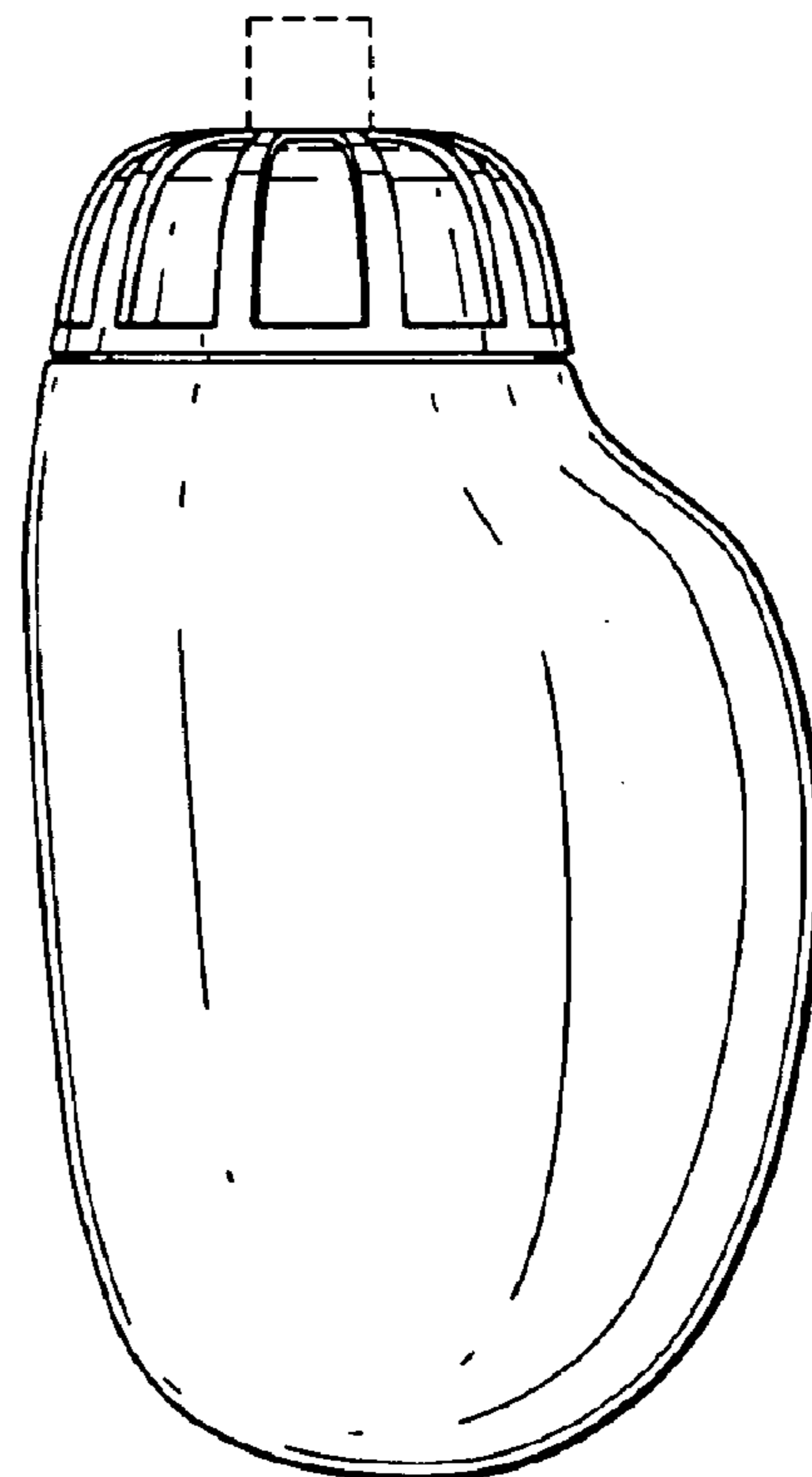

FIG. 5

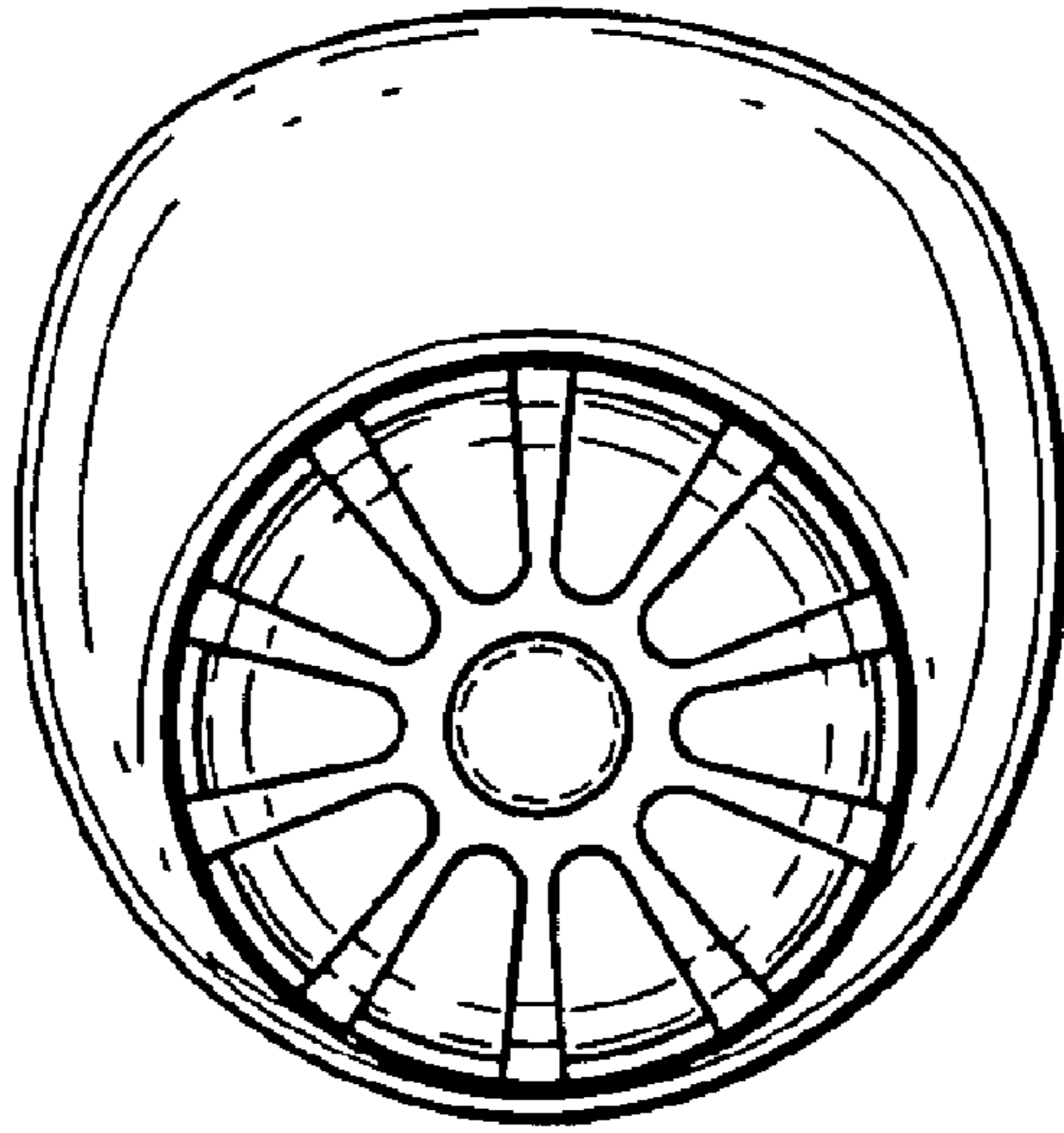

FIG. 6

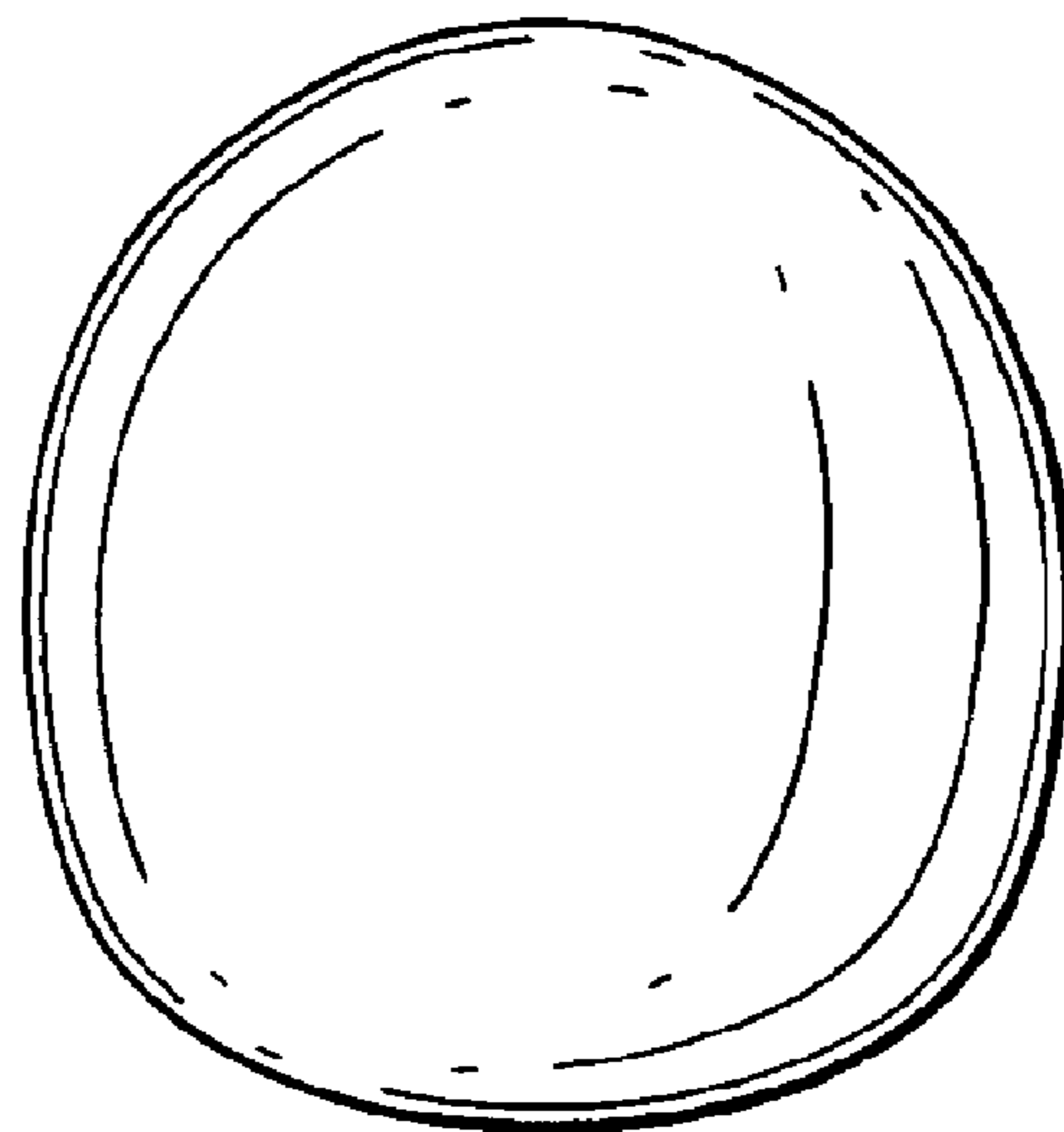

FIG. 7

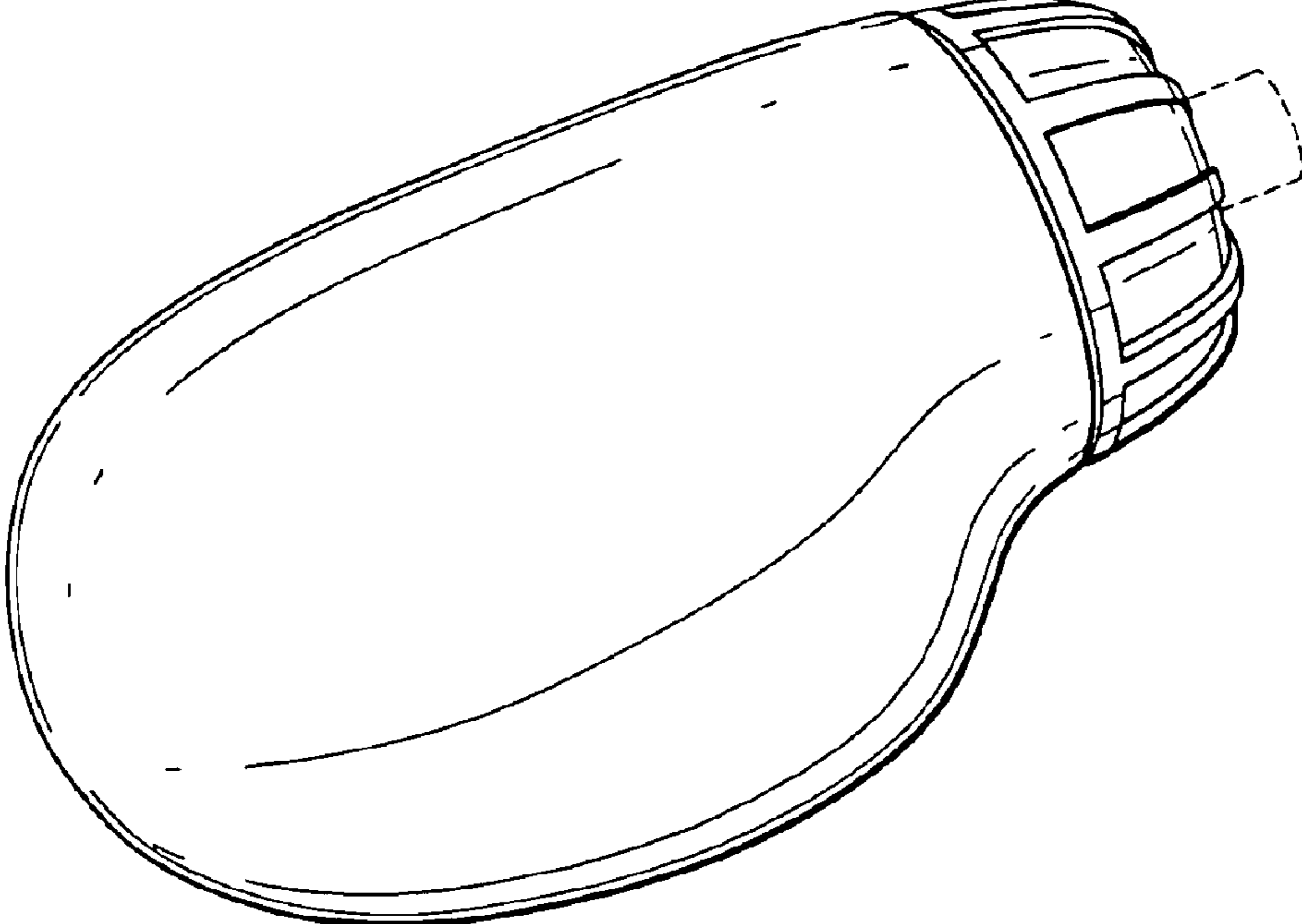

FIG. 8

