



US00D510232S

(12) **United States Design Patent**
Varelli

(10) **Patent No.:** **US D510,232 S**
(45) **Date of Patent:** **** Oct. 4, 2005**

(54) **UNIVERSAL EASY POUR HOLDER**

(76) **Inventor:** **Michael R. Varelli**, 4680 Monticello Blvd., South Euclid, OH (US) 44143

(**) **Term:** **14 Years**

(21) **Appl. No.:** **29/204,523**

(22) **Filed:** **Apr. 30, 2004**

(51) **LOC (8) Cl.** **07-02**

(52) **U.S. Cl.** **D7/393**

(58) **Field of Search** D7/393, 394-395;
D8/300, 315-320; D9/434; D18/35-43,
56

(56) **References Cited**

U.S. PATENT DOCUMENTS

D279,161 S	*	6/1985	Gould	D7/393
D386,682 S	*	11/1997	Richardson et al.	D9/434
D419,030 S	*	1/2000	Liu	D7/393
D483,799 S	*	12/2003	Kadota	D8/315

* cited by examiner

Primary Examiner—Ruth McInroy

Assistant Examiner—Terrence Huang

(74) *Attorney, Agent, or Firm*—Joseph H. Taddeo

(57) **CLAIM**

The ornamental design for a universal easy pour holder, as shown and described.

DESCRIPTION

FIG. 1 is a front view for a universal easy pour holder of my new design;

FIG. 2 is back view thereof;

FIG. 3 is a right side view thereof;

FIG. 4 is a left side view thereof;

FIG. 5 is a top view thereof;

FIG. 6 is a bottom view thereof;

FIG. 7 is a perspective view thereof; and,

FIG. 8 is a reduced perspective view thereof, attached to the bowl.

The broken line showing of the hand and bowl is for illustrative purposes only and forms no part of the claimed design.

1 Claim, 4 Drawing Sheets

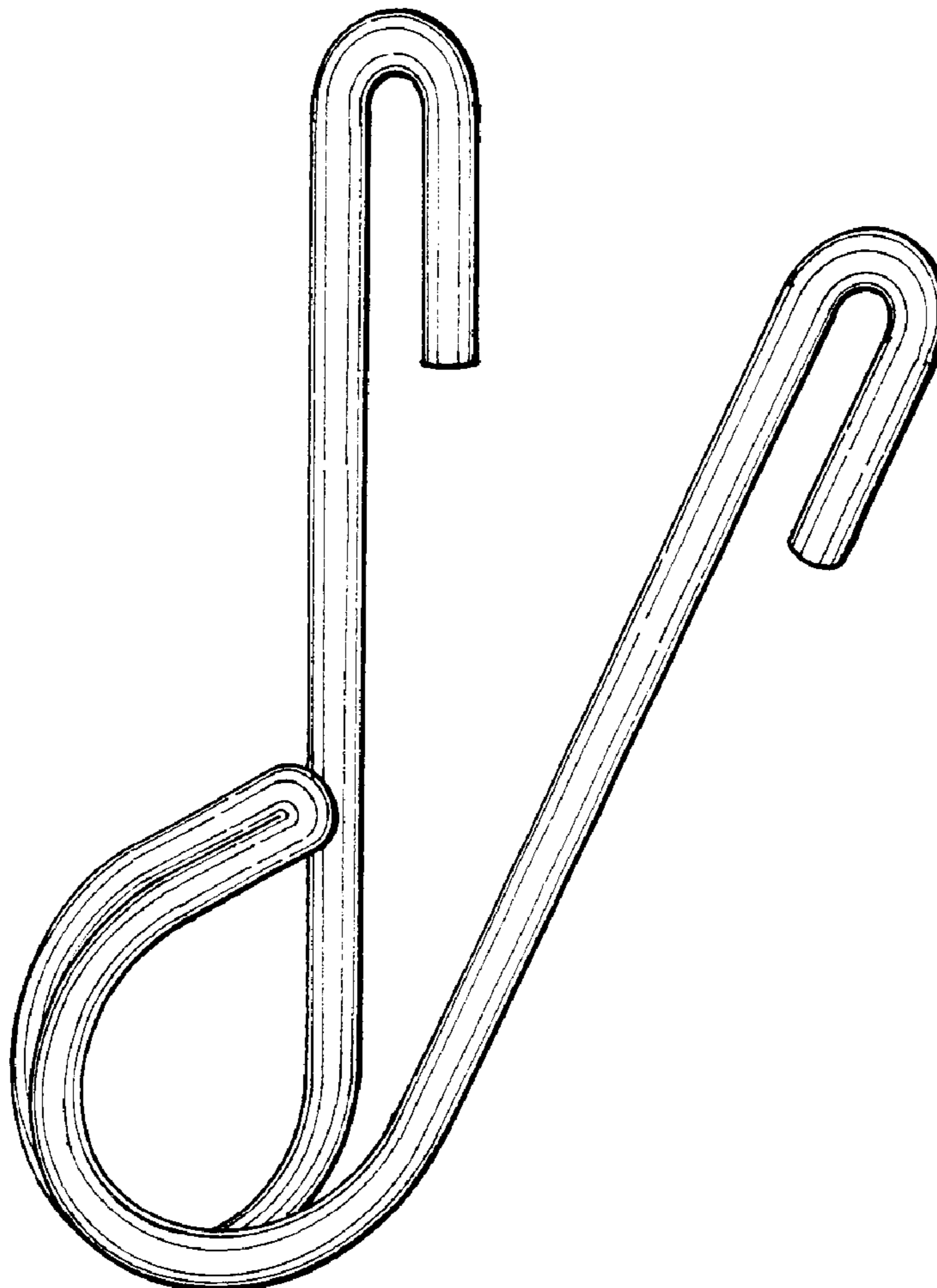

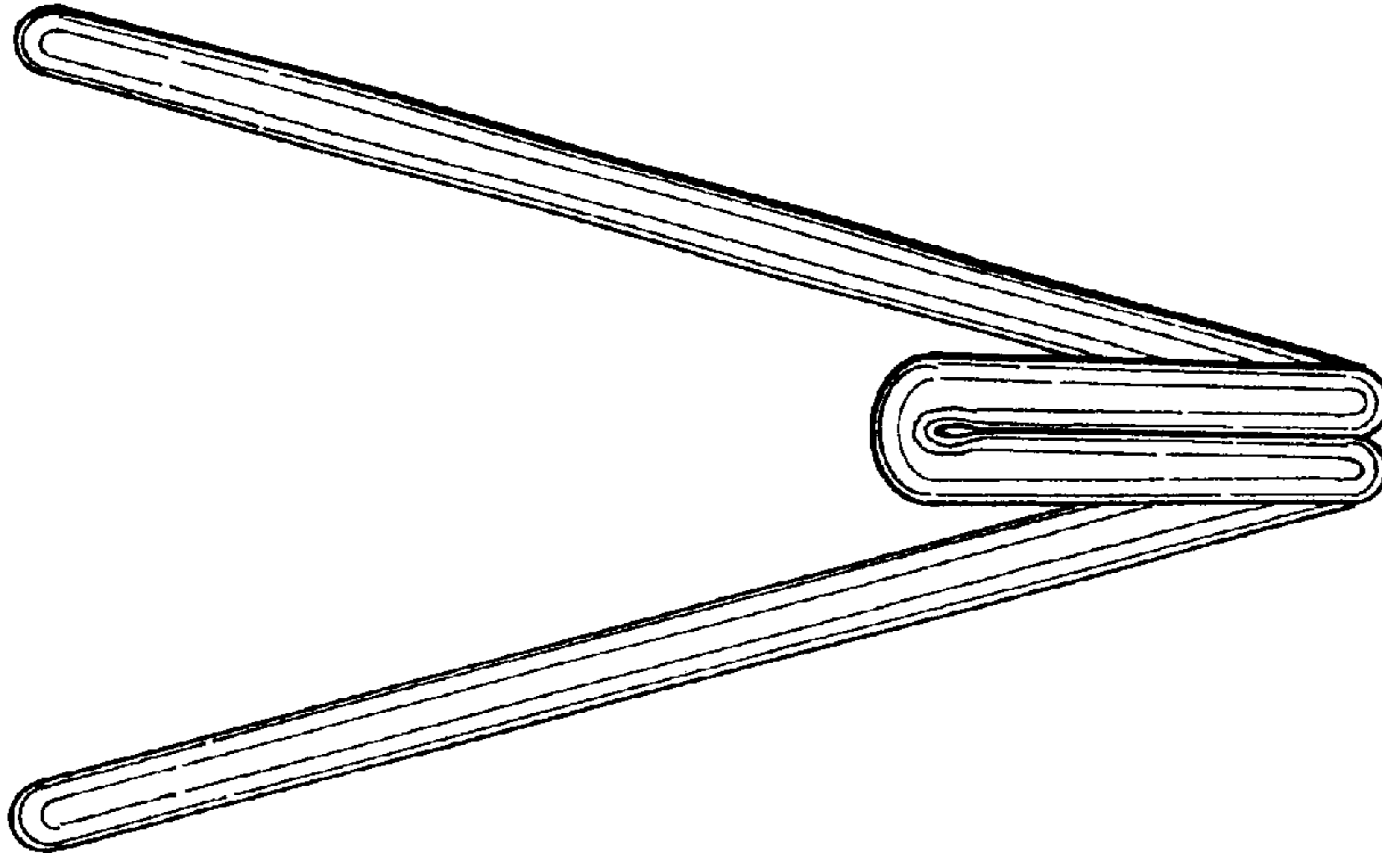

FIG. 2

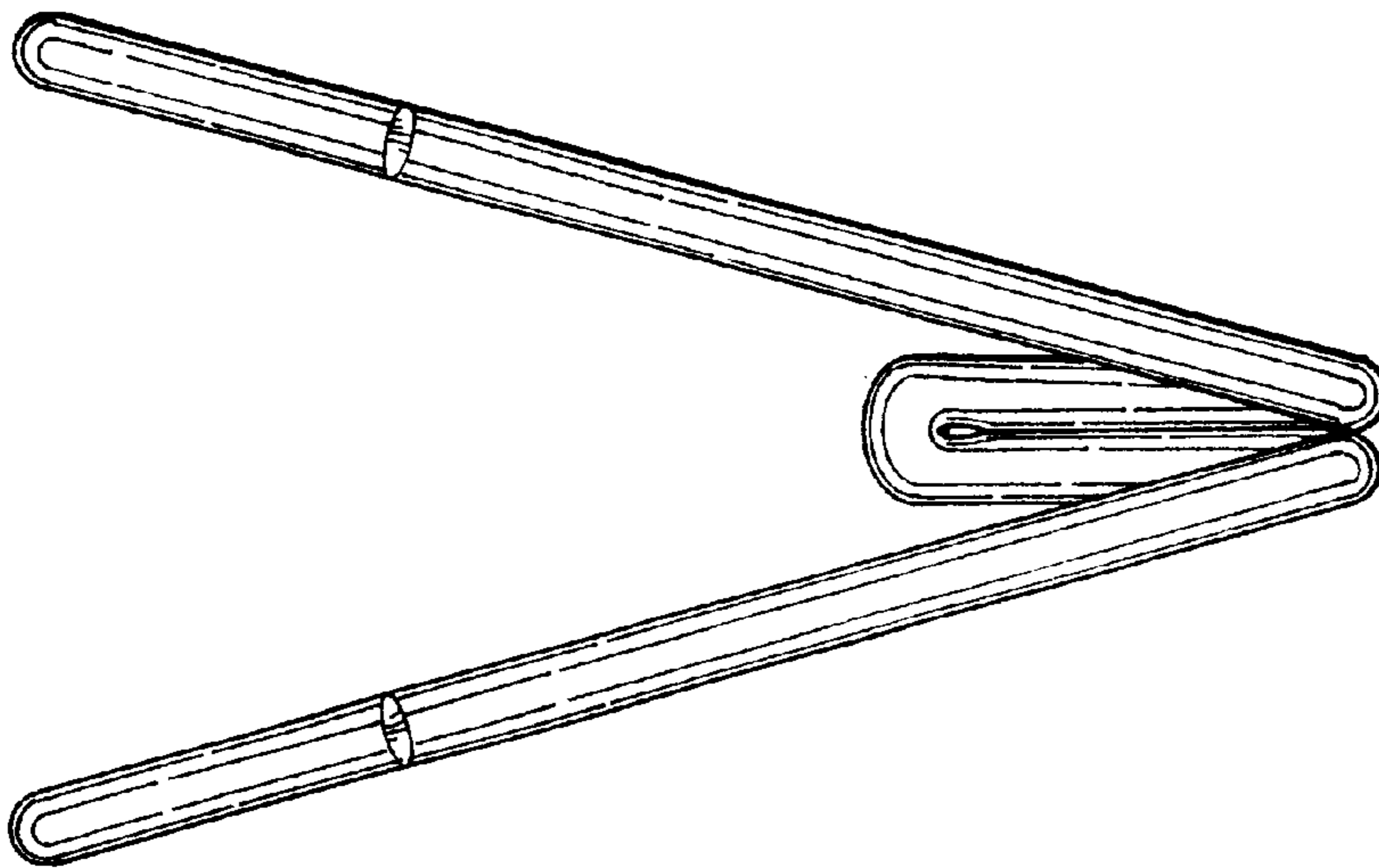

FIG. 1

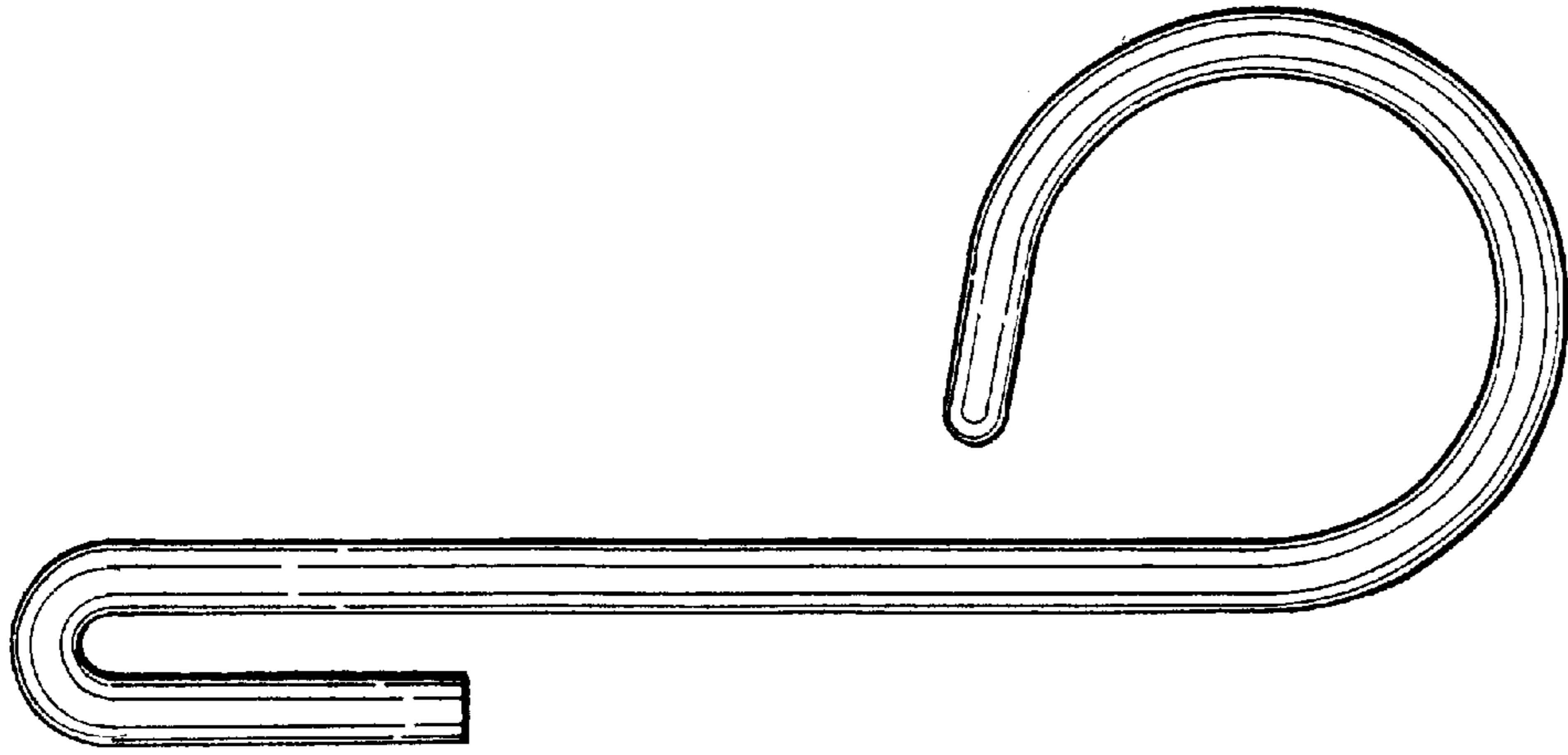

FIG. 4

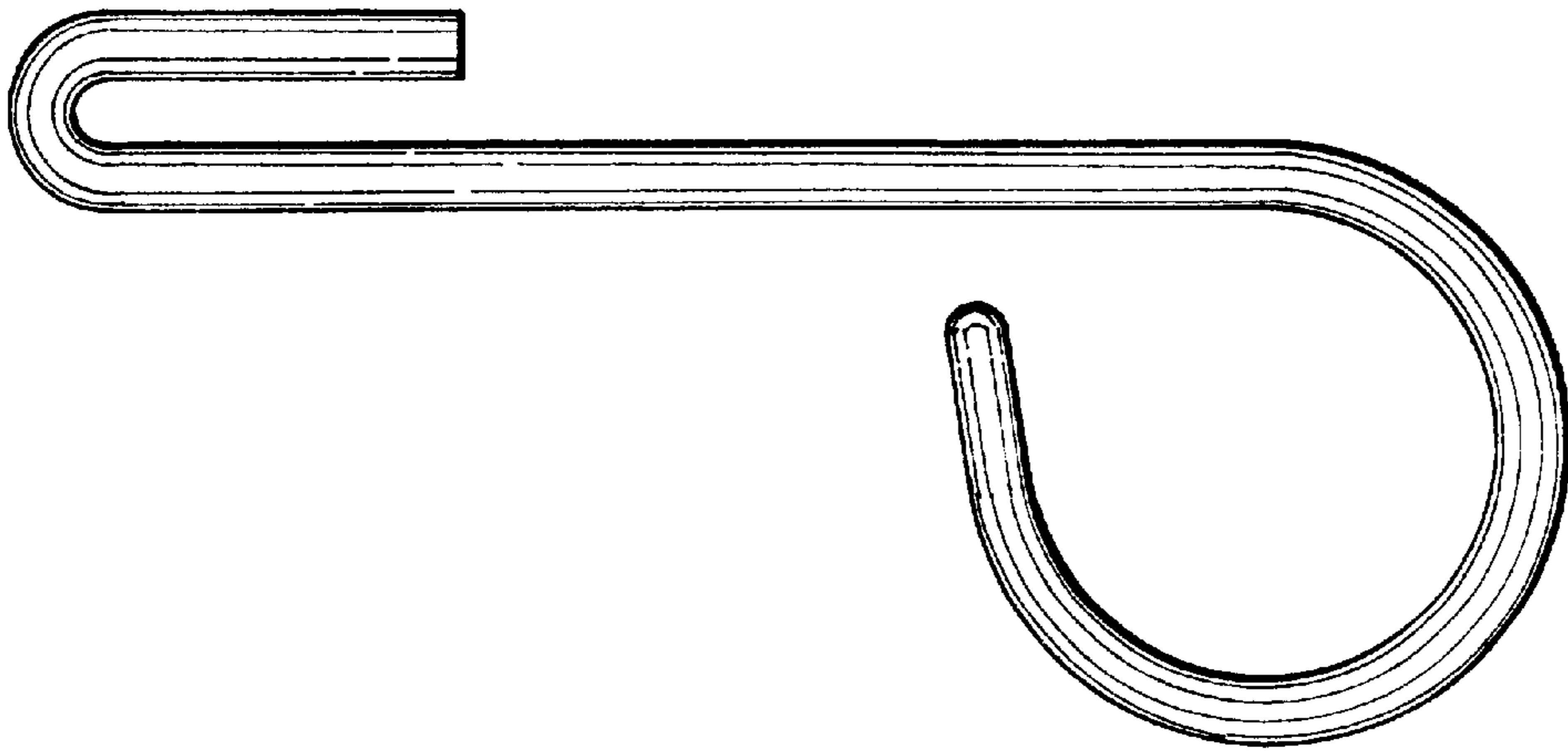

FIG. 3

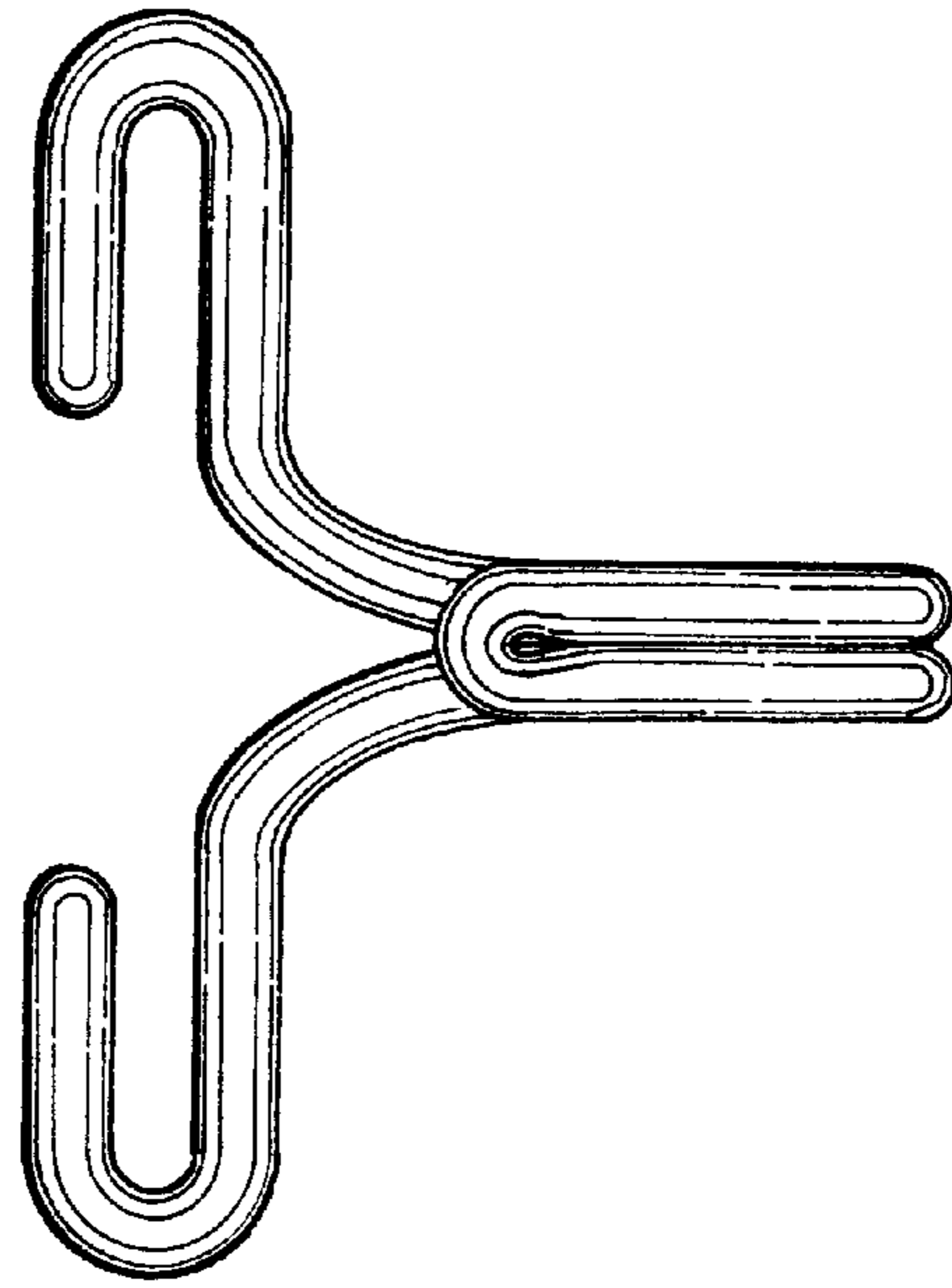

FIG. 6

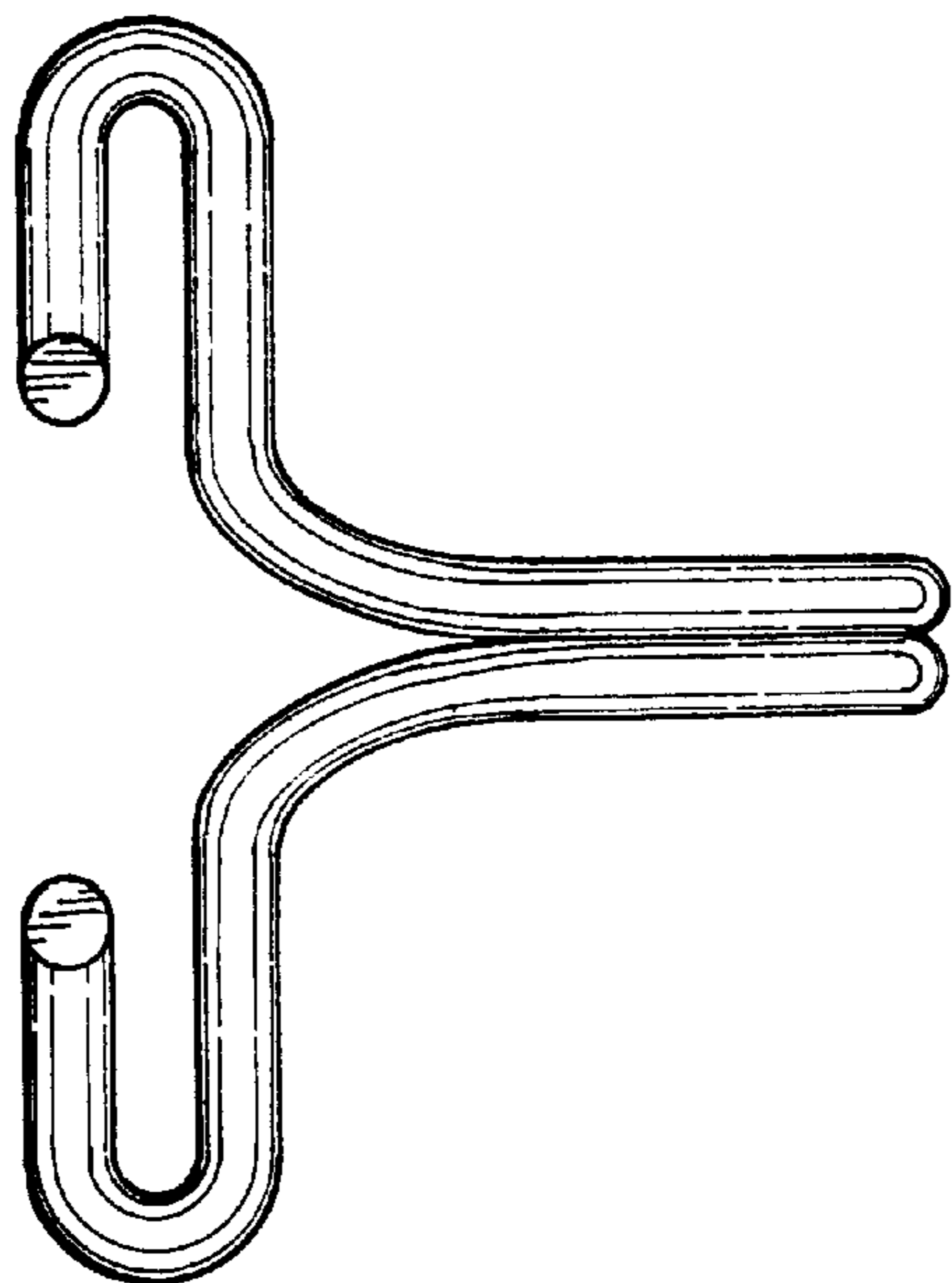

FIG. 5

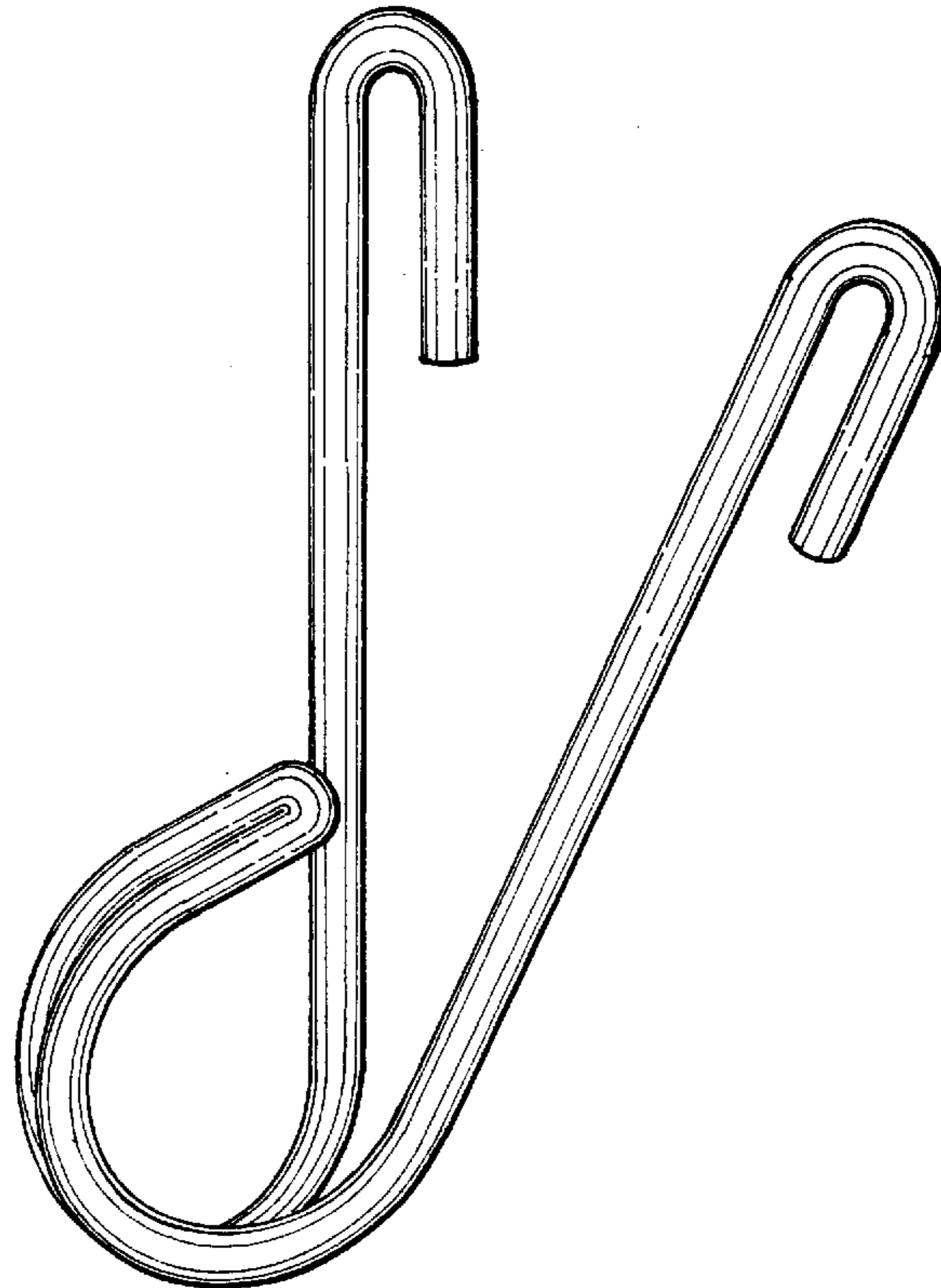

FIG. 7

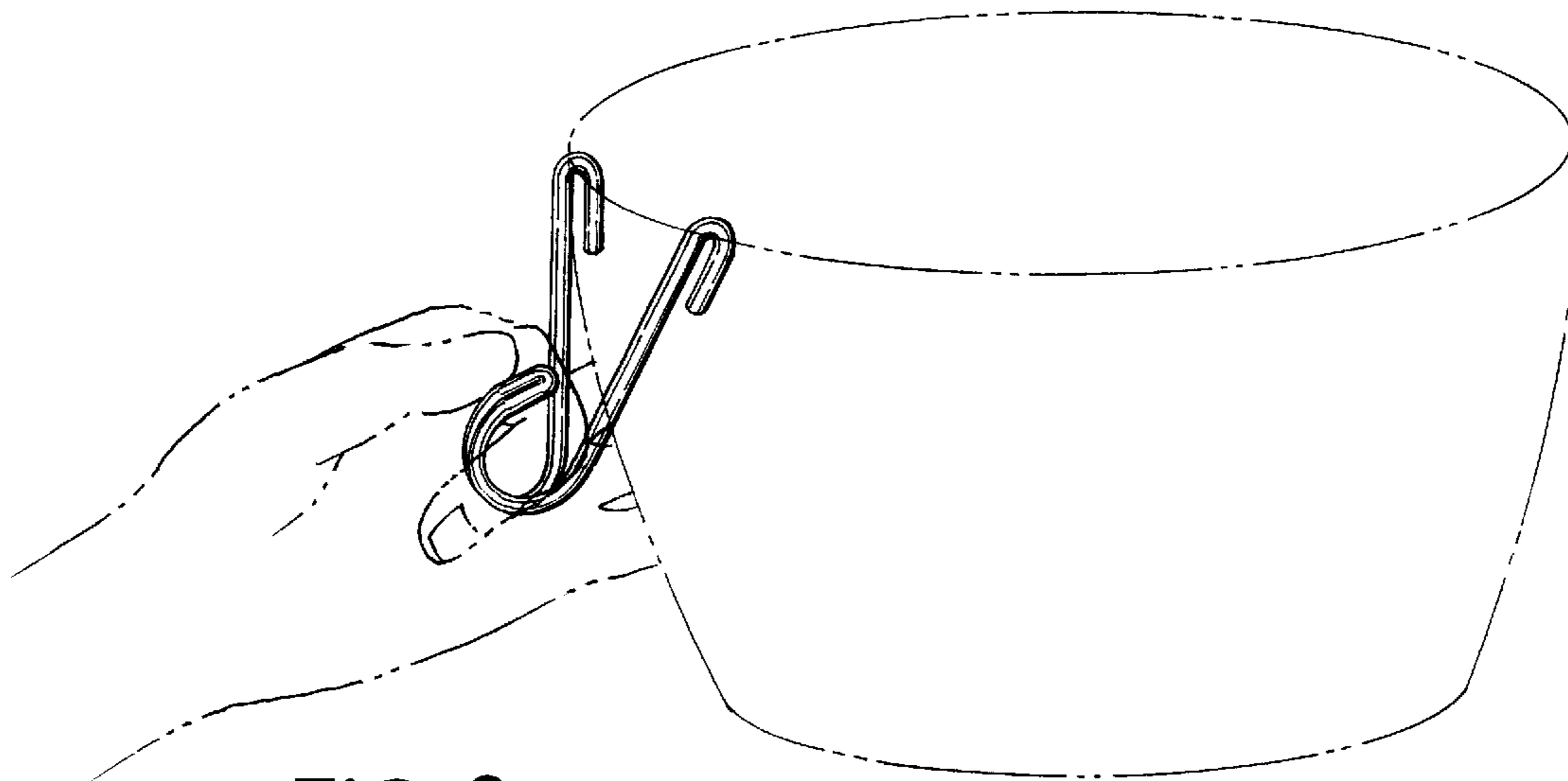

FIG. 8