



US00D510230S

(12) **United States Design Patent** (10) **Patent No.:** **US D510,230 S**
Taira (45) **Date of Patent:** **** Oct. 4, 2005**

(54) **OVEN**
 (75) Inventor: **Tomoki Taira**, Osaka-fu (JP)
 (73) Assignee: **Sharp Kabushiki Kaisha**, Osaka (JP)
 (**) Term: **14 Years**
 (21) Appl. No.: **29/208,912**
 (22) Filed: **Jul. 8, 2004**
 (30) **Foreign Application Priority Data**
 Jan. 8, 2004 (JP) 2004-000213
 (51) **LOC (8) Cl.** **07-02**
 (52) **U.S. Cl.** **D7/351**
 (58) **Field of Search** D7/350.1, 350.3,
 D7/350.4, 351, 402, 405-406; 126/273 A,
 275 R, 275 E, 19 M, 21 R; 219/756-758;
 99/DIG. 14

D410,813 S 6/1999 Fujii
 D410,814 S 6/1999 Koike
 D411,074 S 6/1999 Sakai et al.
 D411,706 S 6/1999 Koike
 D425,750 S 5/2000 Koike
 D426,102 S 6/2000 Hamada et al.
 D431,957 S 10/2000 Taira
 D433,268 S 11/2000 Taira
 D433,269 S 11/2000 Taira
 D435,999 S 1/2001 Noda et al.
 D436,285 S 1/2001 Taira
 D436,793 S 1/2001 Taira
 D442,424 S 5/2001 Naganuma
 D442,821 S 5/2001 Naganuma
 D455,932 S * 4/2002 Noda et al. D7/351
 D463,198 S * 9/2002 Nishikawa D7/351
 D465,963 S * 11/2002 Taira D7/351
 D468,579 S * 1/2003 Sakai et al. D7/351
 D477,964 S * 8/2003 Kanza D7/351
 D478,465 S * 8/2003 Kanza D7/351
 D481,582 S * 11/2003 Seum et al. D7/350.1
 D499,300 S 12/2004 Fukuda et al.

(56) **References Cited**
U.S. PATENT DOCUMENTS
 D329,353 S 9/1992 Yamada
 D334,688 S 4/1993 Kitae et al.
 D335,064 S 4/1993 Sugiyama et al.
 D352,636 S 11/1994 Nakamura
 D353,510 S 12/1994 Nakamura
 D353,511 S 12/1994 Saimen
 D353,512 S 12/1994 Saimen et al.
 D356,006 S 3/1995 Saimen et al.
 D357,159 S 4/1995 Mitsui et al.
 D367,991 S 3/1996 Saimen
 D367,992 S 3/1996 Saimen
 D368,405 S 4/1996 Tada
 D368,406 S 4/1996 Nakamura
 D373,502 S 9/1996 Fujii et al.
 D380,644 S 7/1997 Tsuda et al.
 D390,411 S 2/1998 Nakagawa
 D390,412 S 2/1998 Takimoto

* cited by examiner
Primary Examiner—Ruth McInroy
 (74) *Attorney, Agent, or Firm*—Nixon & Vanderhye

(57) **CLAIM**
 The ornamental design for an oven, as shown and described.

DESCRIPTION
 FIG. 1 is a top, front and right side perspective view of an oven according to my design;
 FIG. 2 is a front elevational view thereof;
 FIG. 3 is a rear elevational view thereof;
 FIG. 4 is a left side elevational thereof;
 FIG. 5 is a right side elevational view thereof;
 FIG. 6 is a top plan view thereof; and,
 FIG. 7 is a bottom plan view thereof.

1 Claim, 5 Drawing Sheets

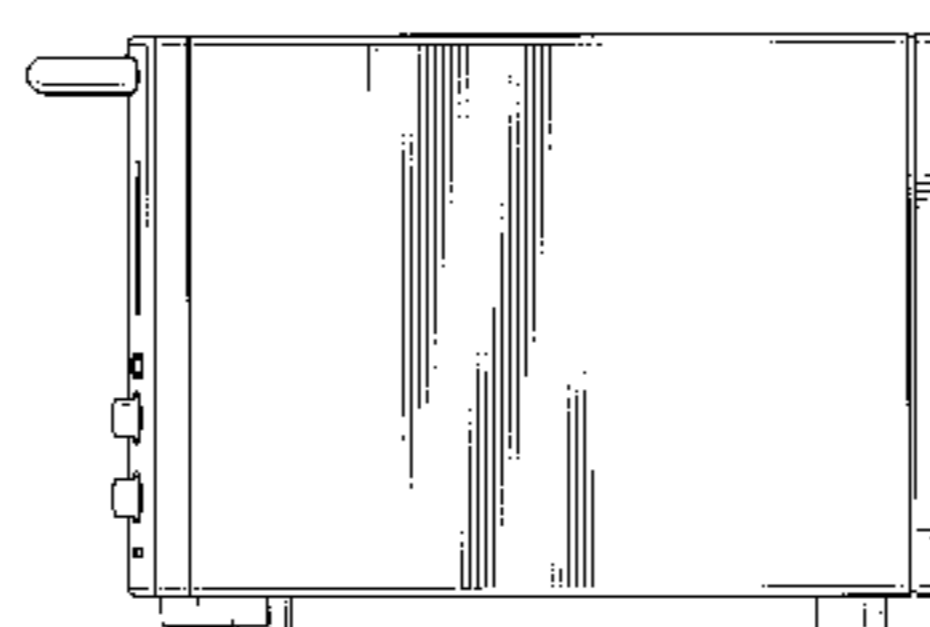
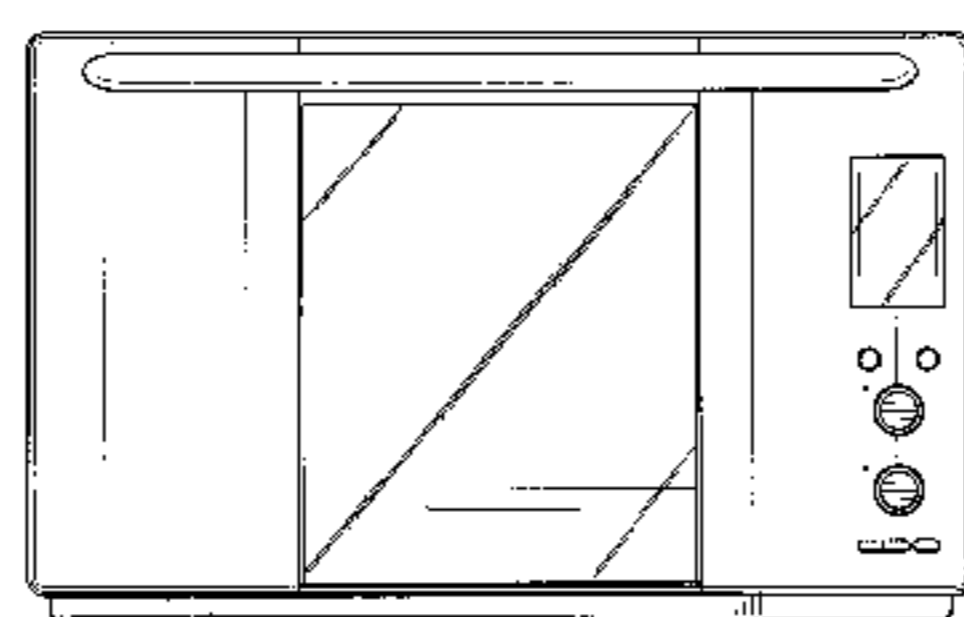
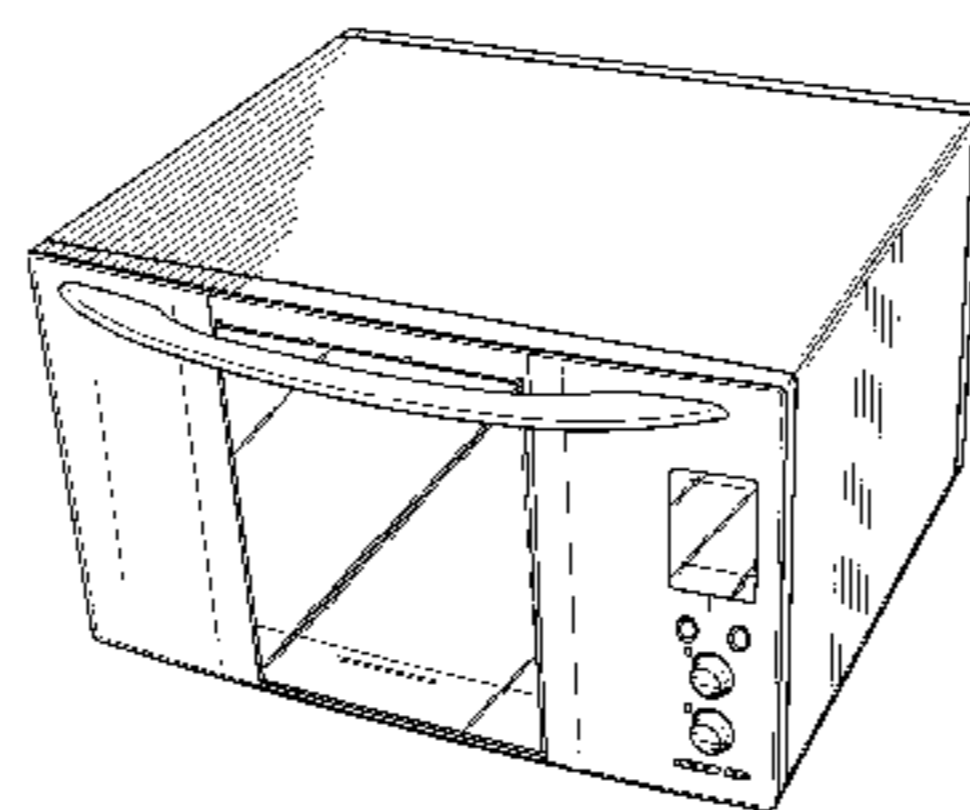

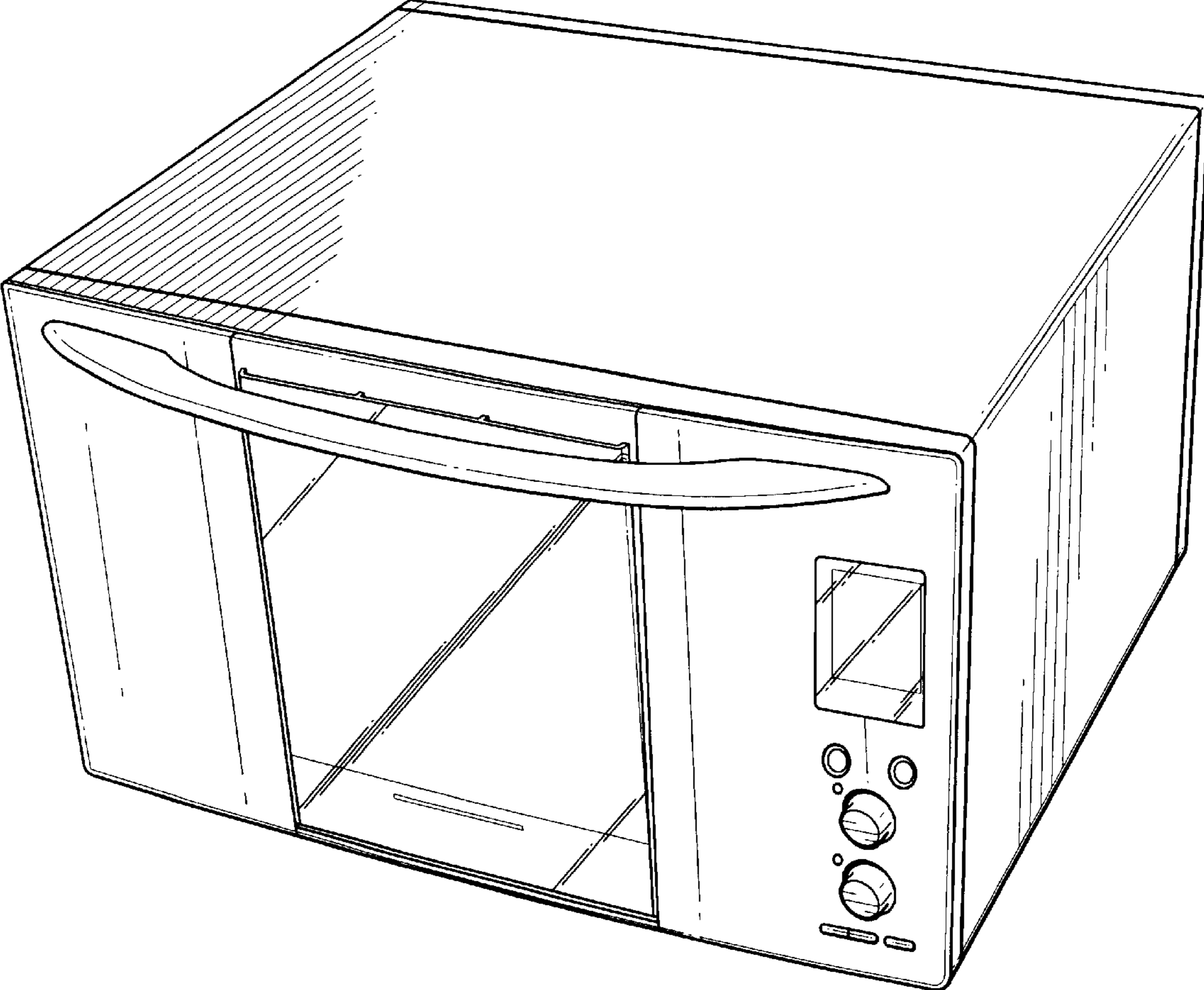

Fig. 1

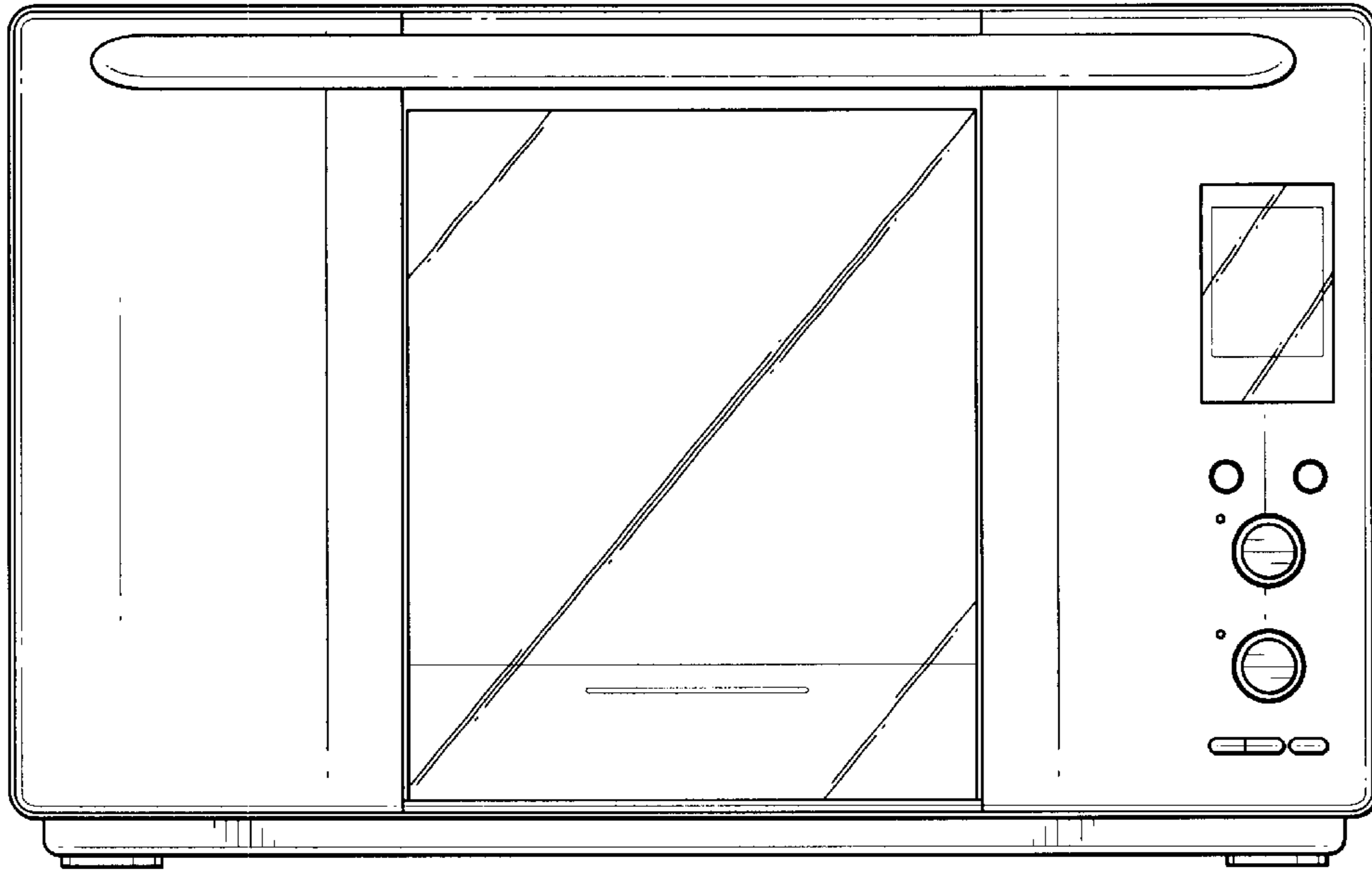

Fig. 2

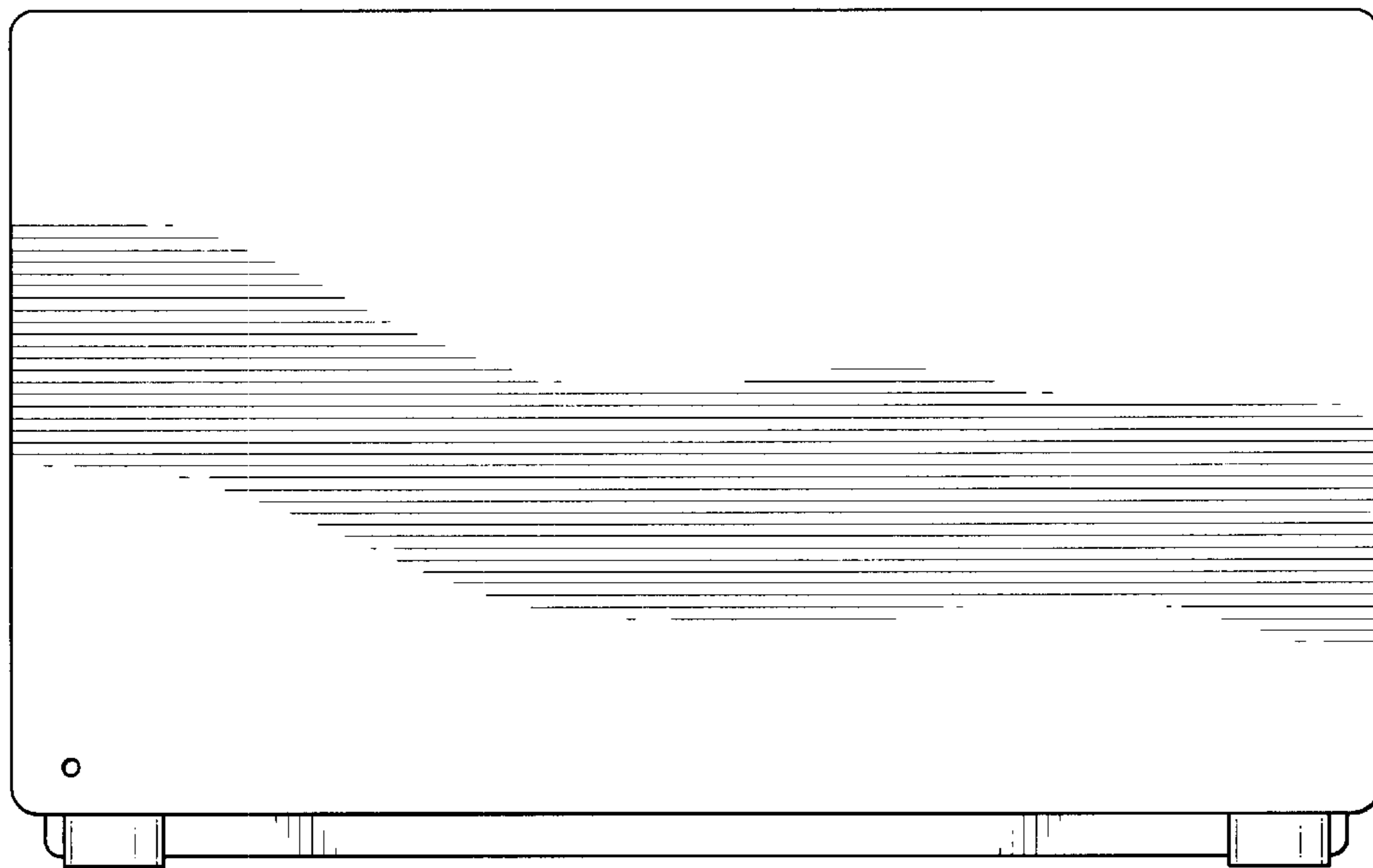

Fig. 3

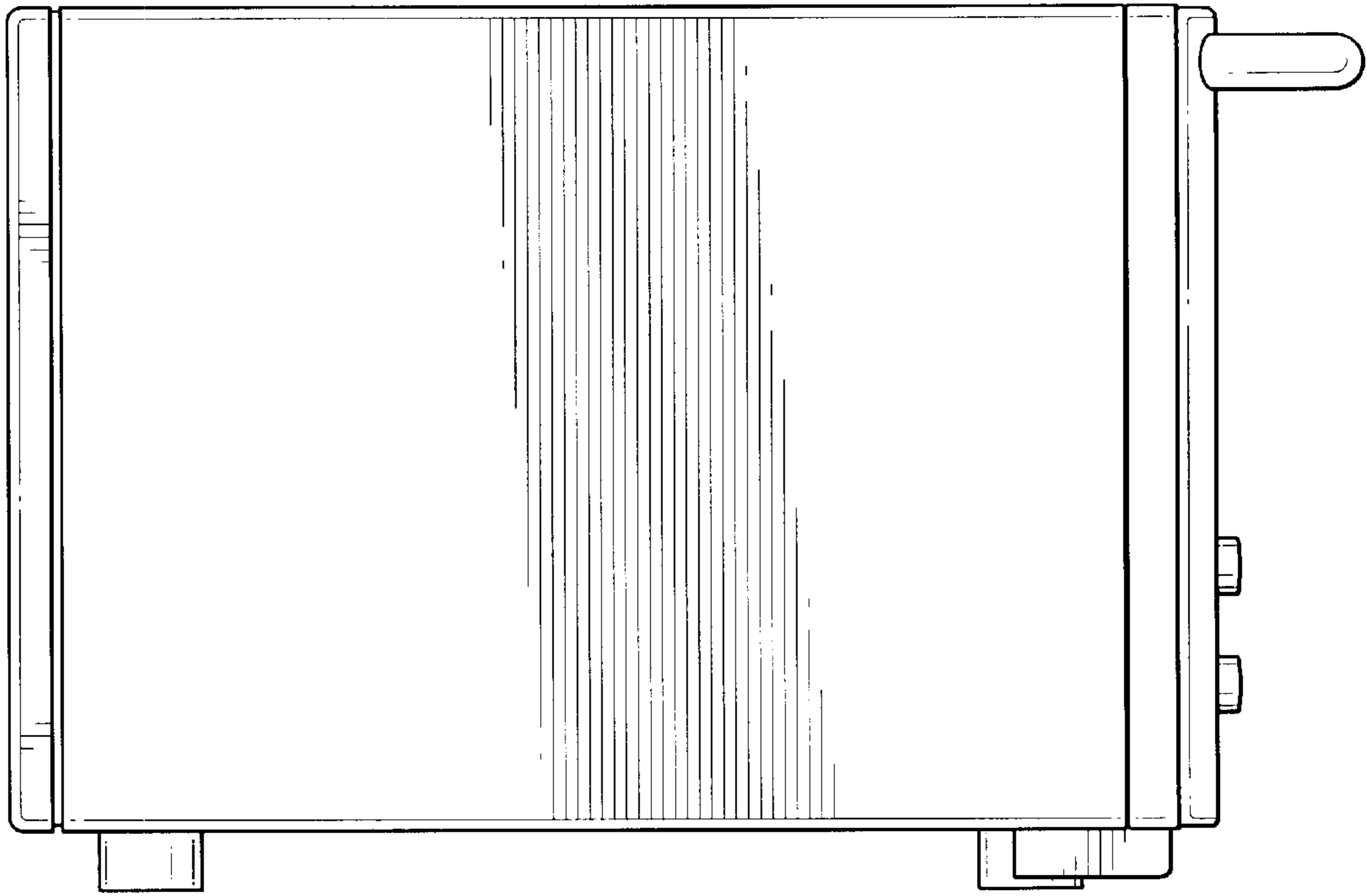

Fig. 4

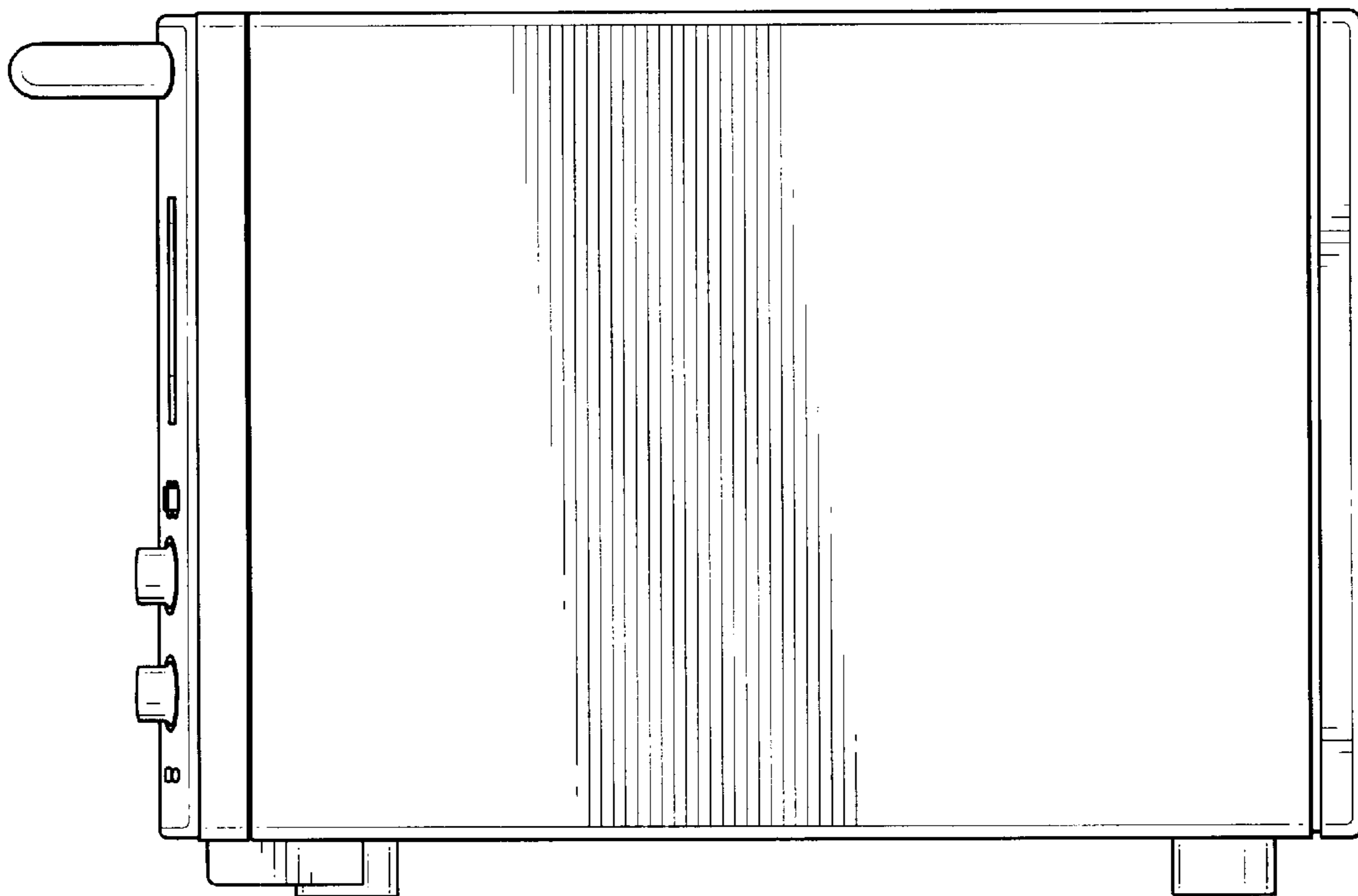

Fig. 5

Fig. 6

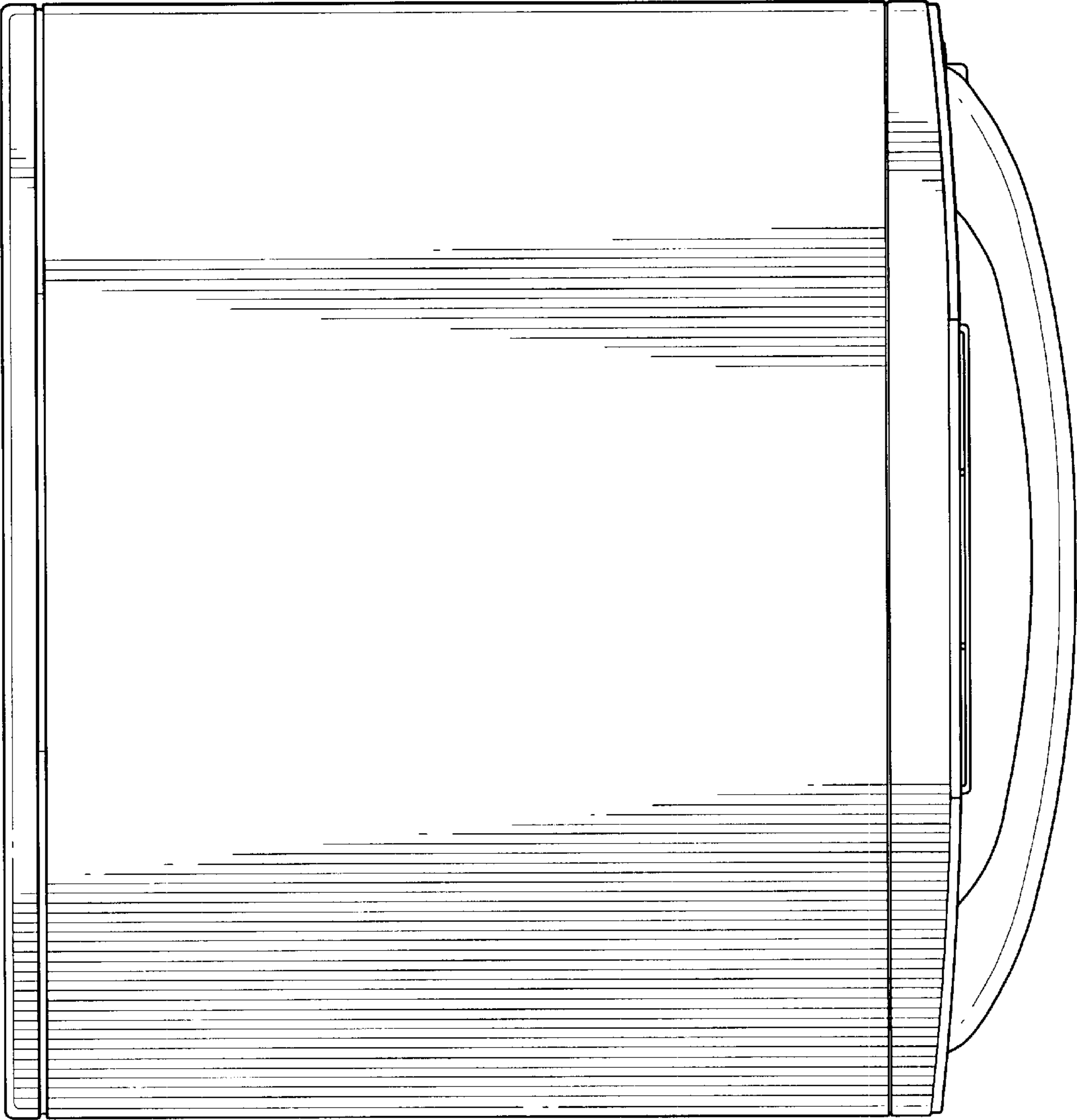

Fig. 7

