



US00D510196S

(12) **United States Design Patent**
Woodard et al.

(10) **Patent No.: US D510,196 S**
(45) **Date of Patent: ** Oct. 4, 2005**

- (54) **FRAME**
- (75) Inventors: **Rudy Woodard**, Boston, MA (US);
Joseph Geringer, Merrimack, NH (US);
Timothy L. Trzepacz, Auburn, NH (US);
Stephen R. Lyman, Hudson, NH (US)
- (73) Assignee: **Brookstone Purchasing, Inc.**,
Merrimack, NH (US)
- (**) Term: **14 Years**
- (21) Appl. No.: **29/197,113**
- (22) Filed: **Jan. 9, 2004**
- (51) **LOC (8) Cl. 06-07**
- (52) **U.S. Cl. D6/300**
- (58) **Field of Search D6/300-314, 631;**
D14/168, 336, 337, 189, 299; 40/448, 455,
774, 720-721, 906; D19/26, 28; 362/135

5,577,918 A	11/1996	Crowell	434/319
5,605,354 A	2/1997	Kwon	281/22
D379,458 S	* 5/1997	Muller et al.	D14/168
D394,874 S	* 6/1998	Aguilar	D19/28
D397,324 S	* 8/1998	Minemoto et al.	D14/337
5,954,514 A	9/1999	Haas et al.	434/317
5,979,097 A	11/1999	Moore	40/769
6,148,173 A	11/2000	Bell	434/309
6,167,233 A	12/2000	Gresser, Jr. et al.	434/308
6,363,639 B1	4/2002	Chan	40/509
6,363,402 B1	5/2002	Loudermilk et al.	704/272
6,393,401 B1	5/2002	Loudermilk et al.	704/272
6,427,370 B1	8/2002	Smith	40/717
6,446,376 B1	9/2002	Chan	40/721
6,553,704 B1	4/2003	Pigg	40/734
6,591,526 B1	7/2003	Garrett	40/455
6,640,475 B2	* 11/2003	Gravitt et al.	40/455
D487,481 S	* 3/2004	Harris et al.	D19/26

* cited by examiner

Primary Examiner—Janice E. Seeger
Assistant Examiner—Sydney R. Buffalow
(74) *Attorney, Agent, or Firm*—Nixon Peabody LLP

(56) **References Cited**

U.S. PATENT DOCUMENTS

1,068,621 A	7/1913	Abraham	
1,626,150 A	4/1927	Parda	
2,796,689 A	6/1957	Yannone	40/152.1
2,839,857 A	6/1958	Teller	40/64
3,624,939 A	12/1971	Gossard	40/10
4,443,959 A	4/1984	Ackeret	40/152
4,531,319 A	7/1985	Saxton	40/539
4,550,516 A	11/1985	Ackeret	40/513
4,854,060 A	8/1989	Corbo et al.	40/152.1
D310,919 S	* 10/1990	Sakai	D6/311
5,347,738 A	9/1994	Zweig et al.	40/642
5,387,108 A	2/1995	Crowell	434/319
5,400,532 A	3/1995	Grove	40/152.1
5,499,465 A	* 3/1996	Manico	40/717

(57) **CLAIM**

I claim the ornamental design for a frame, as shown and described.

DESCRIPTION

FIG. 1 is a front, perspective view of a frame showing our new design;
FIG. 2 is a top plan view thereof;
FIG. 3 is a bottom plan view thereof;
FIG. 4 is a right-side elevation view thereof;
FIG. 5 is a left-side elevation view thereof;
FIG. 6 is a front elevation view thereof; and,
FIG. 7 is a rear elevation view thereof.

1 Claim, 7 Drawing Sheets

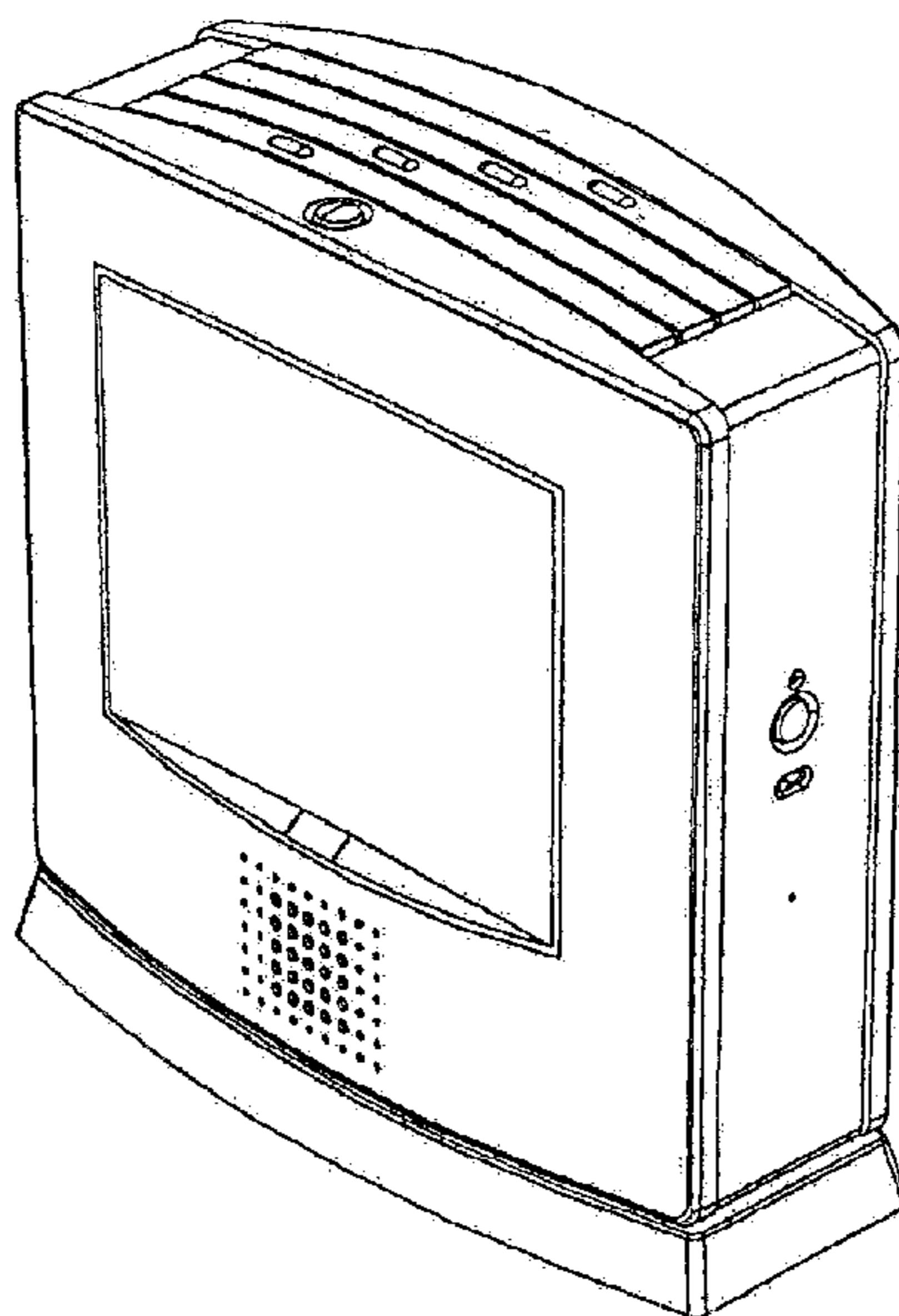

FIG. 1

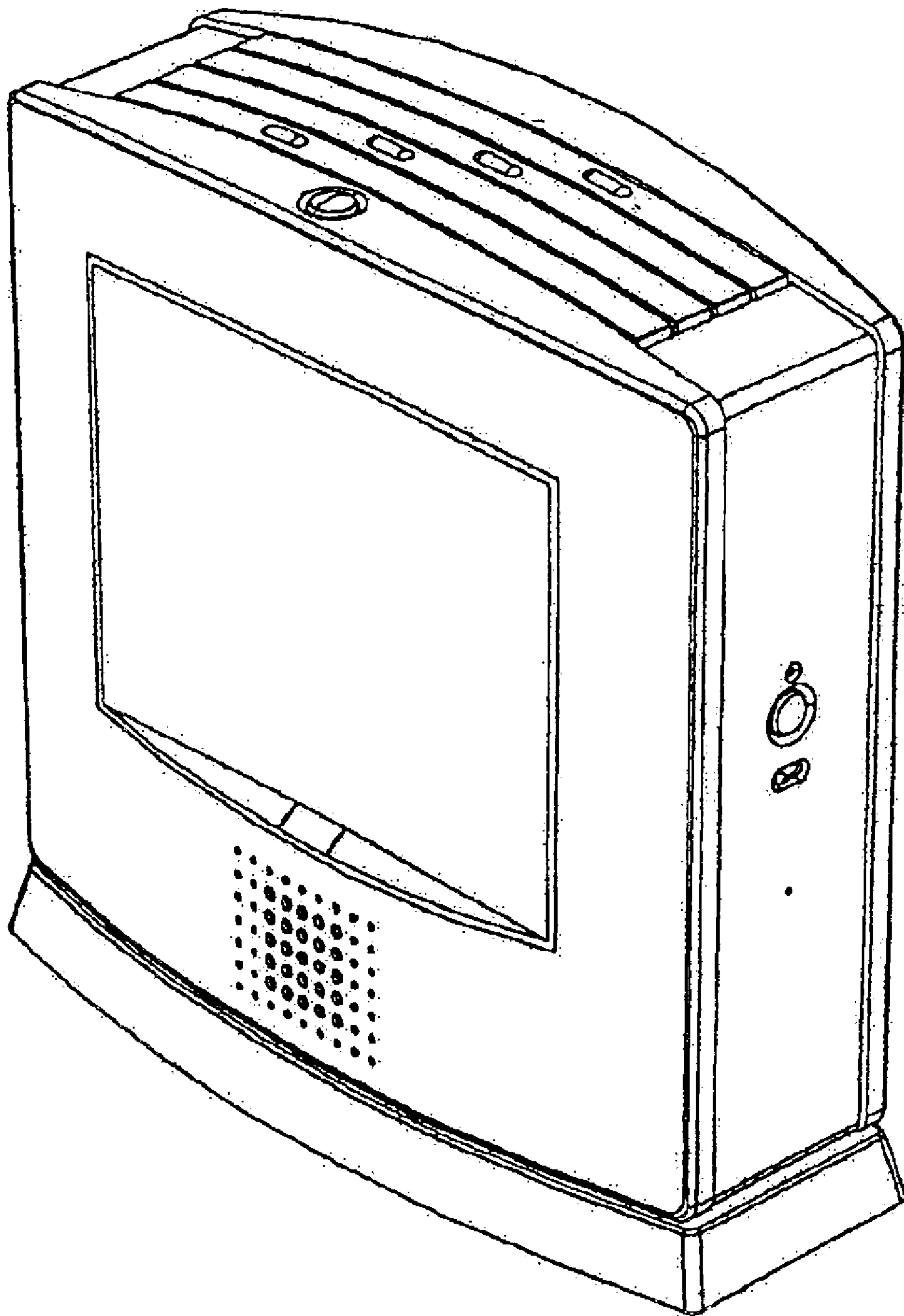

FIG. 2

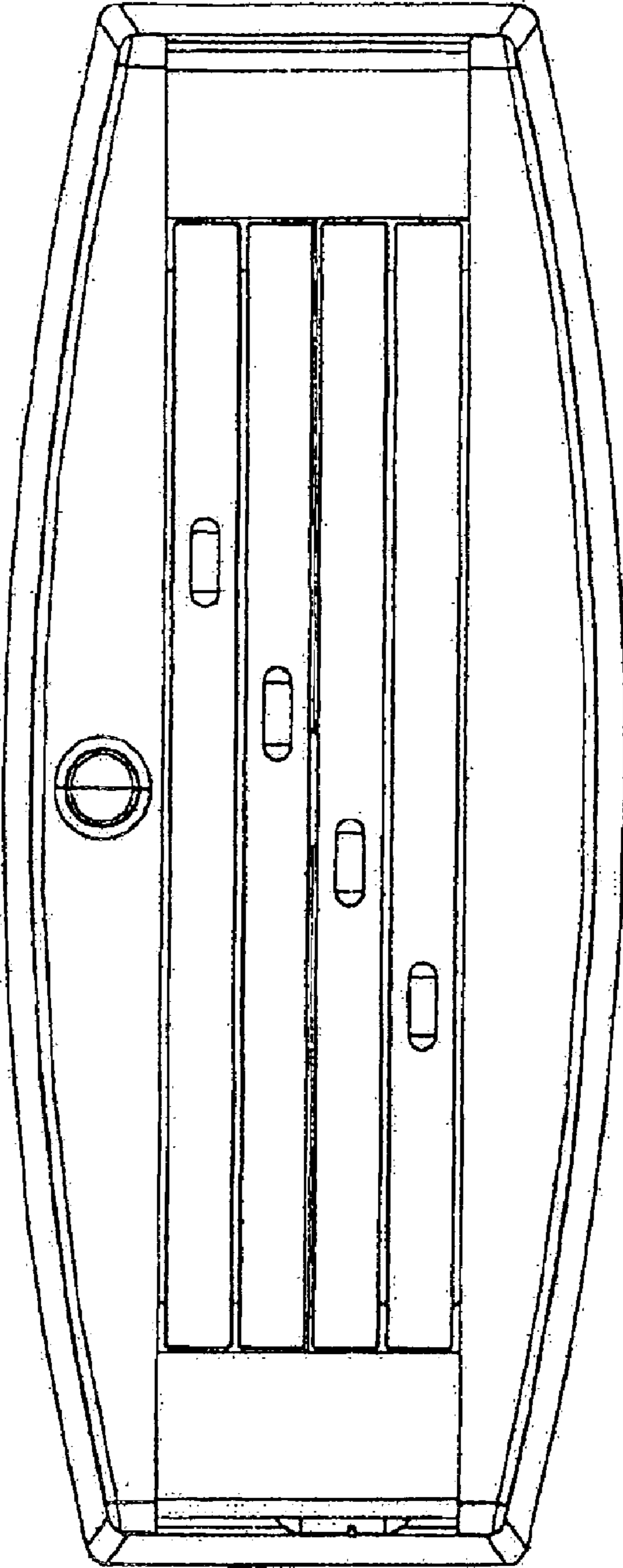

FIG. 3

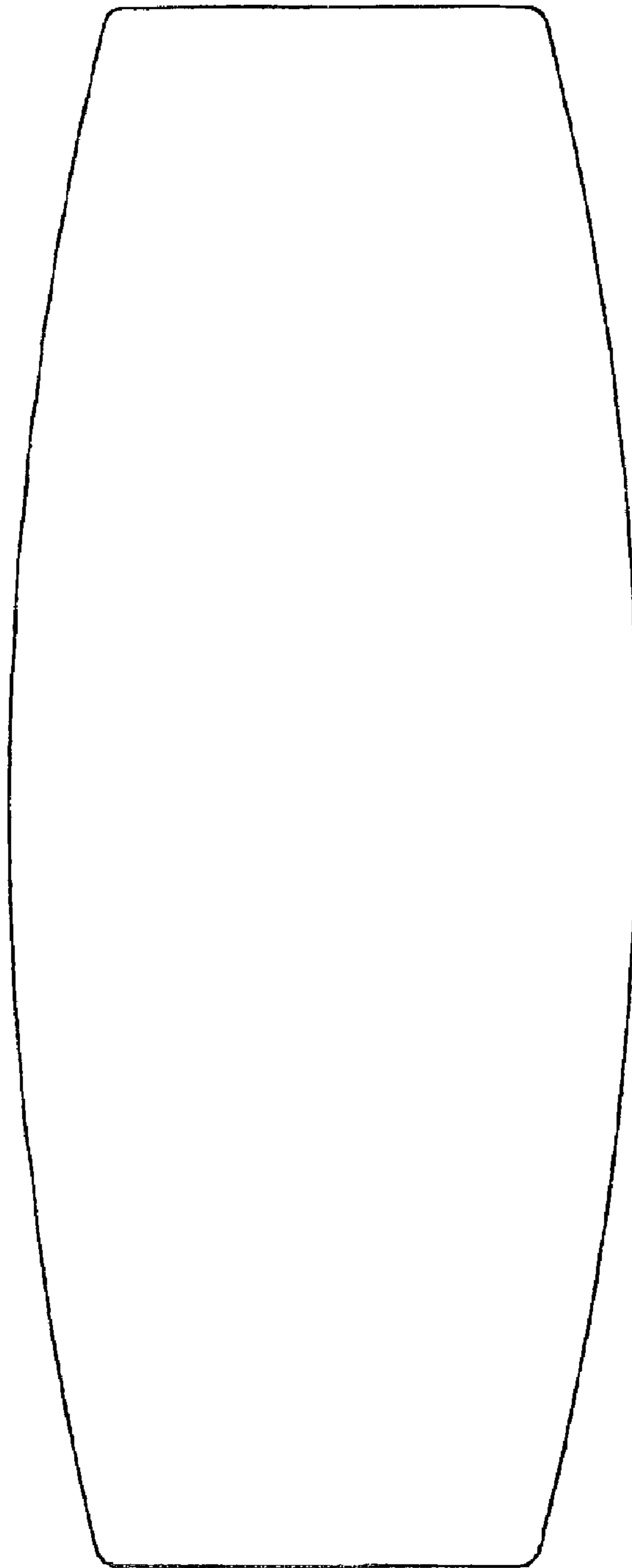

FIG. 4

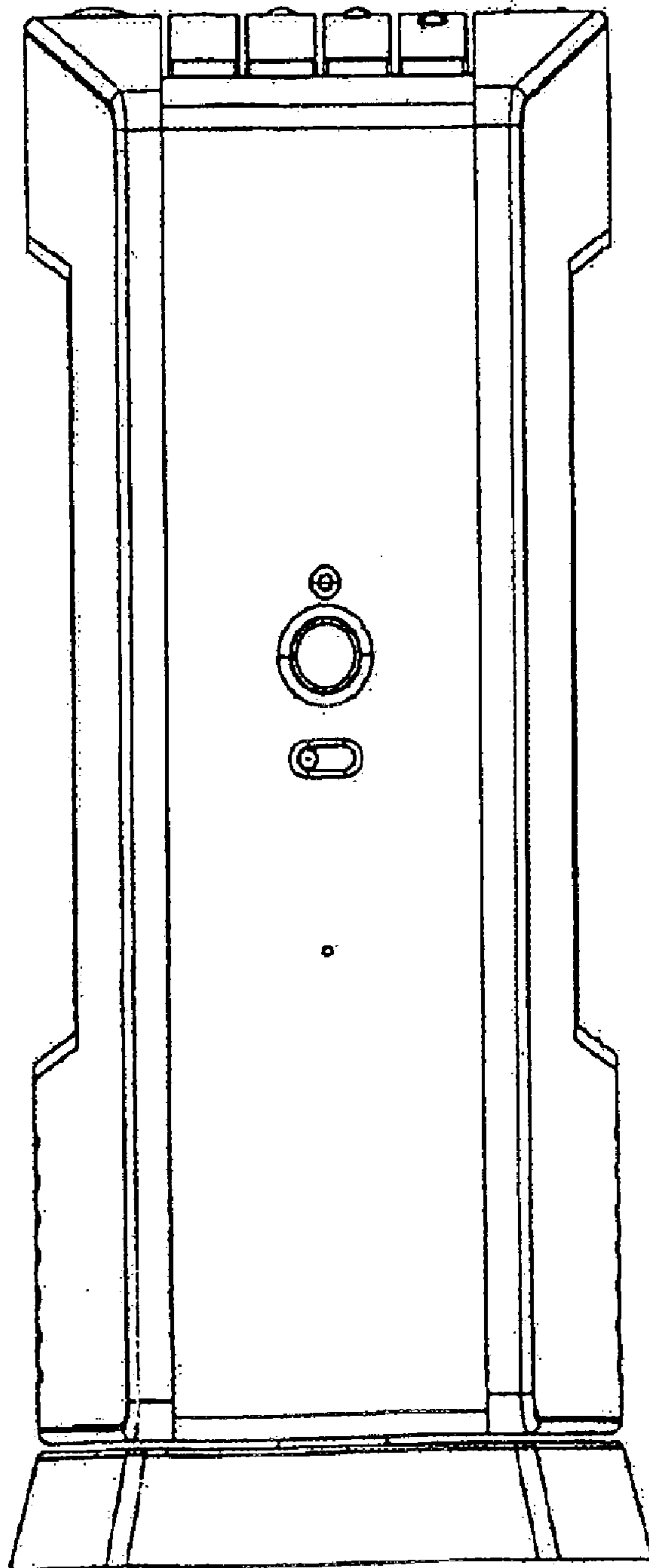

FIG. 5

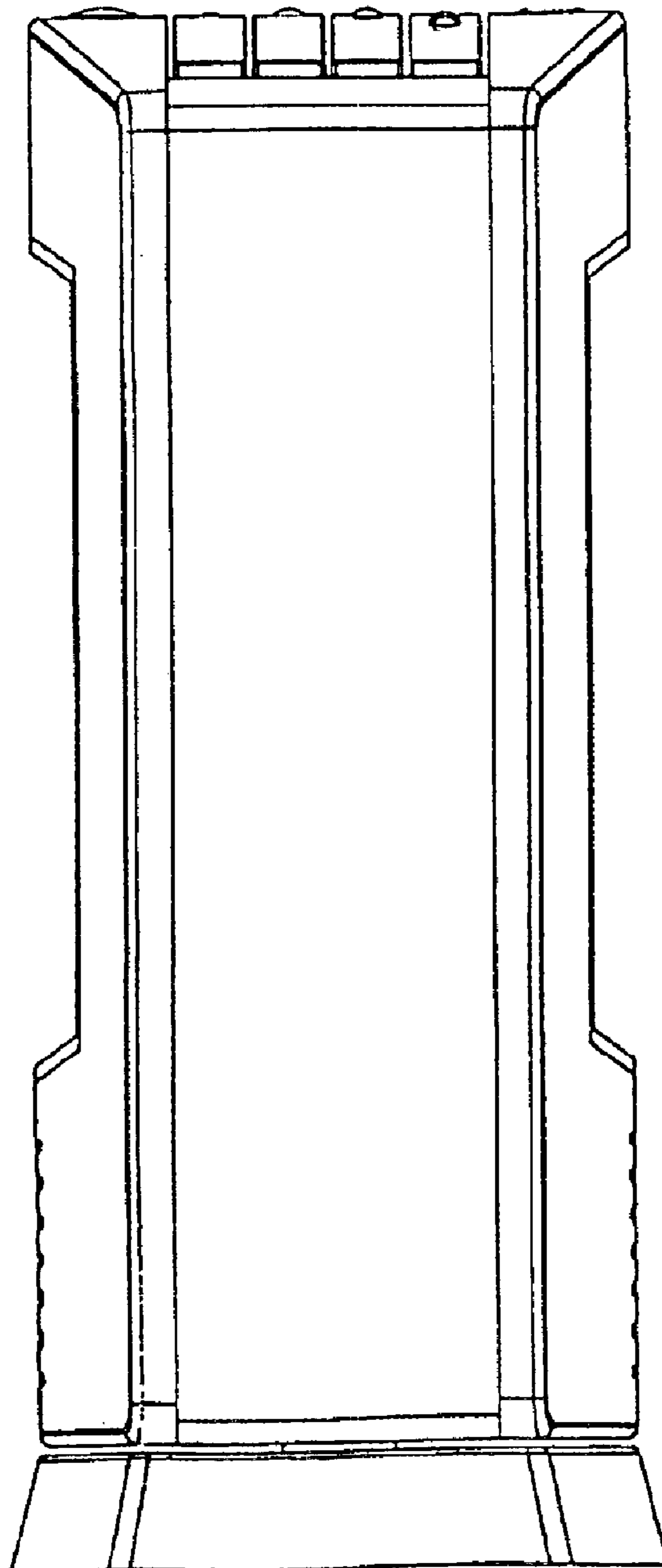

FIG. 6

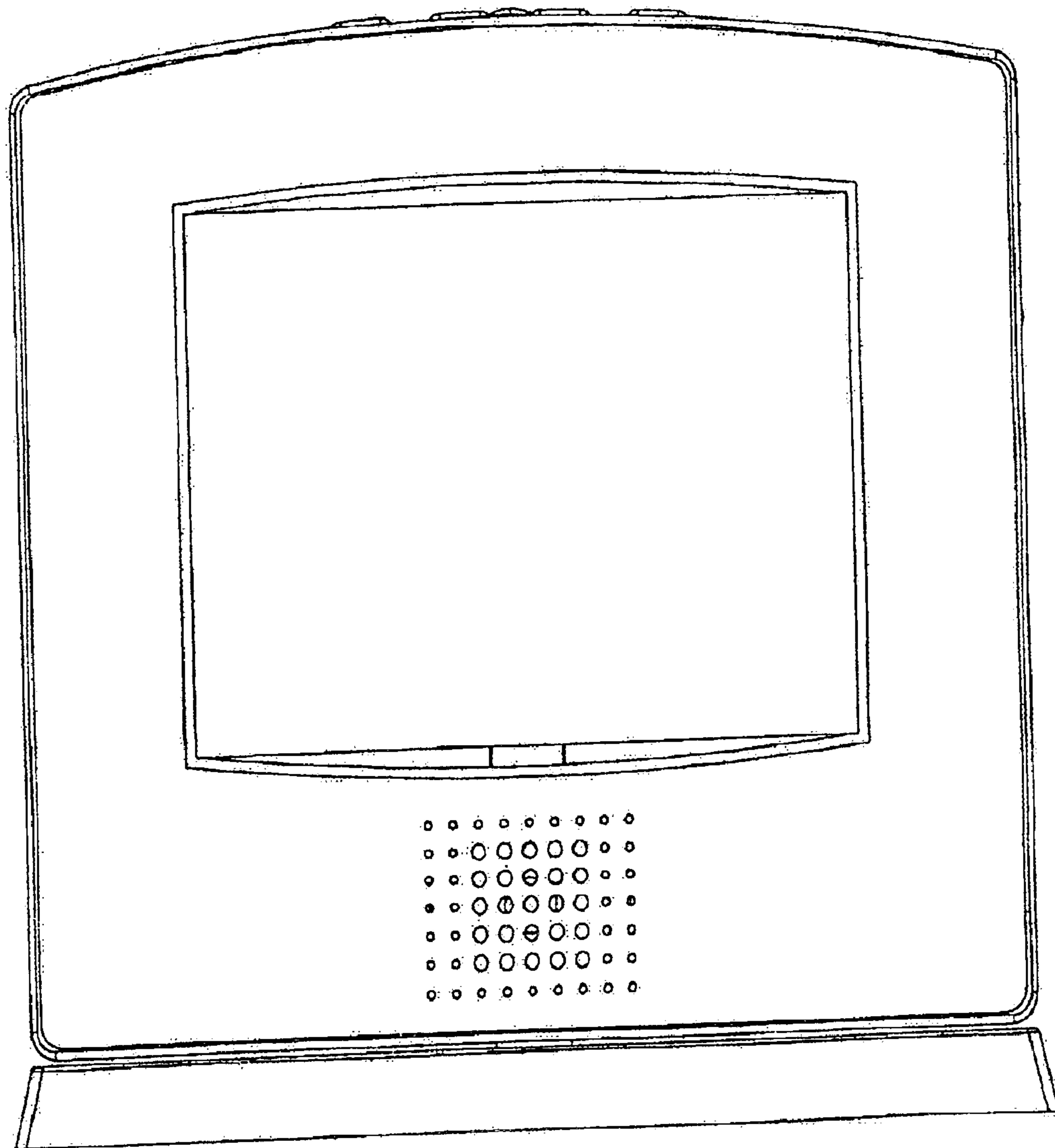

FIG. 7

