



US00D510129S

(12) **United States Design Patent**
Ouyoung

(10) **Patent No.:** **US D510,129 S**

(45) **Date of Patent:** **** Sep. 27, 2005**

(54) **ESCUTCHEON**

D478,154 S * 8/2003 Ouyoung D23/249

(75) **Inventor:** **Scott Ouyoung**, Taichung (TW)

* cited by examiner

(73) **Assignee:** **Globe Union Industrial Corp.**,
Taichung (TW)

Primary Examiner—Louis S. Zarfes

Assistant Examiner—Gregory Andoll

(74) *Attorney, Agent, or Firm*—Troxell Law Office, PLLC

(**) **Term:** **14 Years**

(57) **CLAIM**

(21) **Appl. No.:** **29/200,672**

The ornamental design for escutcheon, as show and described.

(22) **Filed:** **Mar. 4, 2004**

DESCRIPTION

(51) **LOC (8) Cl.** **23-01**

(52) **U.S. Cl.** **D23/254; D23/249**

(58) **Field of Search** **D23/238–257;**
4/675–678; 137/801

FIG. 1 is a top, left, front, perspective view of escutcheon showing my new design;

FIG. 2 is a left elevational view thereof;

FIG. 3 is a right elevational view thereof;

FIG. 4 is a rear elevational view thereof;

FIG. 5 is a front elevational view thereof;

FIG. 6 is a top plan view thereof; and,

FIG. 7 is a bottom plan view thereof.

(56) **References Cited**

U.S. PATENT DOCUMENTS

D360,679 S * 7/1995 Doughty et al. D23/241

D383,194 S * 9/1997 Doughty et al. D23/249

D413,652 S * 9/1999 Ko D23/242

1 Claim, 4 Drawing Sheets

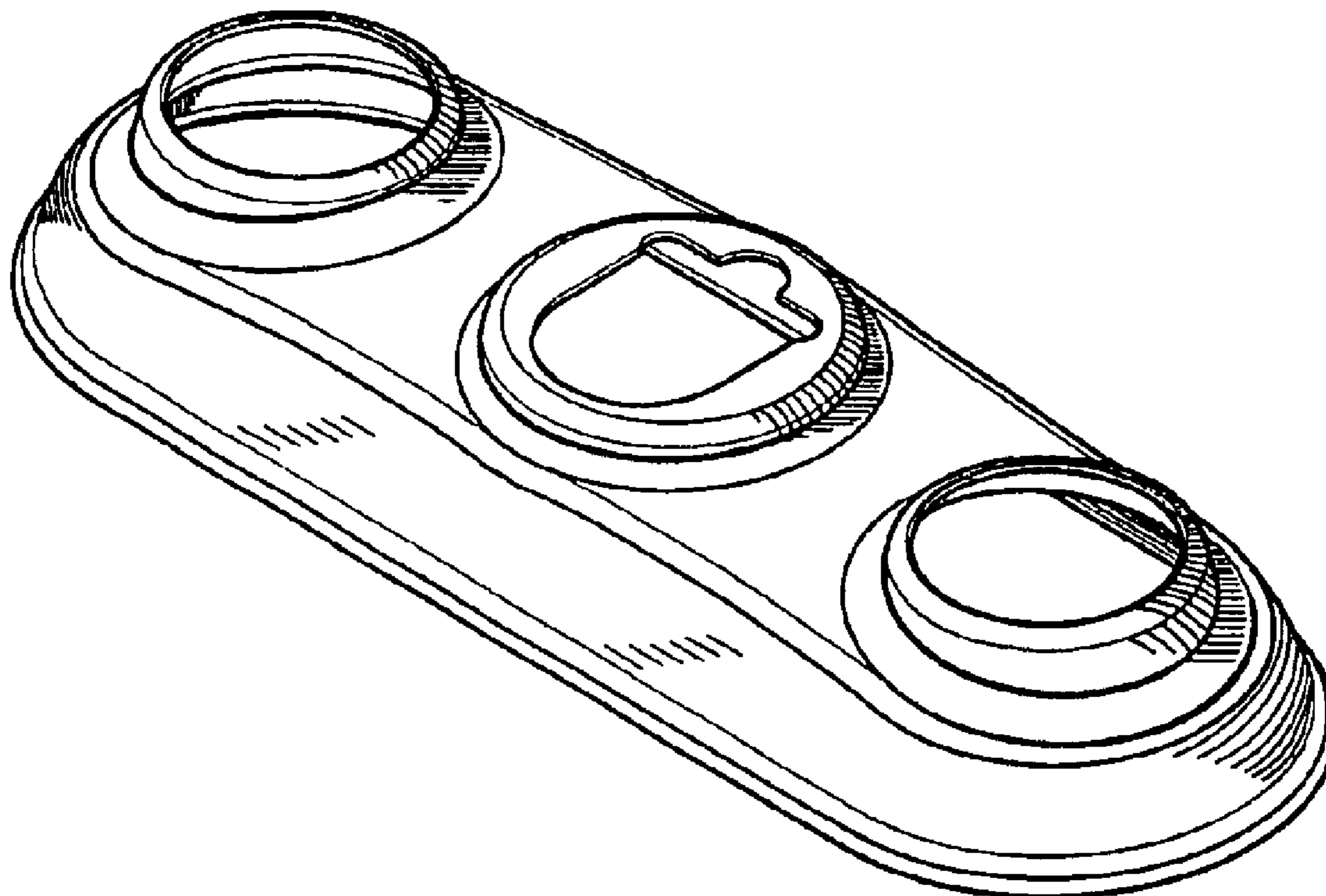

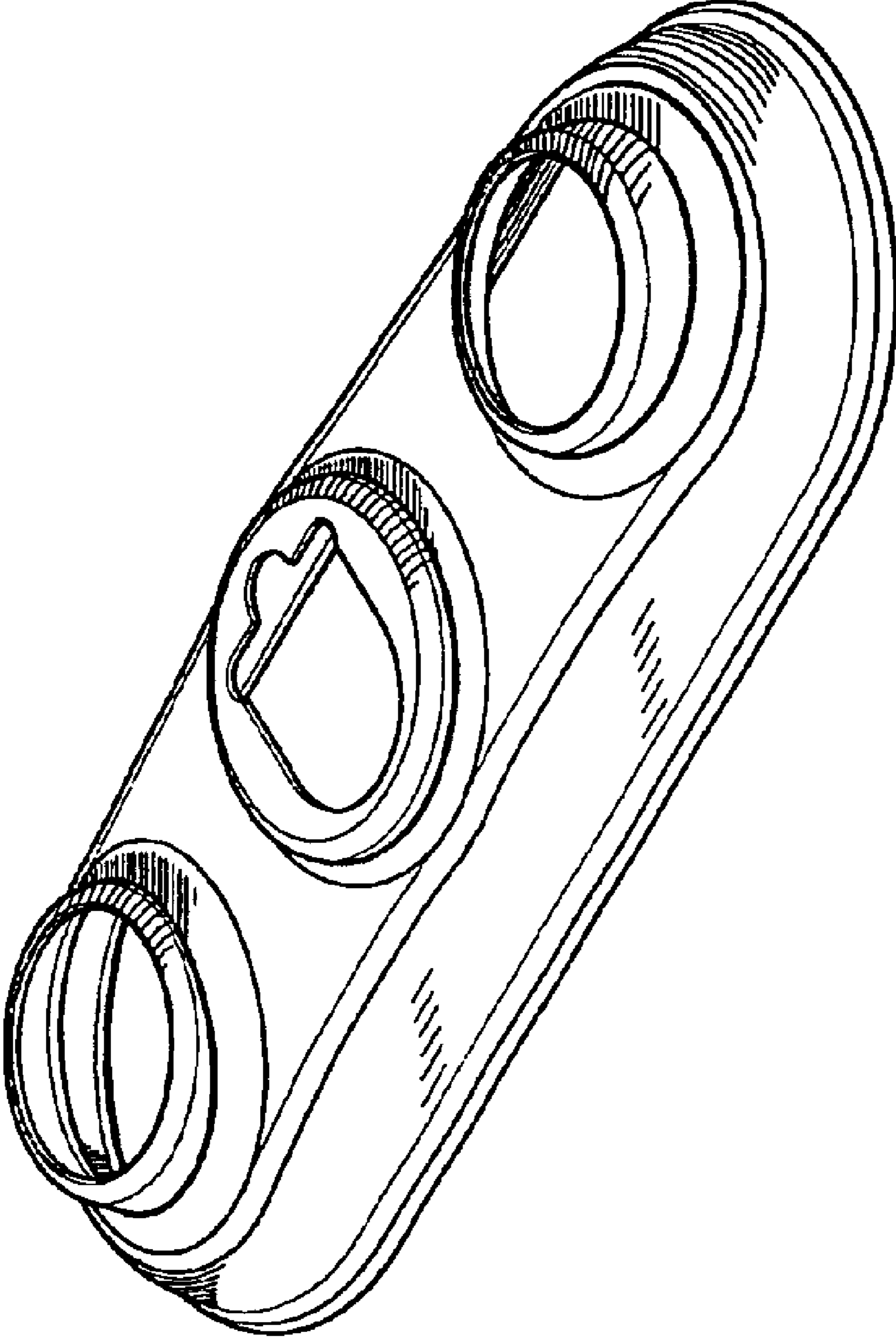

FIG. 1

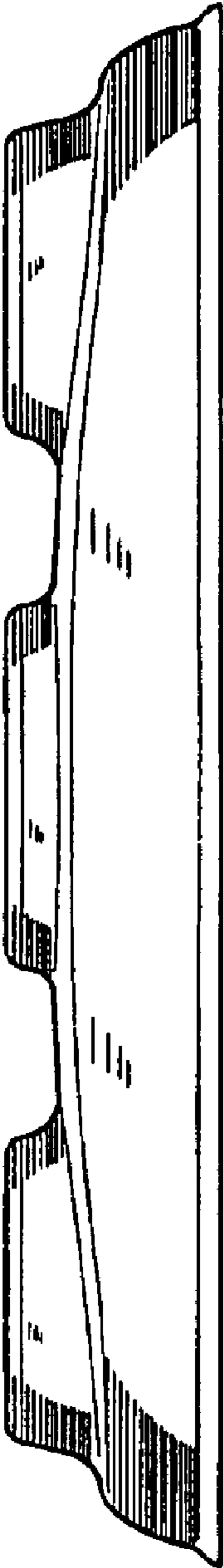

FIG. 2

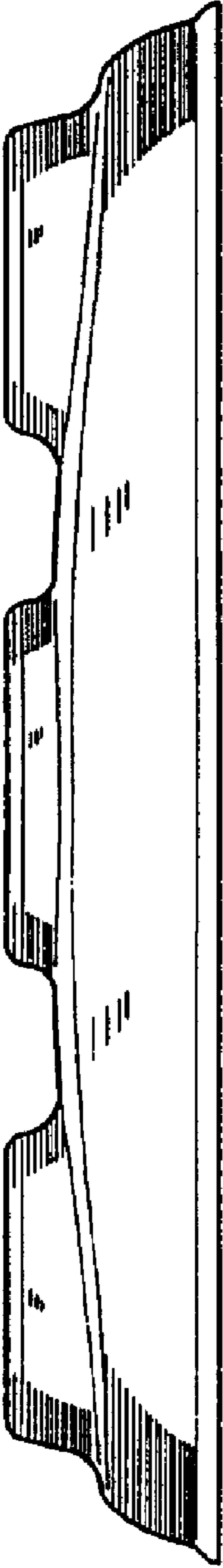

FIG. 3

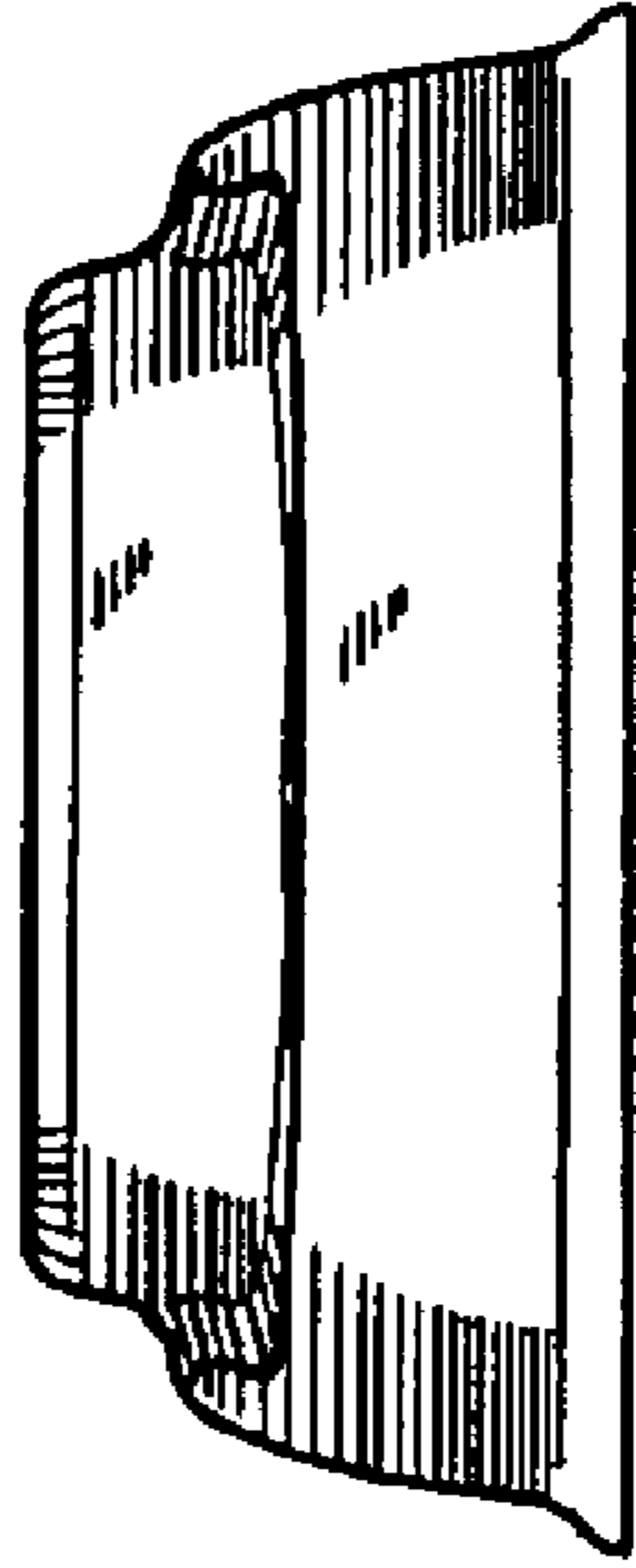

FIG. 5

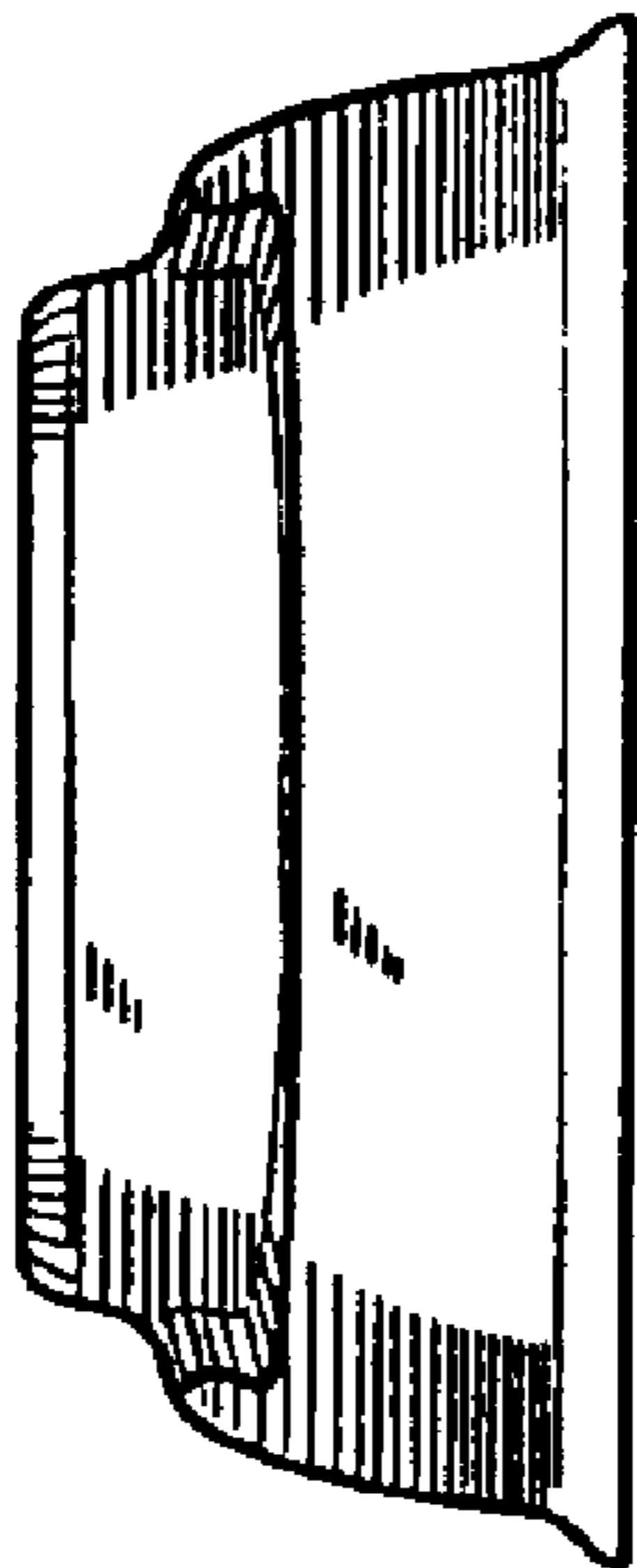

FIG. 4

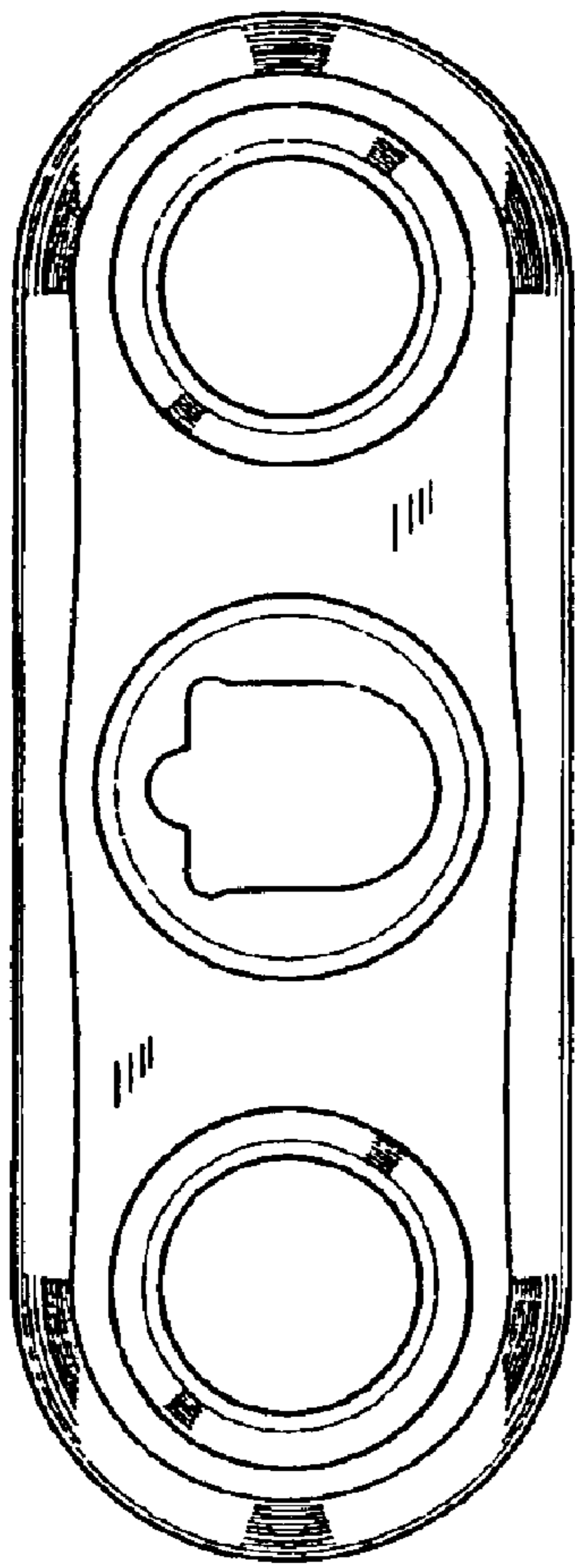

FIG. 6

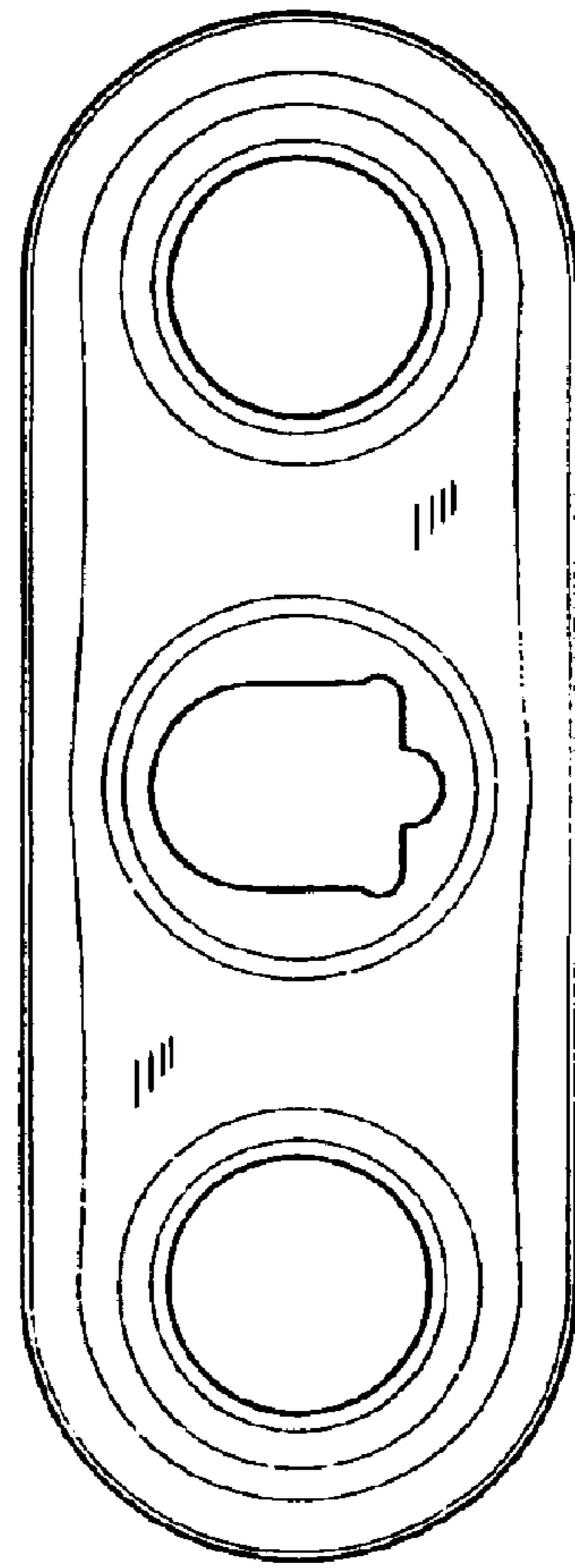

FIG. 7