



US00D510121S

(12) **United States Design Patent** (10) **Patent No.:** **US D510,121 S**
Blair (45) **Date of Patent:** **** Sep. 27, 2005**

(54) **NEKODE CLAWS**

(76) **Inventor:** **Titus Blair**, 2015 Westwind Dr., Suite 1, Bakersfield, CA (US) 93301

(**) **Term:** **14 Years**

(21) **Appl. No.:** **29/191,183**

(22) **Filed:** **Oct. 1, 2003**

(51) **LOC (8) Cl.** **22-02**

(52) **U.S. Cl.** **D22/117; D22/199**

(58) **Field of Search** **D22/117-118; D21/483, 658; 446/268, 26, 390, 487; 30/287, 294-295**

(56) **References Cited**

U.S. PATENT DOCUMENTS

4,543,721 A	*	10/1985	Smith	30/287
D354,098 S	*	1/1995	Lee et al.	D21/658
D371,396 S	*	7/1996	Lee et al.	D21/420

* cited by examiner

Primary Examiner—Catherine R. Oliver

(74) *Attorney, Agent, or Firm*—James M. Duncan

(57) **CLAIM**

The ornamental design for a nekode claws, as shown and described.

DESCRIPTION

FIG. 1 is a side view of a nekode claws showing my new design, the other side being a mirror image thereof.

FIG. 2 is a top view thereof.

FIG. 3 is a front view thereof.

FIG. 4 is a first perspective view, looking from the top.

FIG. 5 is a second perspective view, looking from the bottom.

FIG. 6 is an exploded perspective view, looking from the top; and,

FIG. 7 is an exploded perspective view, looking from the bottom.

1 Claim, 3 Drawing Sheets

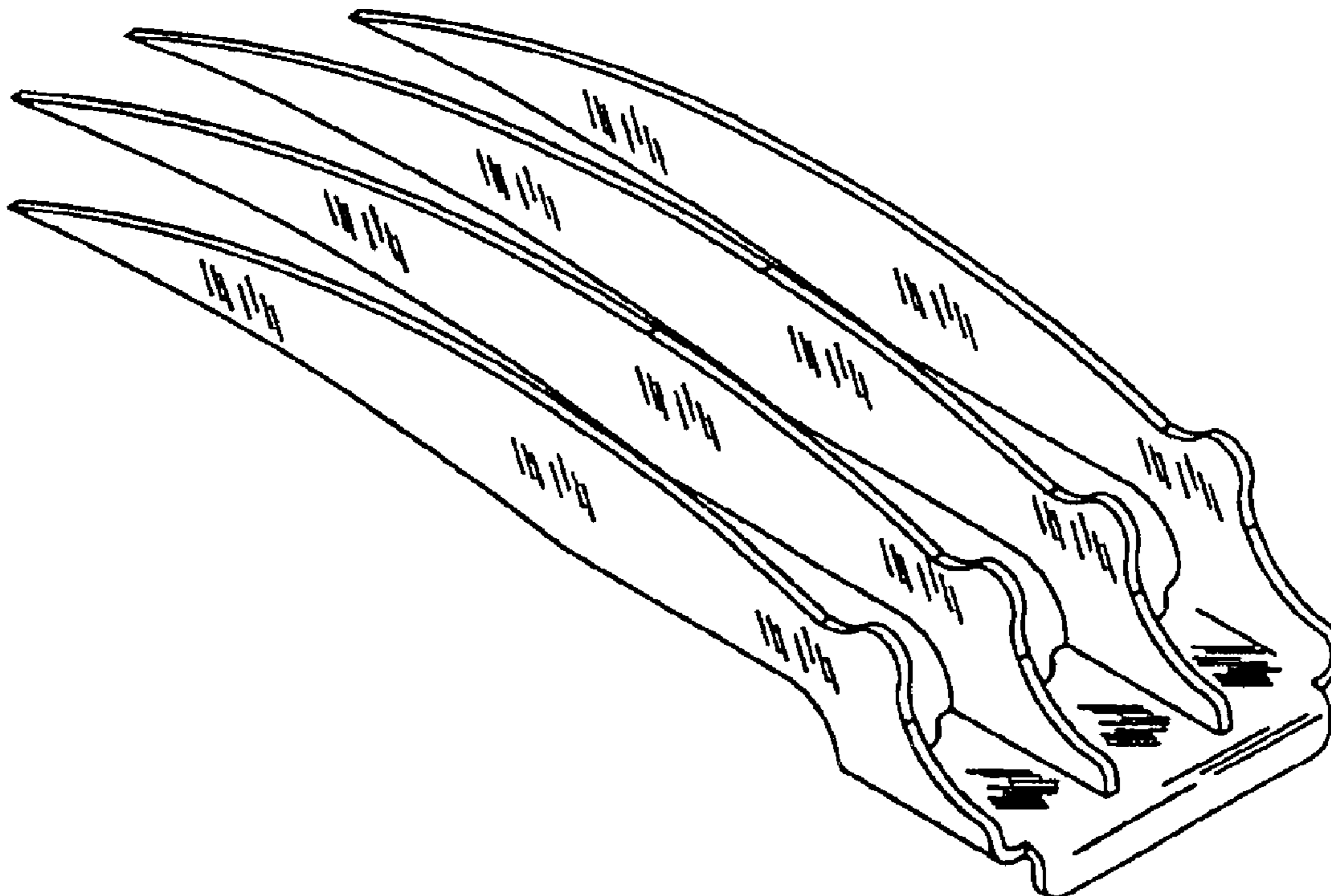

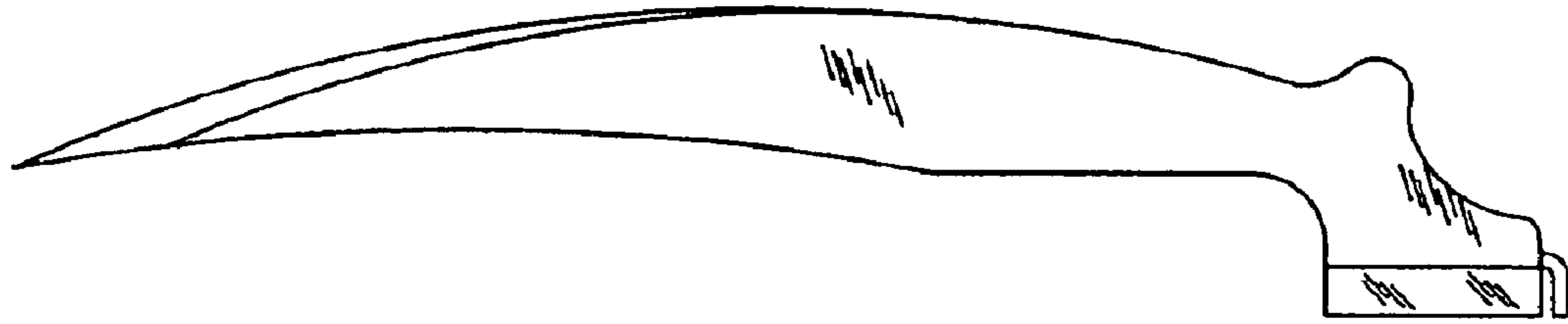

Fig. 1

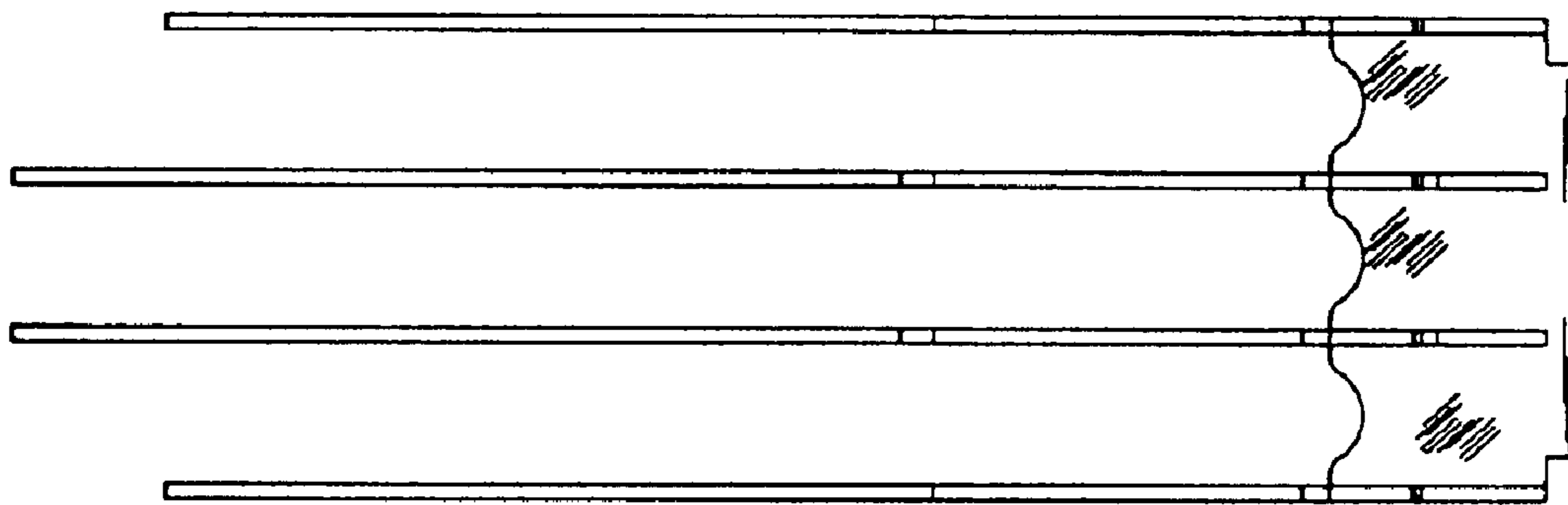

Fig. 2

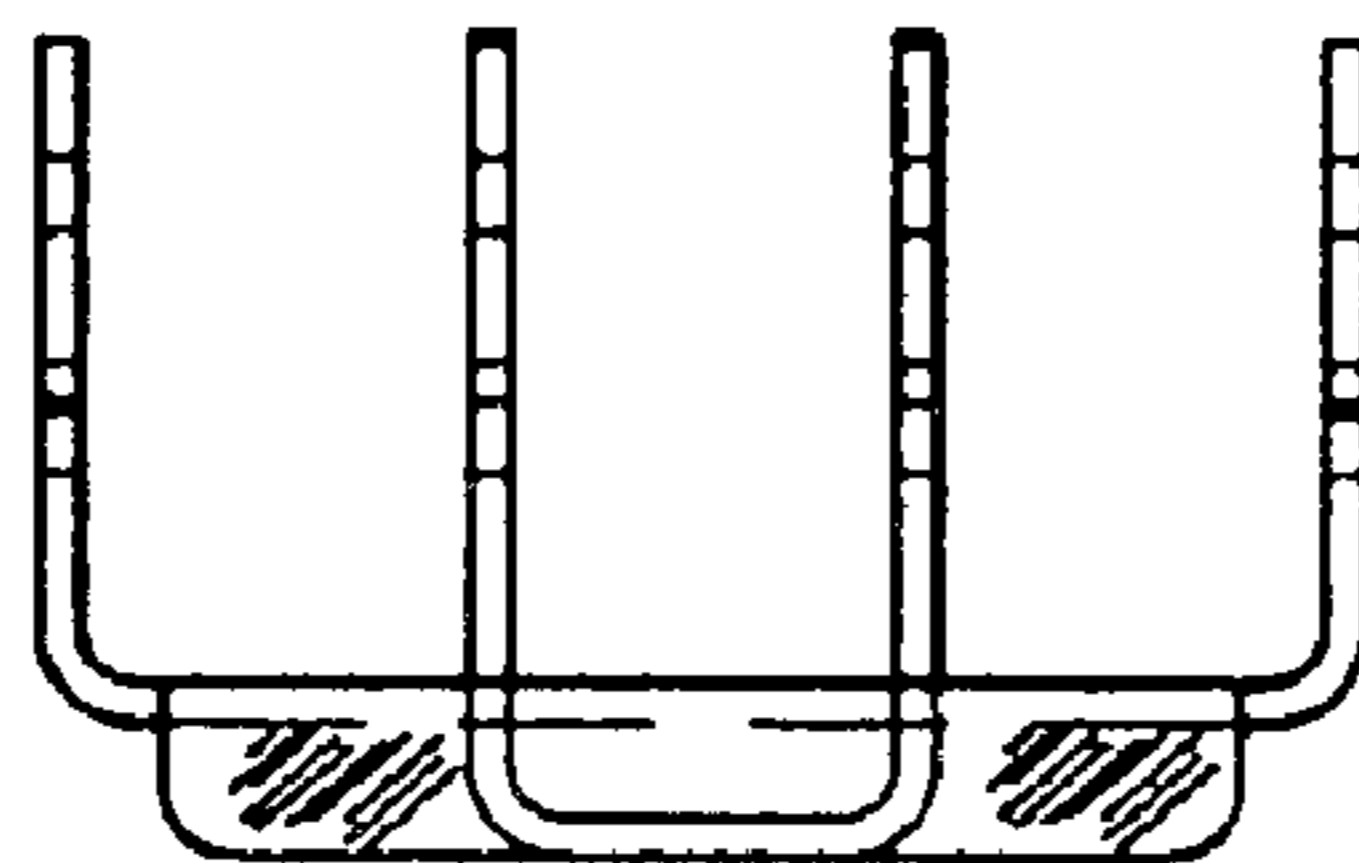

Fig. 3

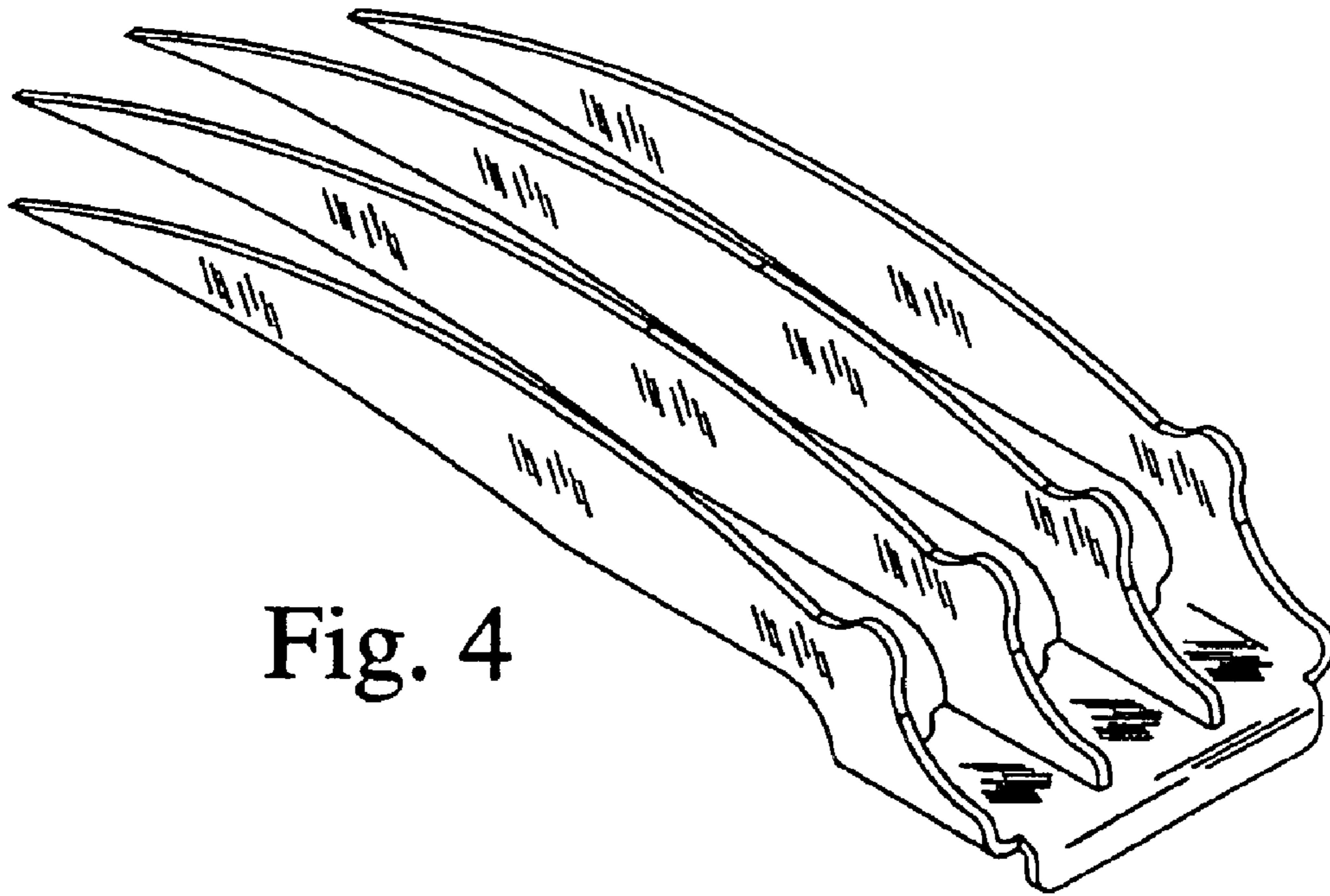

Fig. 4

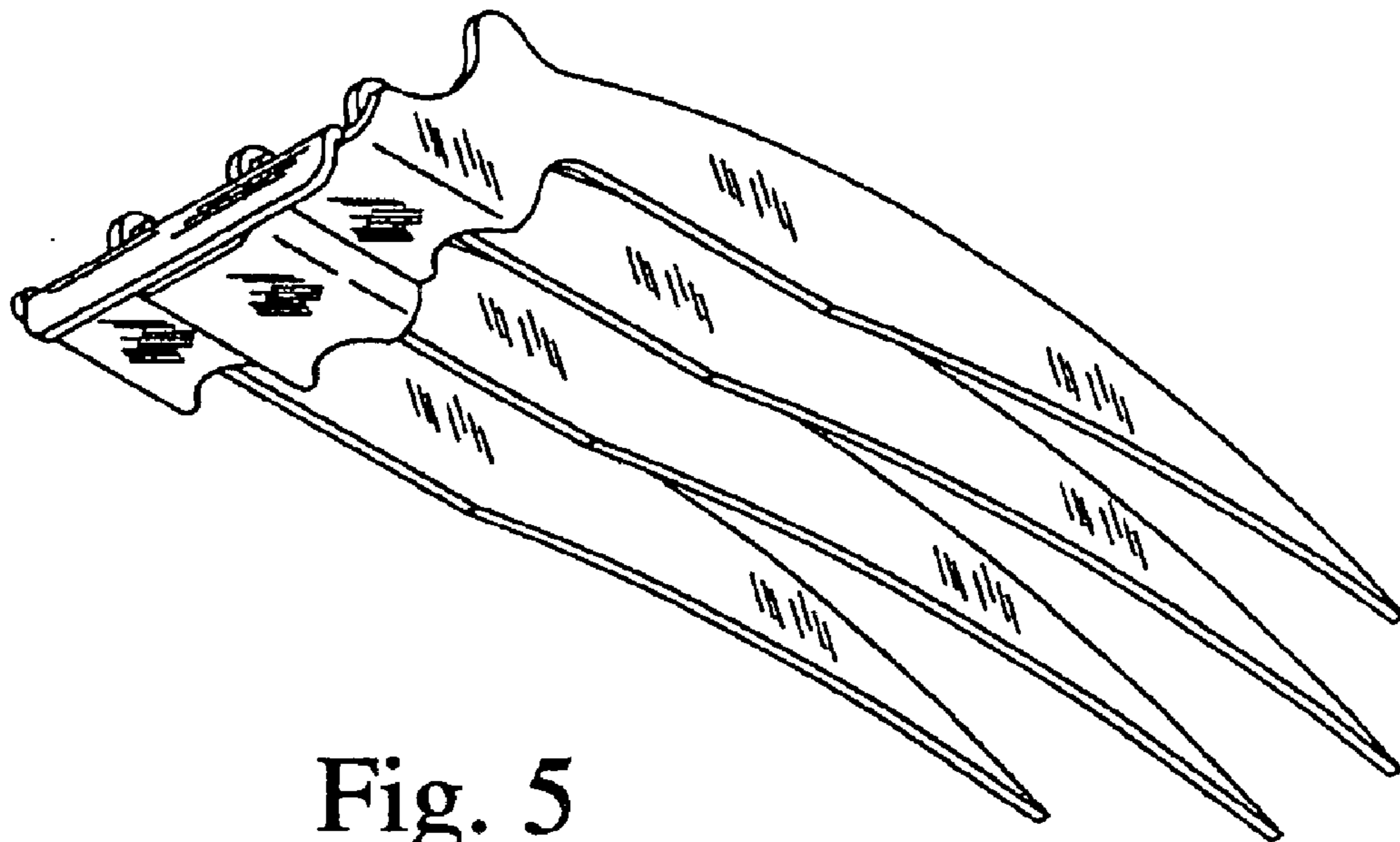

Fig. 5

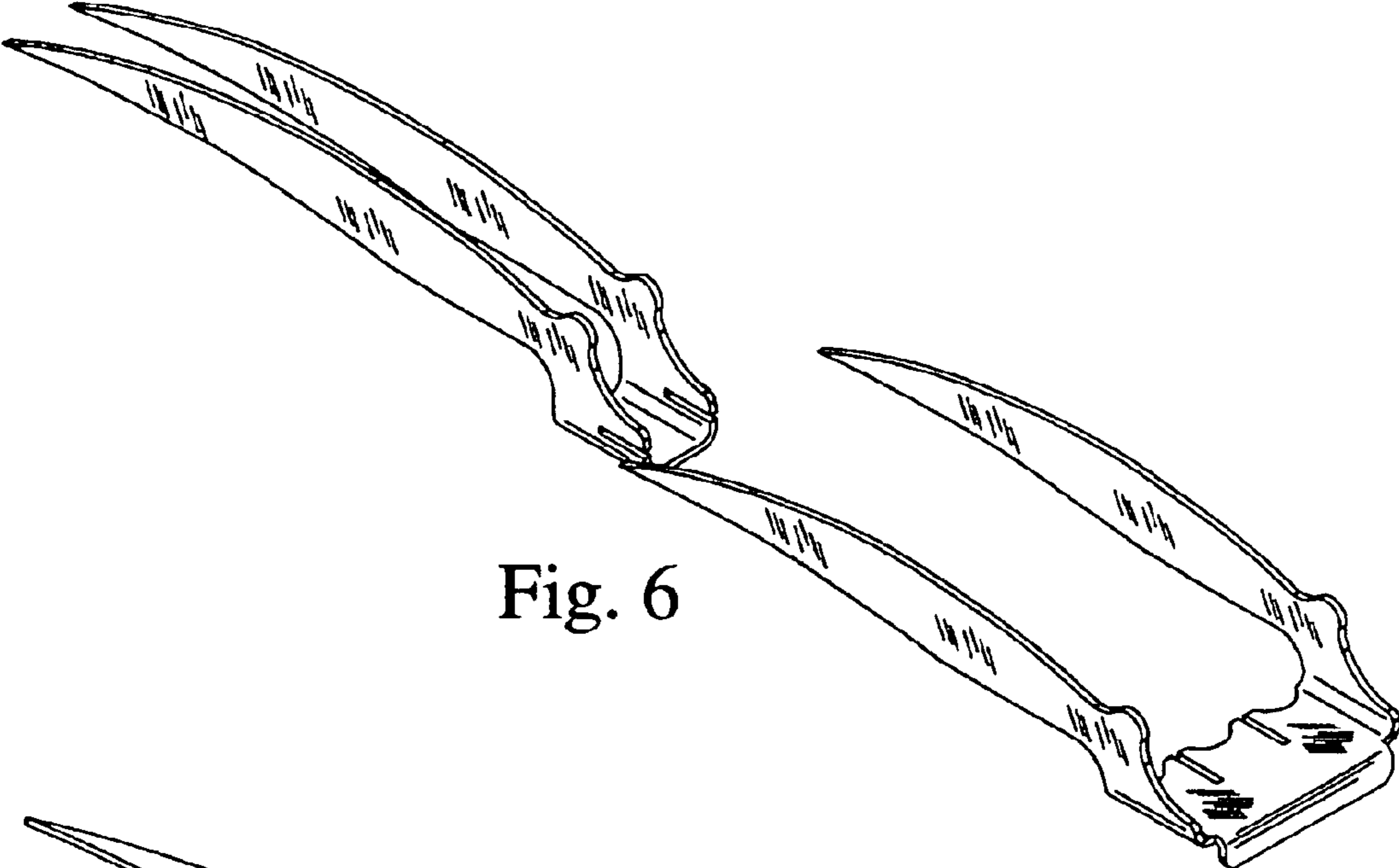

Fig. 6

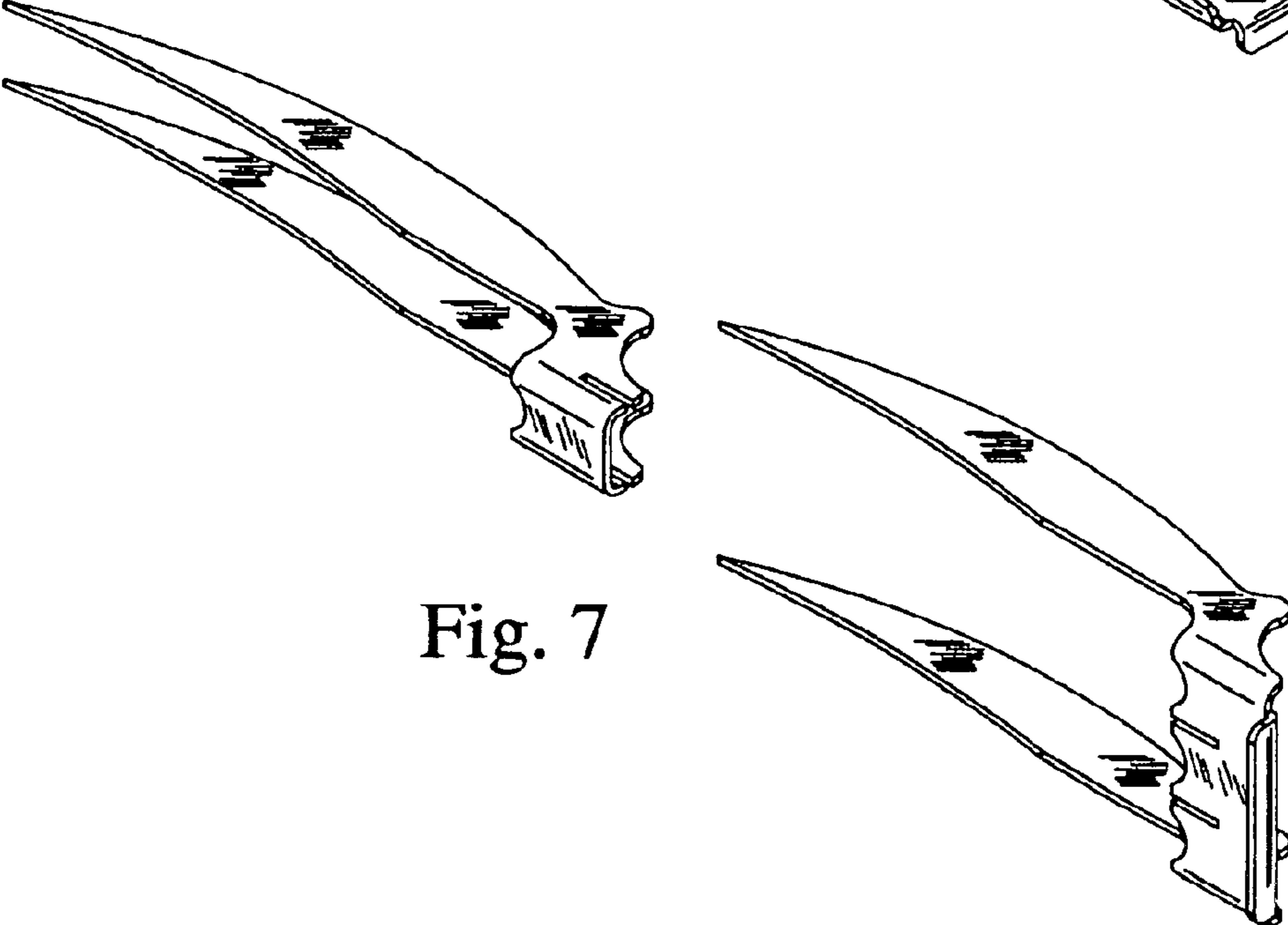

Fig. 7