



US00D510079S

(12) **United States Design Patent** (10) **Patent No.:** **US D510,079 S**
Kim et al. (45) **Date of Patent:** **** Sep. 27, 2005**

(54) **CELLULAR PHONE**

(75) Inventors: **Ki-Sung Kim**, Seoul (KR);
Chang-Hwan Hwang, Goyang-si (KR);
Yoon-Young Cho, Seoul (KR)

(73) Assignee: **Samsung Electronics Co., Ltd.** (KR)

(**) Term: **14 Years**

(21) Appl. No.: **29/217,181**

(22) Filed: **Nov. 15, 2004**

(30) **Foreign Application Priority Data**

May 27, 2004 (KR) 30-2004-0015639

(51) **LOC (8) Cl.** **14-03**

(52) **U.S. Cl.** **D14/138**

(58) **Field of Search** D14/137, 138,
D14/147-148, 247-248, 144, 341-347;
379/433.01-433.13, 434; 455/550.1-90.3,
575.3, 566, 575.1; D21/517; 345/169

(56) **References Cited**

U.S. PATENT DOCUMENTS

D405,081 S	*	2/1999	Nagele et al.	D14/138
D435,837 S	*	1/2001	Suzuki et al.	D14/138
D449,605 S	*	10/2001	Schebesch et al.	D14/345
D485,248 S	*	1/2004	Ogawa	D14/138
D485,249 S	*	1/2004	Liao et al.	D14/138
D485,818 S	*	1/2004	Yabe et al.	D14/138
D485,819 S	*	1/2004	Ahlgren	D14/138
D486,809 S	*	2/2004	Hwang	D14/138
D487,444 S	*	3/2004	Yoon	D14/138
D489,699 S	*	5/2004	Hwang et al.	D14/138
D490,065 S	*	5/2004	Shimazu et al.	D14/138
D491,547 S	*	6/2004	Cho	D14/138
D492,276 S	*	6/2004	Walliser et al.	D14/138
D496,020 S	*	9/2004	Lee	D14/138
D497,893 S	*	11/2004	Hwang et al.	D14/138
D500,016 S	*	12/2004	Kim	D14/138
D500,481 S	*	1/2005	Kim et al.	D14/138
D501,457 S	*	2/2005	Lee et al.	D14/138
D501,658 S	*	2/2005	Park et al.	D14/138

D501,839 S	*	2/2005	Lee et al.	D14/138
D502,457 S	*	3/2005	Eigenstetter et al.	D14/138
D502,458 S	*	3/2005	Chung et al.	D14/138
D502,459 S	*	3/2005	Lee et al.	D14/138
D503,697 S	*	4/2005	Kim	D14/138
2002/0022503 A1	*	2/2002	Lee	455/566
2002/0051060 A1	*	5/2002	Wada	348/207
2002/0068601 A1	*	6/2002	Lindell	455/550
2003/0125079 A1	*	7/2003	Park et al.	455/556
2004/0077384 A1	*	4/2004	Makino et al.	455/575.1
2004/0097262 A1	*	5/2004	Lee	455/556.1
2004/0102225 A1	*	5/2004	Furuta et al.	455/566
2004/0106439 A1	*	6/2004	Garroch	455/566
2004/0198458 A1	*	10/2004	Kawamura	455/566
2004/0214619 A1	*	10/2004	Chiang	455/575.3
2004/0248625 A1	*	12/2004	Yoshida et al.	455/575.1
2005/0003852 A1	*	1/2005	Song	455/550.1

FOREIGN PATENT DOCUMENTS

JP	1140985	*	5/2002
JP	D1188710	*	10/2003
WO	DM/064560	*	10/2003

* cited by examiner

Primary Examiner—Jeffrey Asch

(74) *Attorney, Agent, or Firm*—Cantor Colburn LLP

(57) **CLAIM**

The ornamental design for a cellular phone, as shown and described.

DESCRIPTION

FIG. 1 is a top and front perspective view of a cellular phone, showing our new design;
FIG. 2 is a front elevational view thereof;
FIG. 3 is a rear elevational view thereof;
FIG. 4 is a left side elevational view thereof;
FIG. 5 is a right side elevational view thereof;
FIG. 6 is a top elevational view thereof;
FIG. 7 is a bottom elevational view thereof; and,
FIG. 8 is a front perspective view thereof, the cellular phone being in an alternate position.

1 Claim, 3 Drawing Sheets

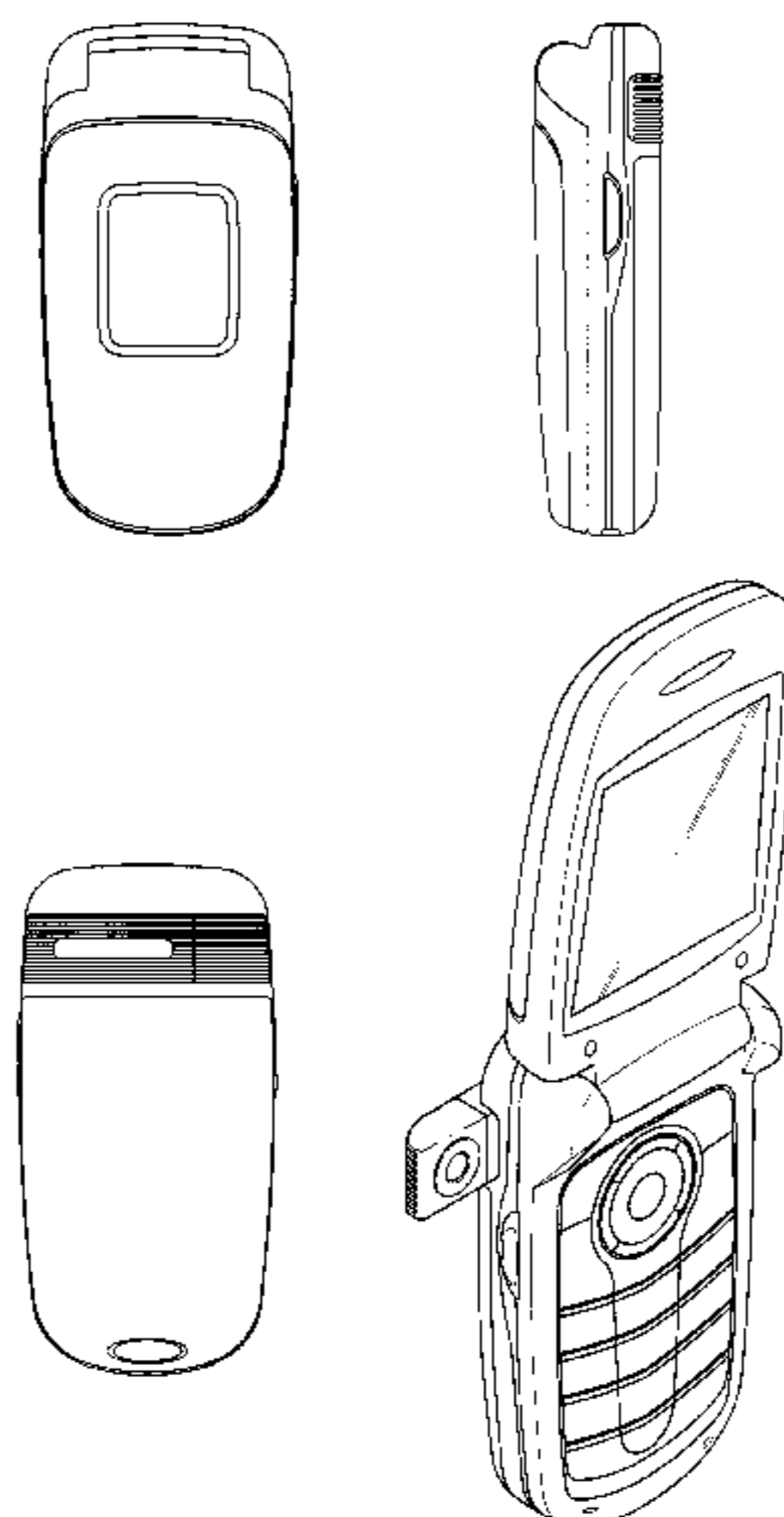

FIG. 1

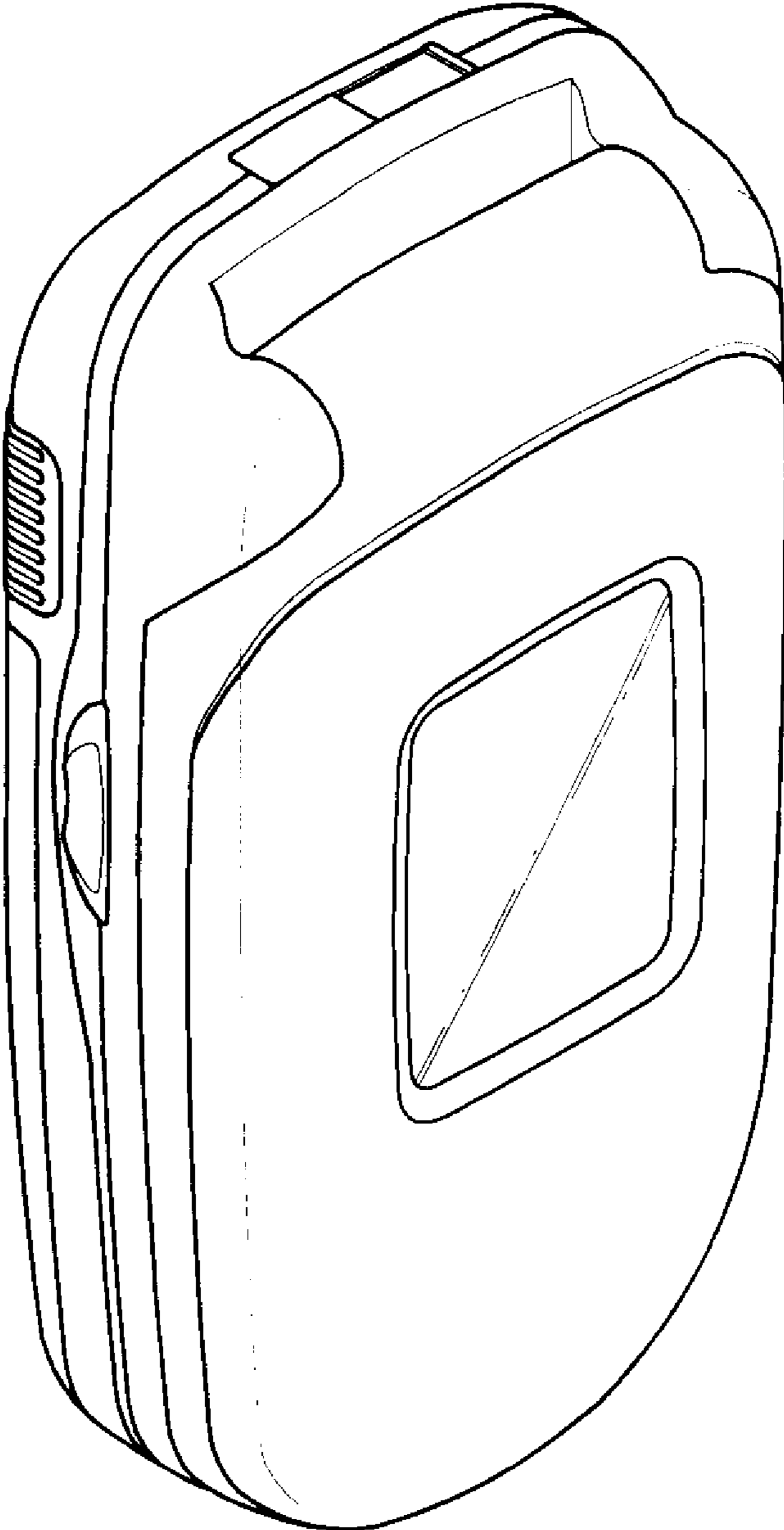

FIG. 2

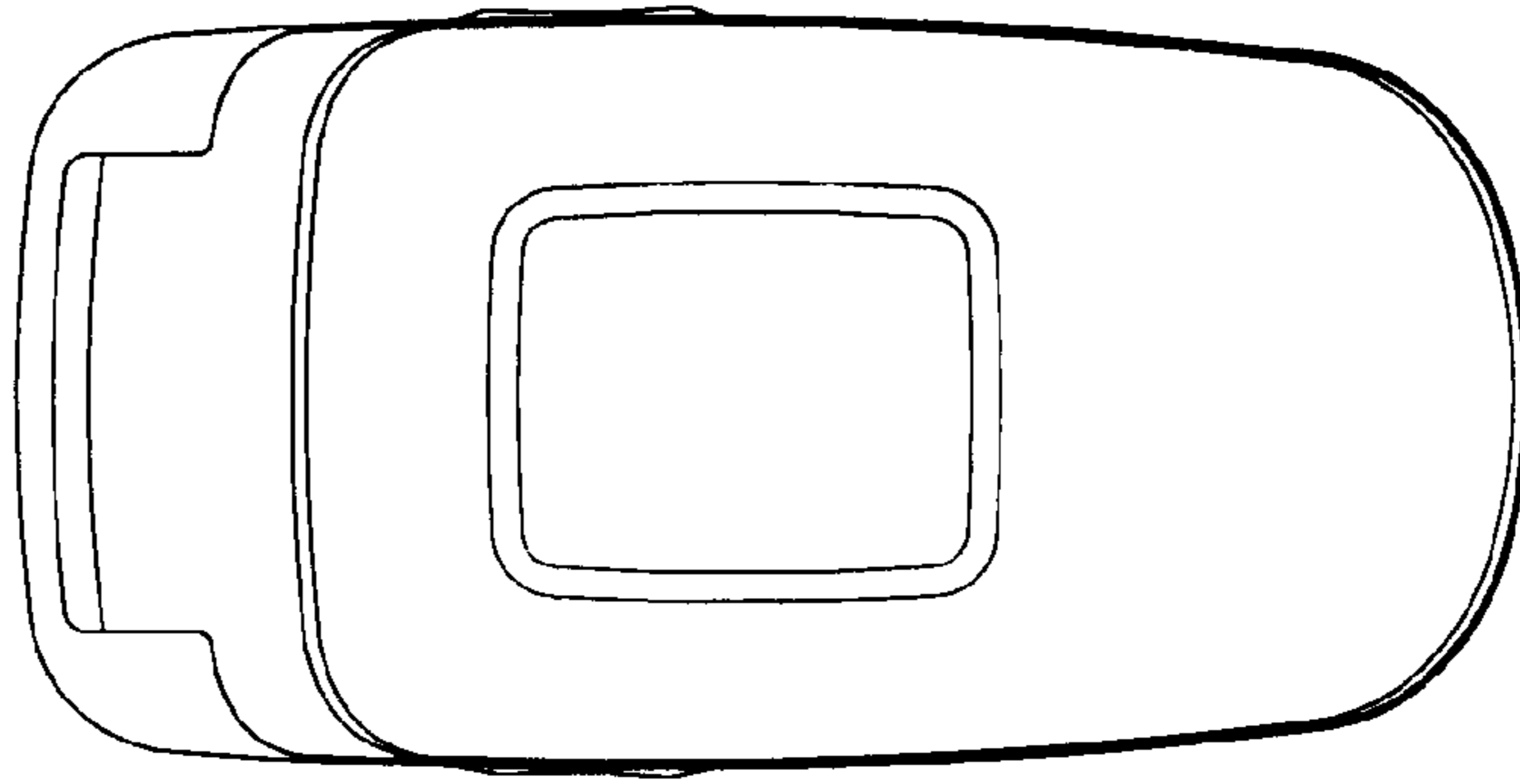

FIG. 3

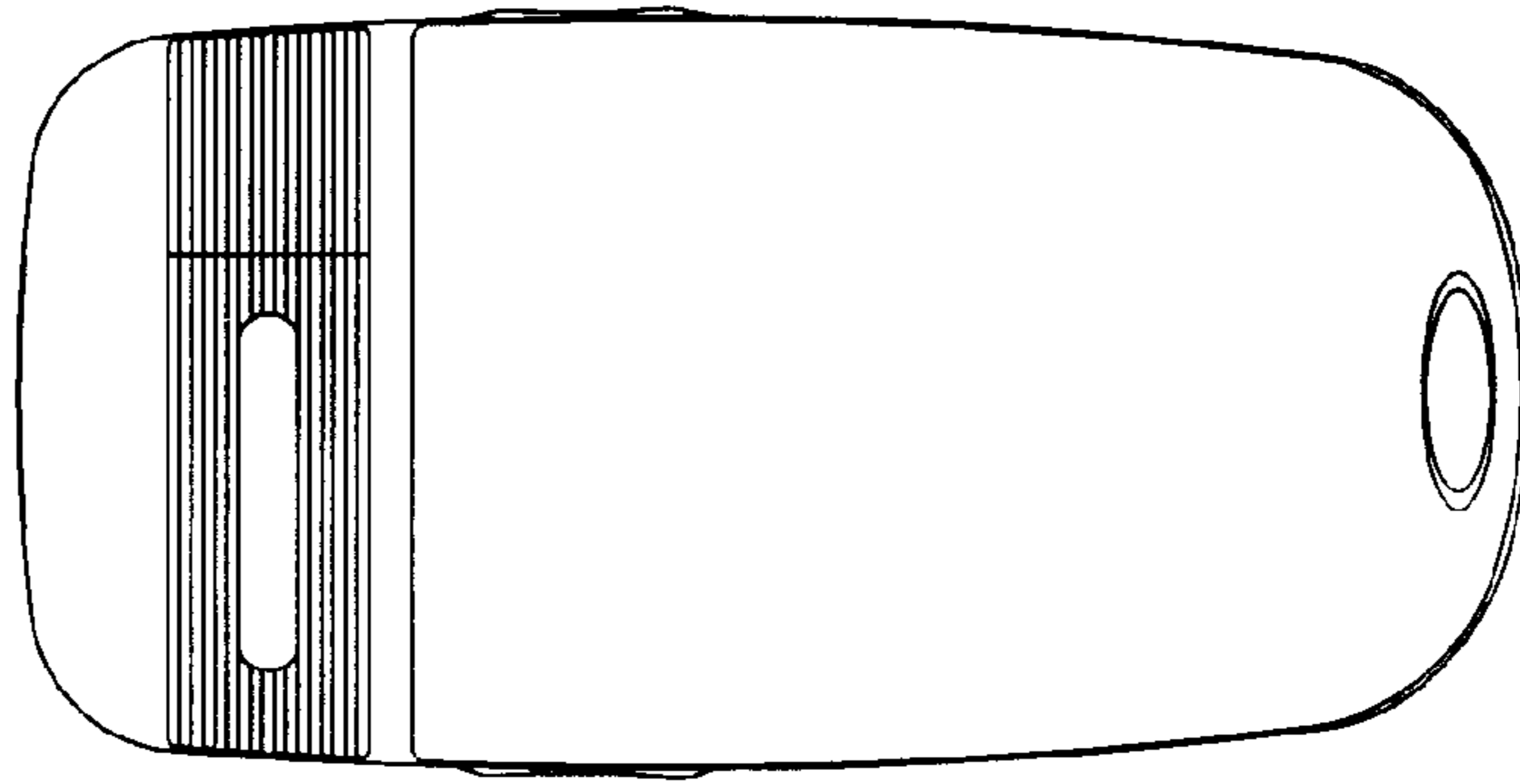

FIG. 4

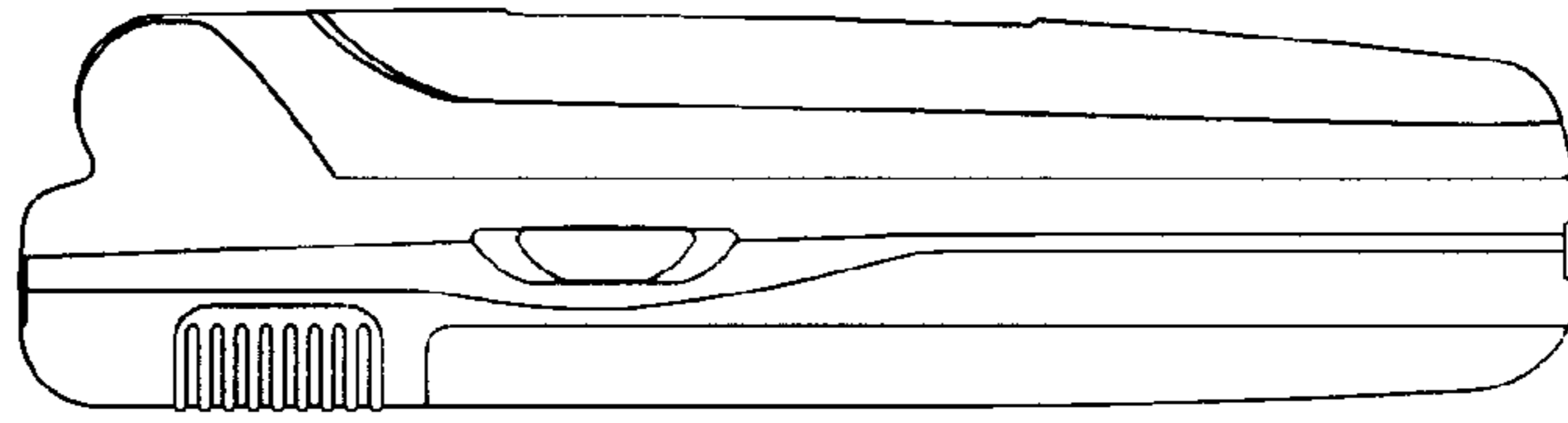

FIG. 5

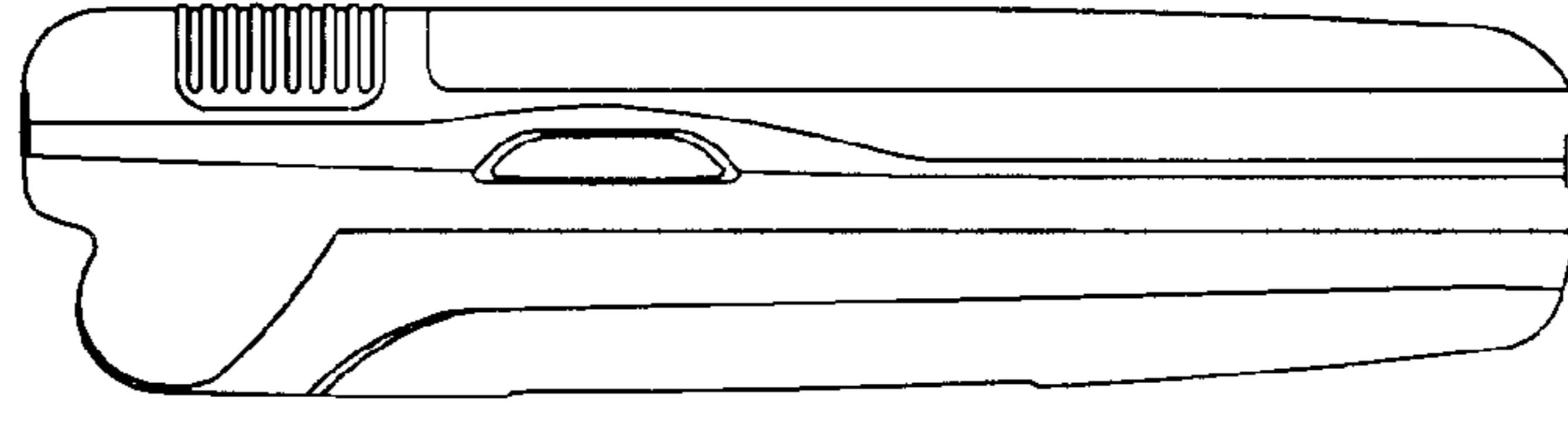

FIG. 6

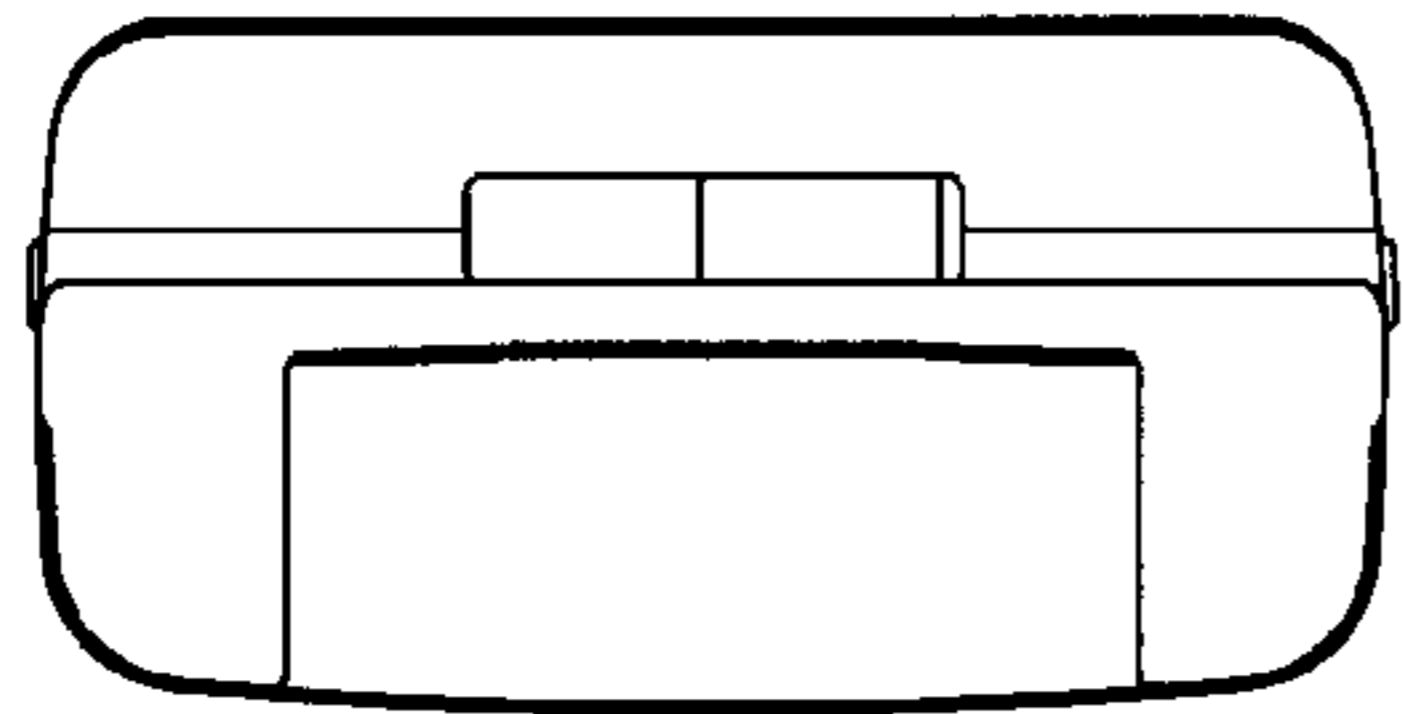

FIG. 7

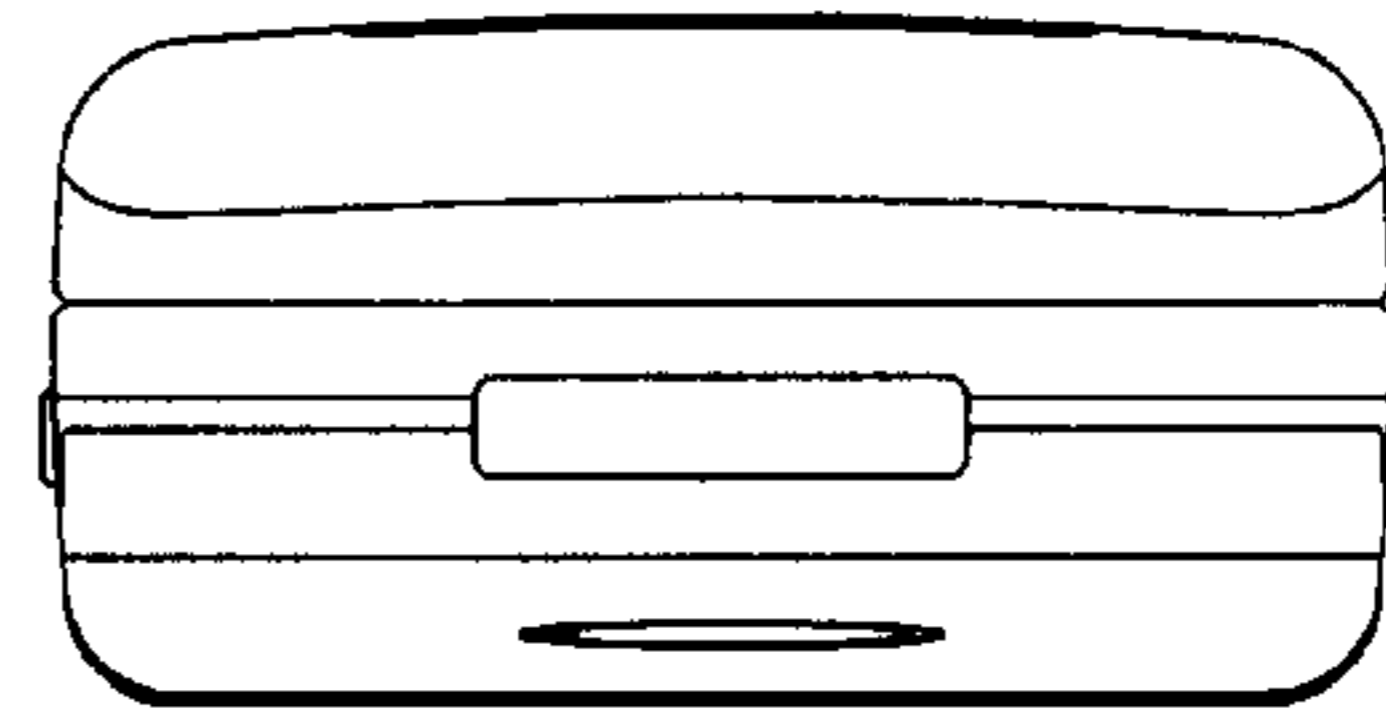

FIG. 8

