



US00D509975S

(12) **United States Design Patent**
Pan

(10) **Patent No.:** **US D509,975 S**

(45) **Date of Patent:** **** Sep. 27, 2005**

(54) **CHAIR BACK**

D491,394 S * 6/2004 Lee D6/500
D501,333 S * 2/2005 Piretti D6/366

(75) Inventor: **Toung-Chun Pan**, Tainan (TW)

* cited by examiner

(73) Assignee: **Oasyschair Co., Ltd.**, Kwan Miao Hsiang (TW)

Primary Examiner—Mimosa De

(74) *Attorney, Agent, or Firm*—Alan D. Kamrath; Nikolai & Mersereau, P.A.

(**) Term: **14 Years**

(57) **CLAIM**

(21) Appl. No.: **29/220,364**

The ornamental design for a chair back, as shown and described.

(22) Filed: **Dec. 29, 2004**

DESCRIPTION

(51) **LOC (8) Cl.** **06-06**

(52) **U.S. Cl.** **D6/502; D6/366**

(58) **Field of Search** D6/334, 335, 364,
D6/365, 366, 380, 500-502; 297/445.1,
452.29, 452.3, 452.31, 452.32

FIG. 1 is a perspective view of a chair back showing my new design;

FIG. 2 is a front side elevational view thereof;

FIG. 3 is a rear side elevational view thereof;

FIG. 4 is a left side elevational view thereof;

FIG. 5 is a right side elevational view thereof;

FIG. 6 is a top plan view thereof; and,

FIG. 7 is a bottom plan view thereof.

(56) **References Cited**

U.S. PATENT DOCUMENTS

4,864,668 A * 9/1989 Crisp 297/452.32

D456,625 S * 5/2002 Frenkler et al. D6/366

1 Claim, 5 Drawing Sheets

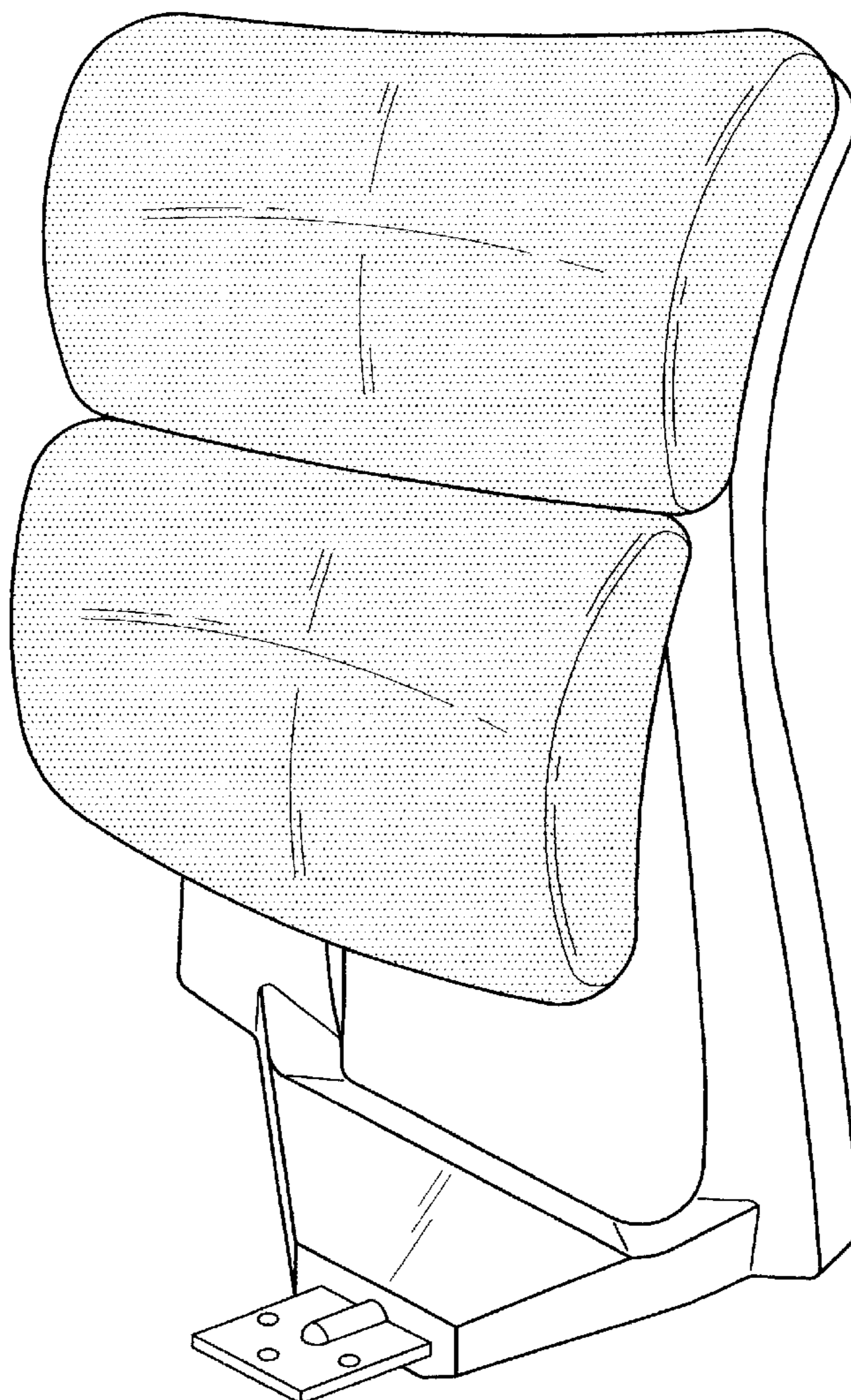

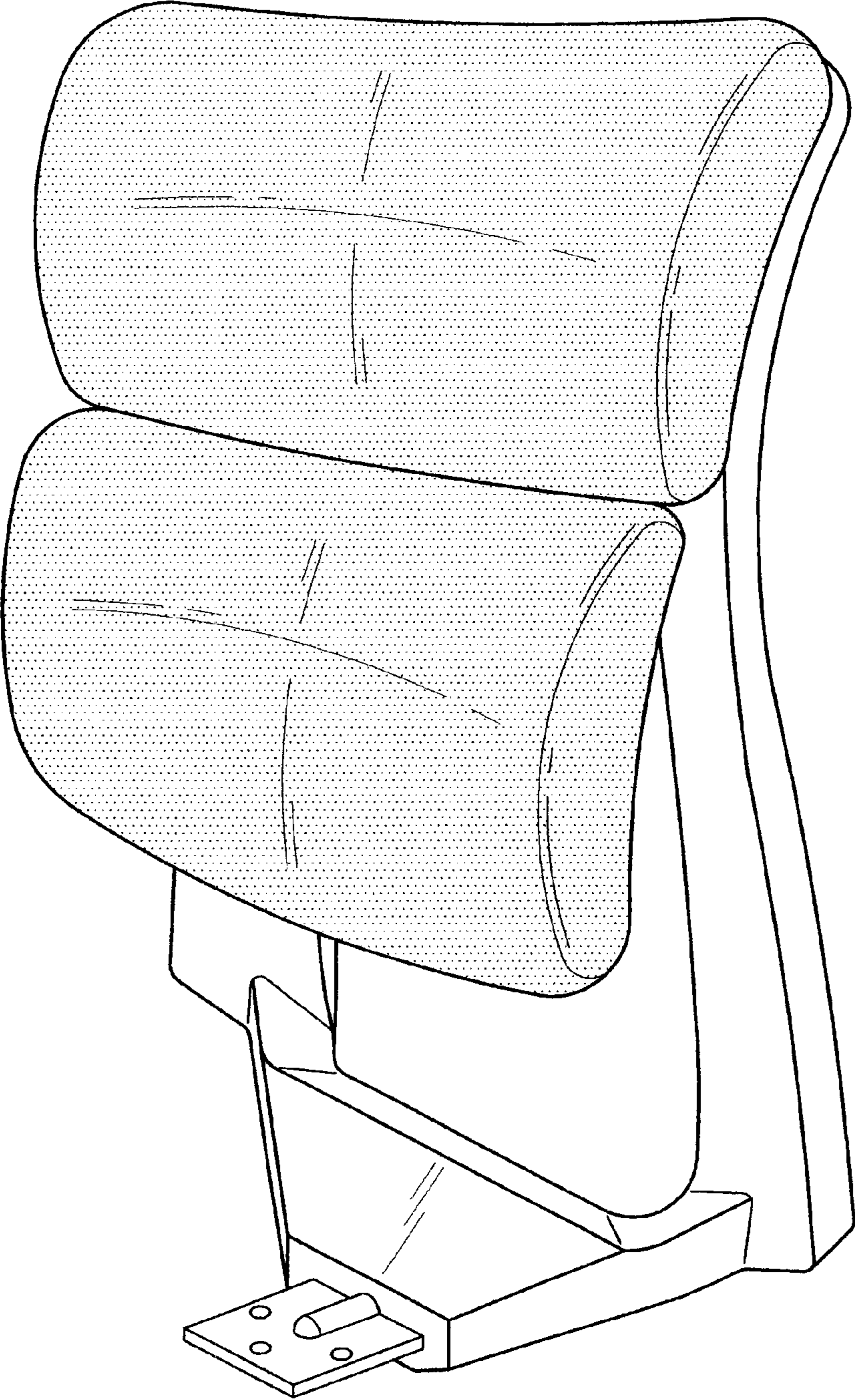

FIG. 1

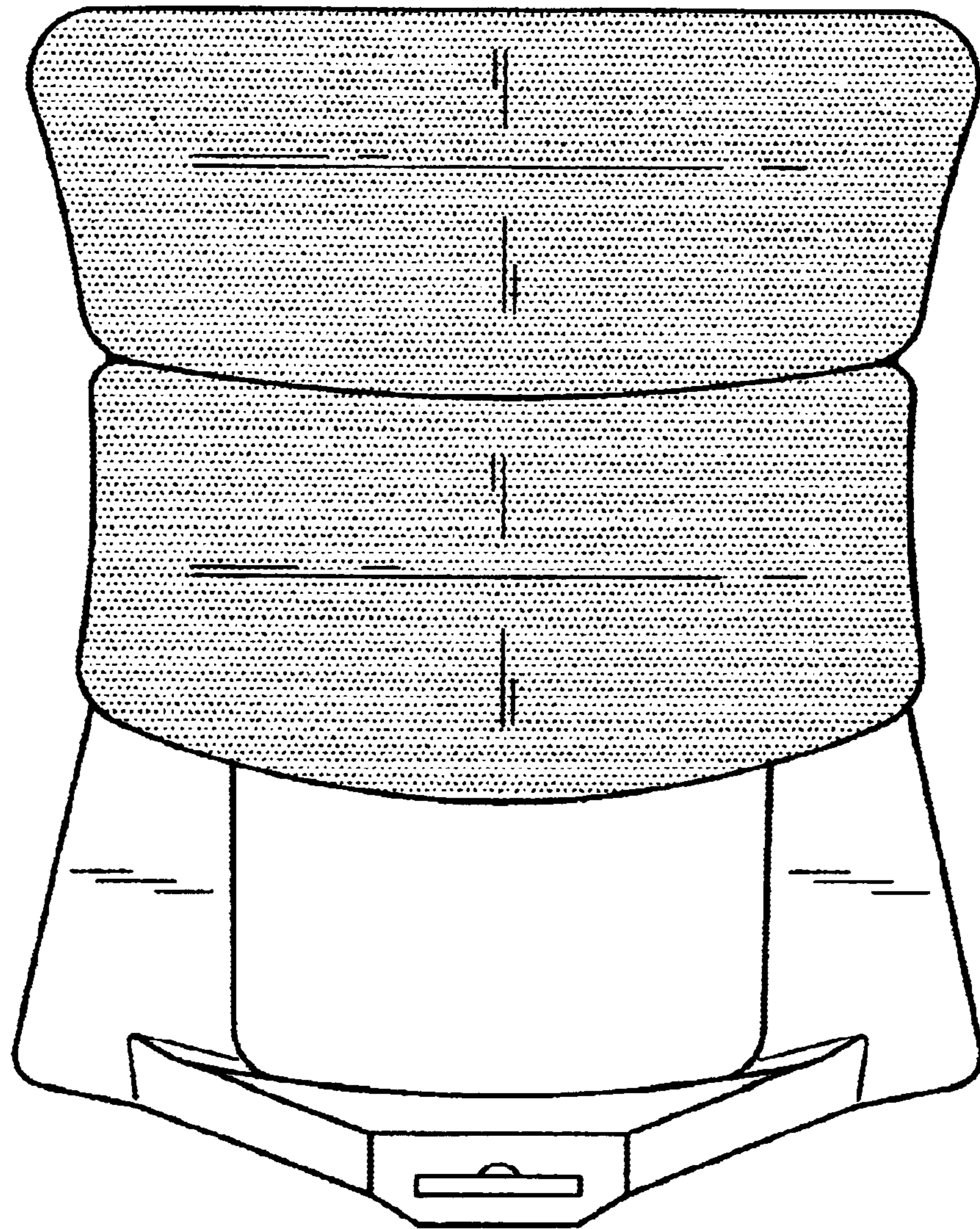

FIG. 2

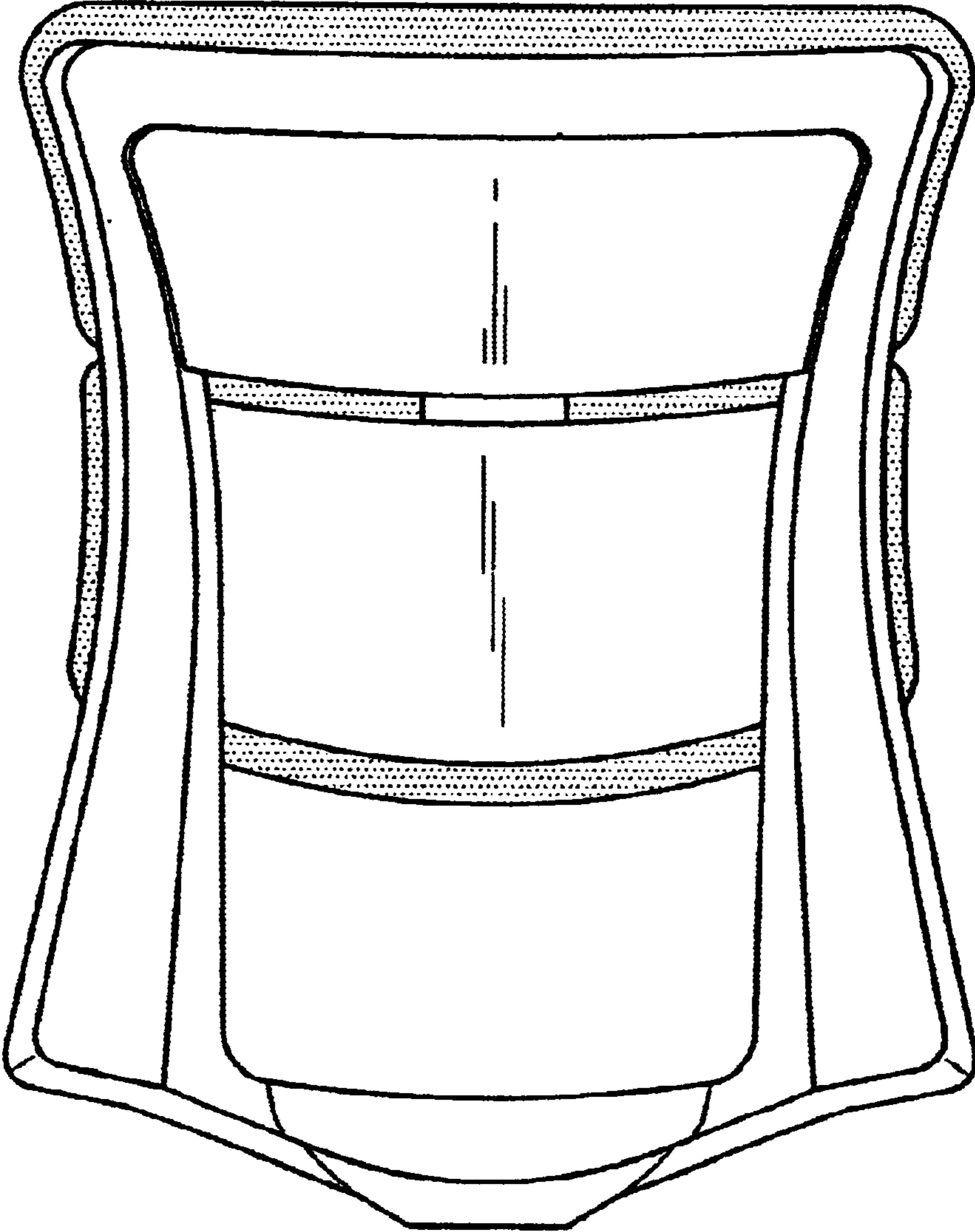

FIG. 3

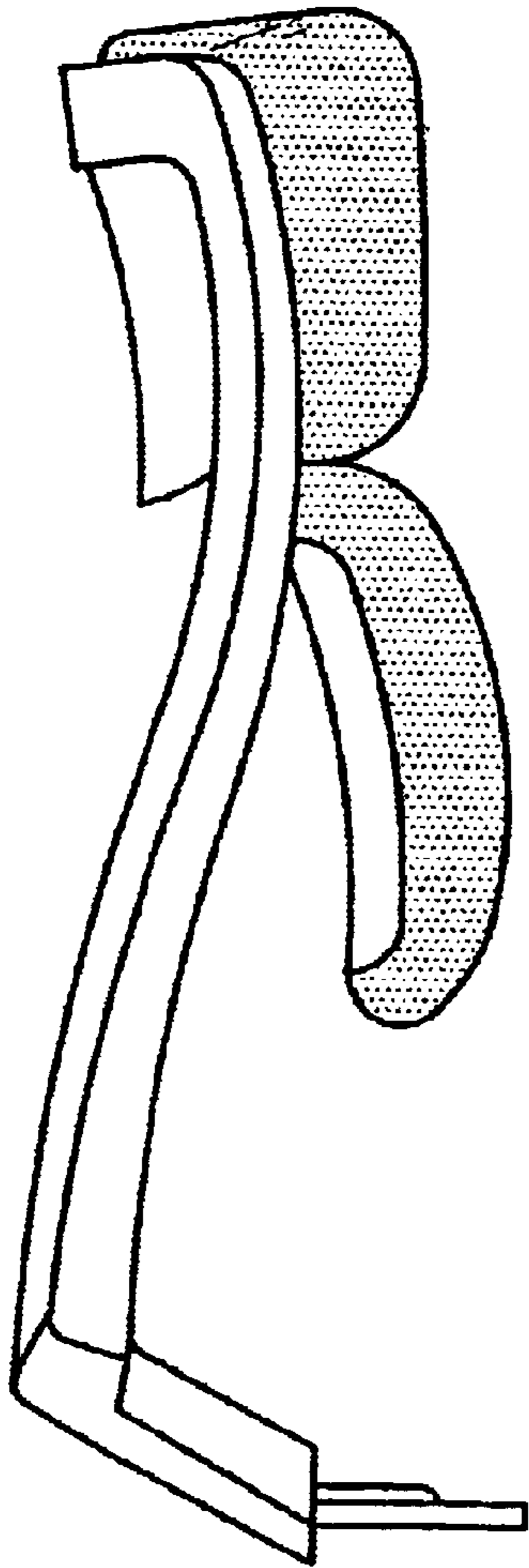

FIG. 4

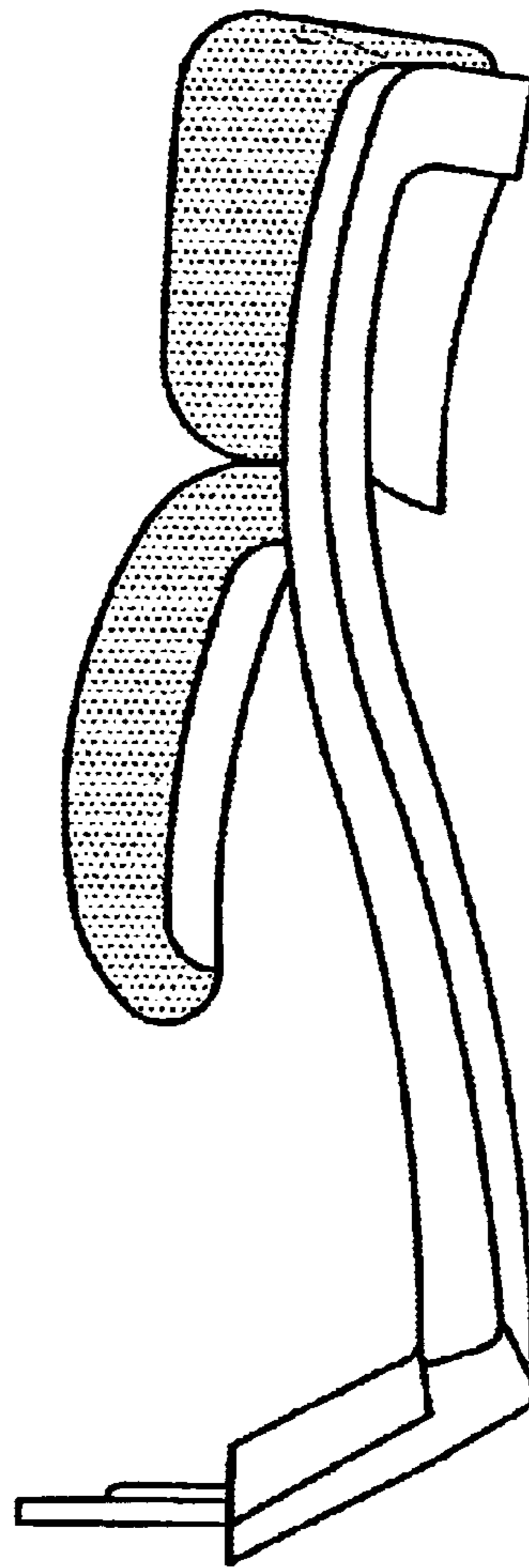

FIG. 5

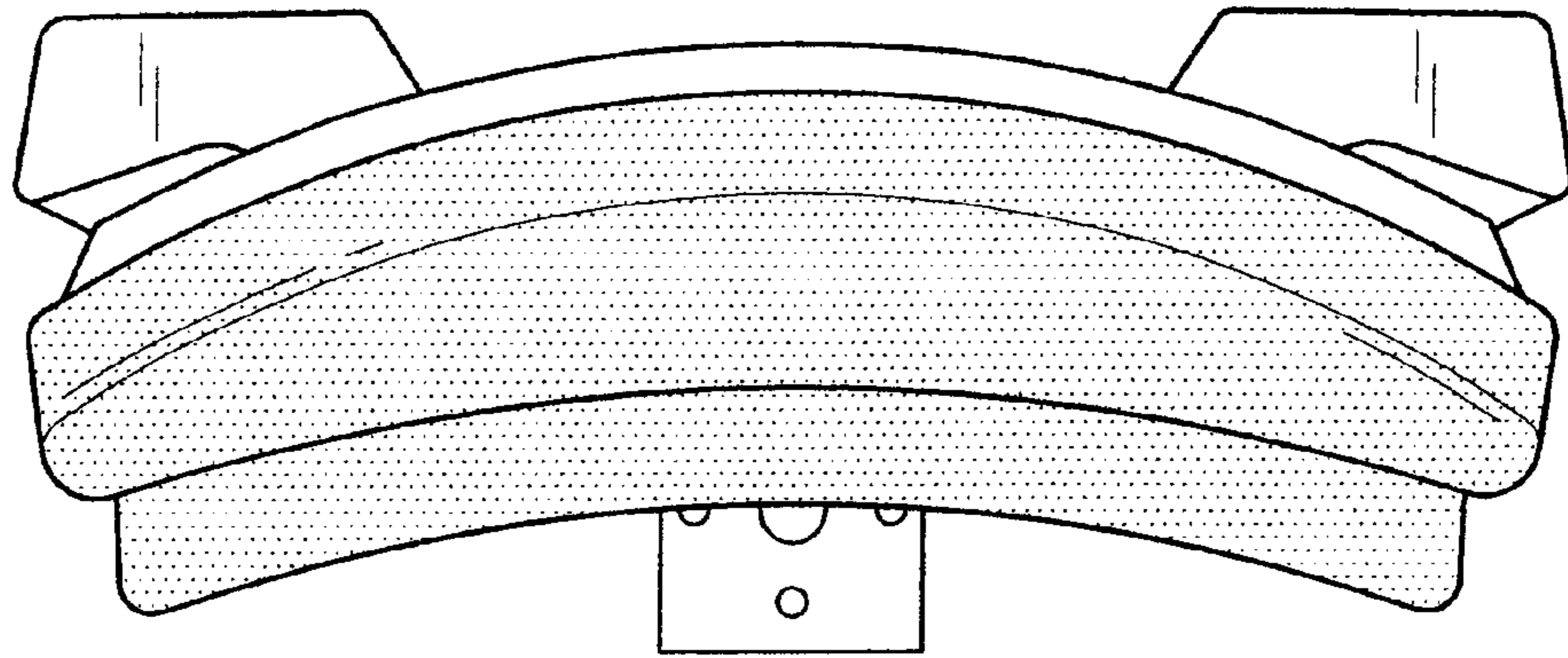

FIG. 6

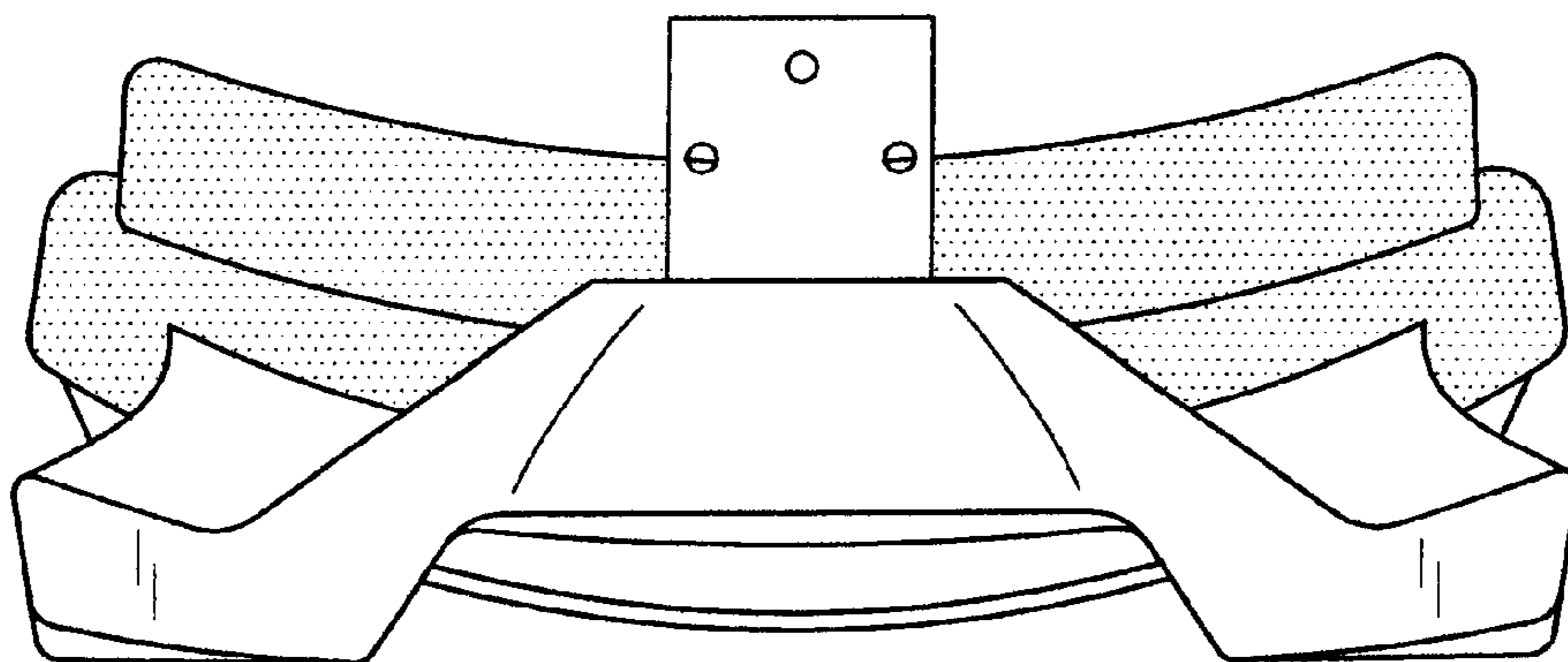

FIG. 7