



US00D509951S

(12) **United States Design Patent**
Johnson

(10) **Patent No.:** **US D509,951 S**

(45) **Date of Patent:** **** Sep. 27, 2005**

- (54) **ORTHOTIC WITH INSERT**
- (75) **Inventor:** **Robert Johnson, Fairfield, IA (US)**
- (73) **Assignee:** **Sylmark Holdings Limited (IE)**
- (**) **Term:** **14 Years**
- (21) **Appl. No.:** **29/215,051**
- (22) **Filed:** **Oct. 12, 2004**
- (51) **LOC (8) Cl. 02-99**
- (52) **U.S. Cl. D2/961**
- (58) **Field of Search D2/961; 36/44,**
36/71, 145, 154

- 6,381,875 B2 5/2002 Singer et al.
- 6,393,736 B1 5/2002 Greer, Jr. et al.
- 6,477,791 B2 11/2002 Luthi et al.
- 6,521,305 B1 2/2003 Mitchell et al.
- 6,557,273 B2 5/2003 Polifroni
- 6,560,902 B1 * 5/2003 Eschweiler 36/71
- D475,184 S 6/2003 Polifroni
- 6,594,922 B1 7/2003 Mansfield et al.
- 6,598,319 B2 7/2003 Hardt
- D485,425 S 1/2004 Polifroni
- 6,681,501 B1 1/2004 Polifroni
- D496,526 S * 9/2004 Grisoni et al. D2/961
- D496,781 S * 10/2004 Hikade et al. D2/961
- D497,474 S * 10/2004 Romero Sanchez D2/961
- 2002/0050080 A1 5/2002 Vasyli
- 2002/0083618 A1 7/2002 Erickson et al.
- 2002/0092203 A1 7/2002 Hardt
- 2003/0009915 A1 1/2003 Bacon
- 2004/0003514 A1 1/2004 Cole

(56) **References Cited**

U.S. PATENT DOCUMENTS

- 1,741,419 A * 12/1929 Jones 36/145
- 3,068,872 A * 12/1962 Brody 36/154
- 3,071,877 A * 1/1963 Stickles 36/44
- 3,543,765 A 12/1970 Alzner
- 4,739,765 A 4/1988 Sydor et al.
- 4,742,625 A 5/1988 Sydor et al.
- 4,813,157 A 3/1989 Boisvert et al.
- 4,862,604 A * 9/1989 Hauser 36/71
- 5,040,313 A 8/1991 Simjian et al.
- 5,052,130 A 10/1991 Barry et al.
- 5,191,727 A 3/1993 Barry et al.
- 5,203,793 A 4/1993 Lyden
- 5,315,769 A 5/1994 Barry et al.
- D357,349 S * 4/1995 Vasyli D2/961
- D367,164 S * 2/1996 Fisher et al. D2/961
- 5,772,945 A 6/1998 Brown
- 5,952,065 A 9/1999 Mitchell et al.
- 5,960,566 A 10/1999 Brown
- 5,996,254 A 12/1999 Goven
- D422,782 S * 4/2000 Kress et al. D2/961
- 6,269,555 B1 8/2001 Brown
- D456,126 S * 4/2002 Grisoni et al. D2/961

* cited by examiner

Primary Examiner—Dominic Simone
(74) *Attorney, Agent, or Firm*—Kathy Mojibi Kavcioglu

(57) **CLAIM**

I claim the ornamental design for the orthotic with insert, as shown and described.

DESCRIPTION

FIG. 1 is an exploded perspective view of an orthotic with insert showing my new design in accordance with a preferred embodiment;
FIG. 2 is a left side elevational view thereof;
FIG. 3 is a right side elevational view thereof;
FIG. 4 is a top plan view thereof;
FIG. 5 is a bottom plan view thereof;
FIG. 6 is a front view thereof; and,
FIG. 7 is a rear view thereof.

1 Claim, 5 Drawing Sheets

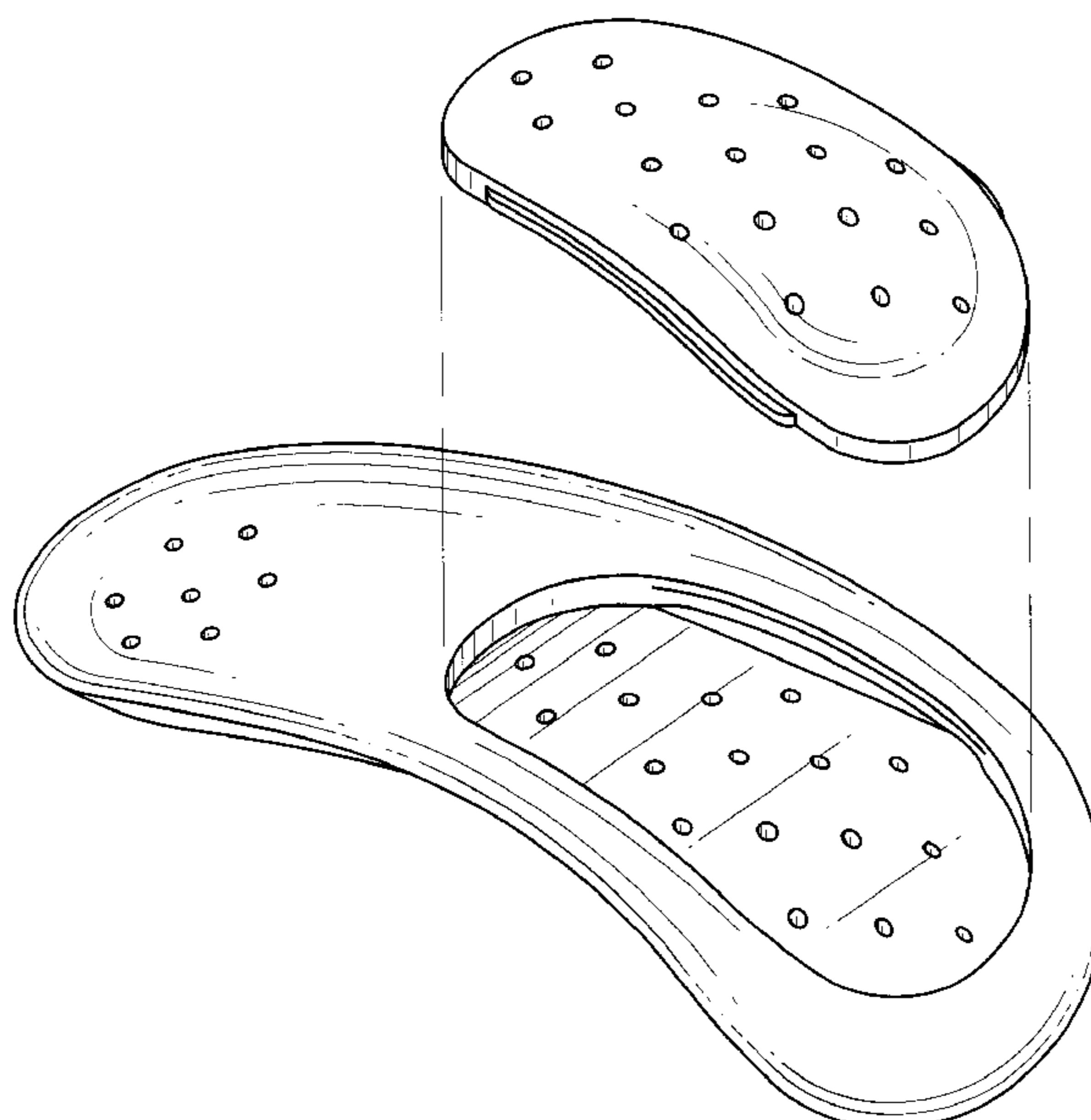

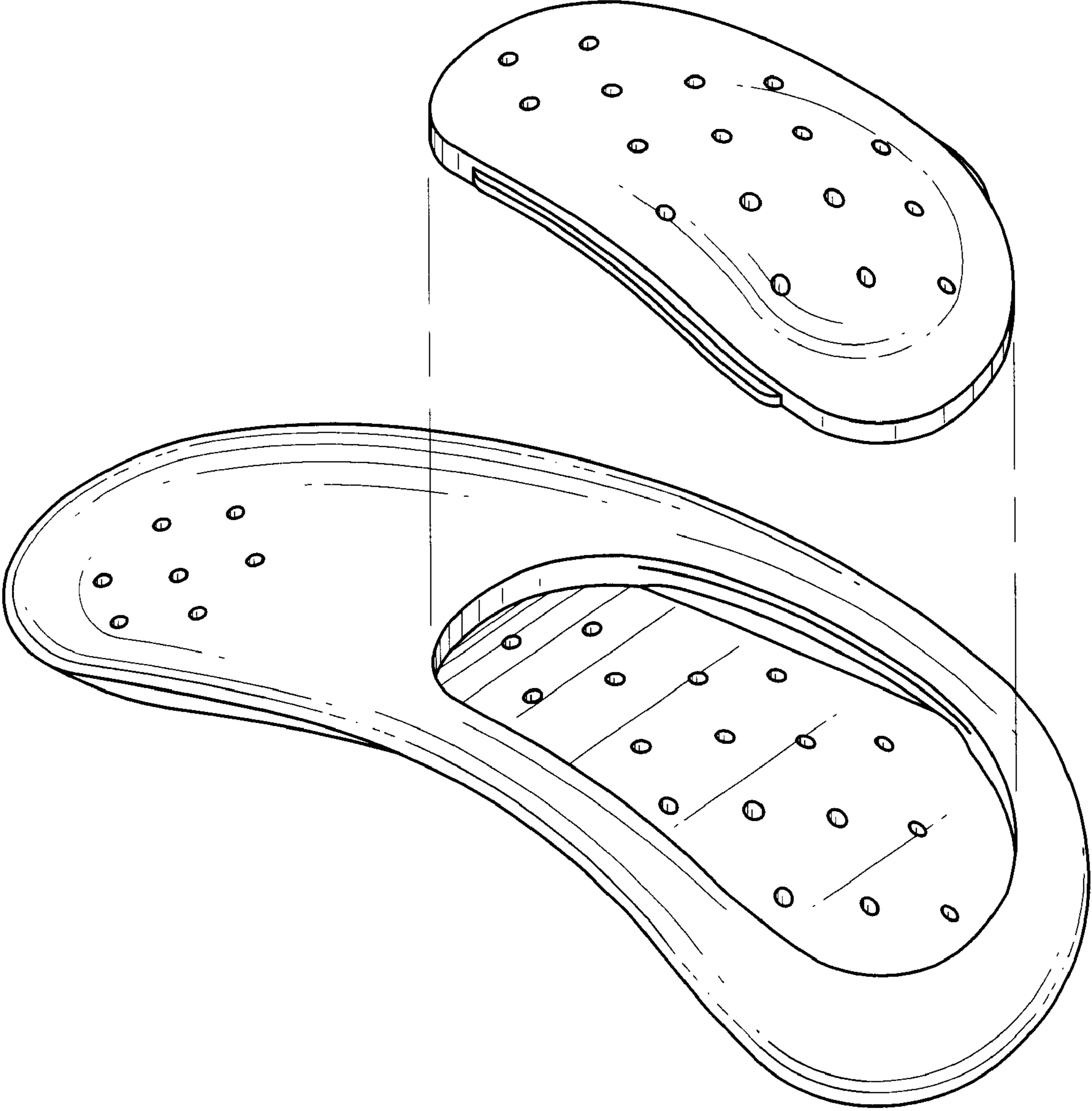

FIG. 1

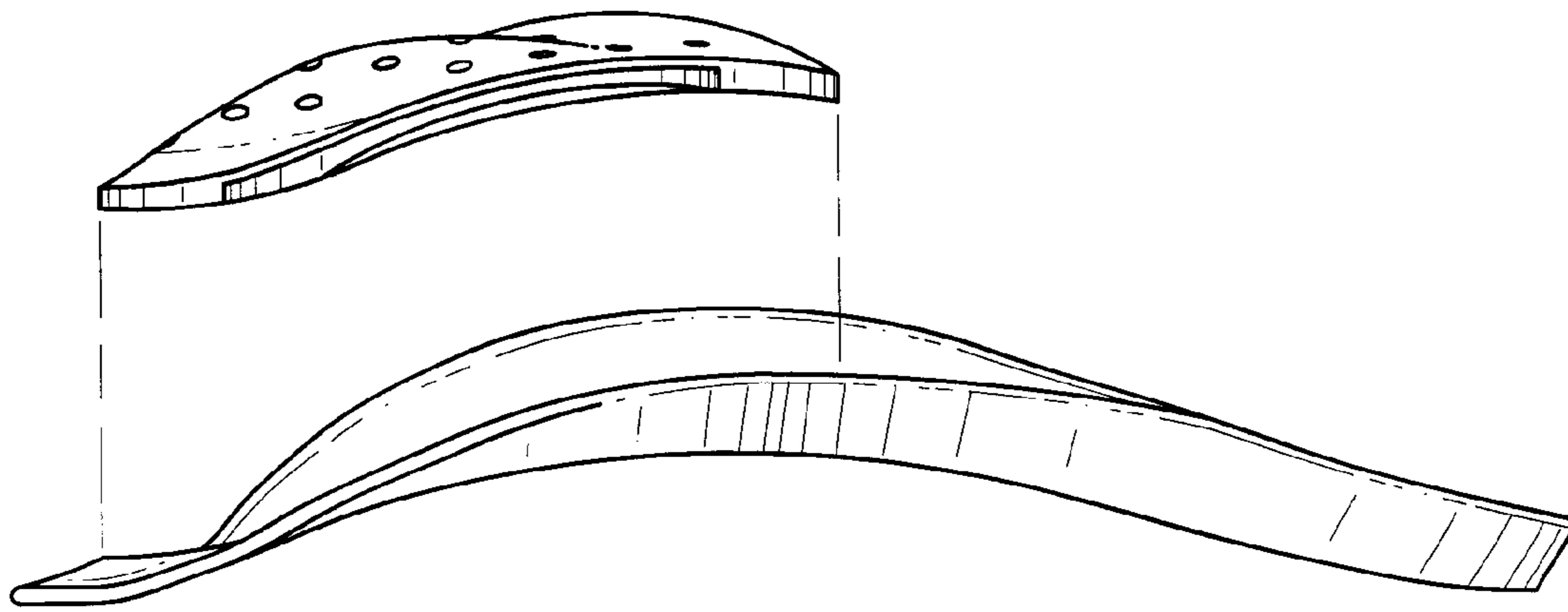

FIG. 2

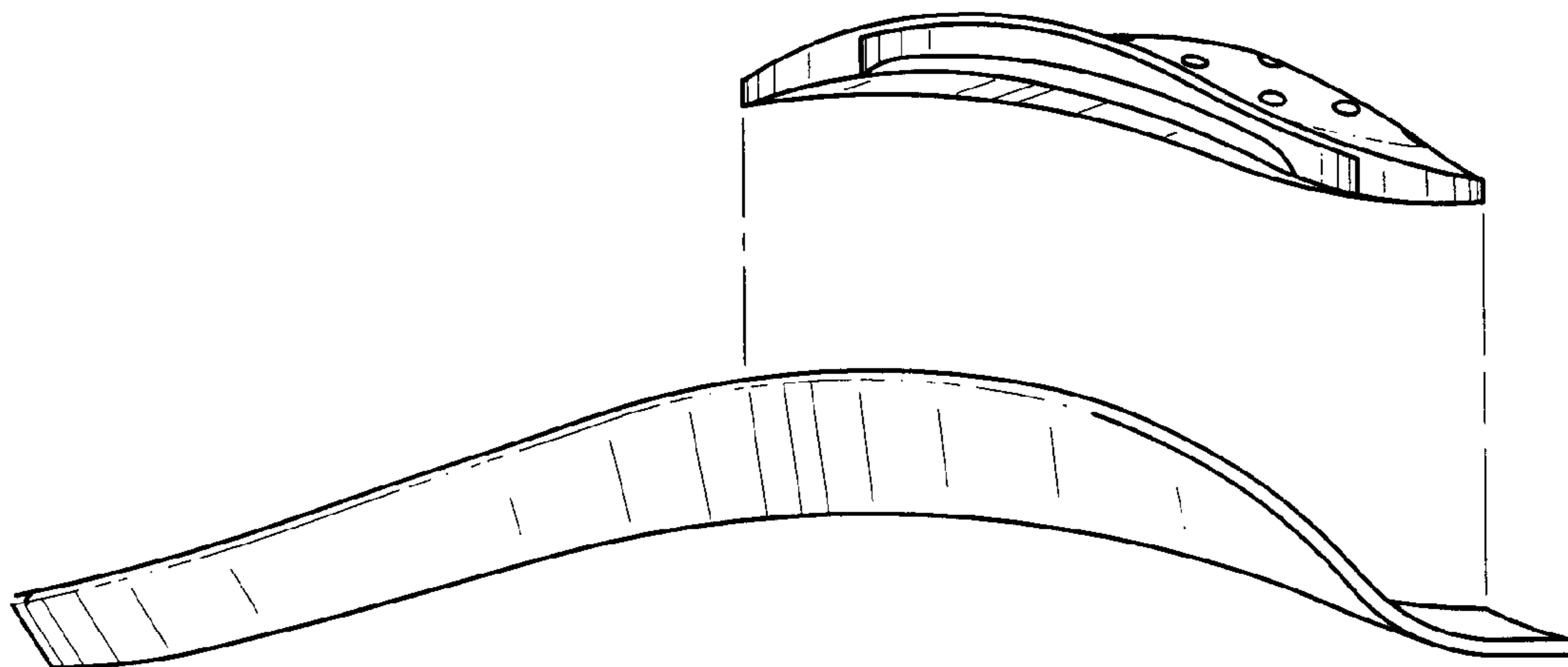

FIG. 3

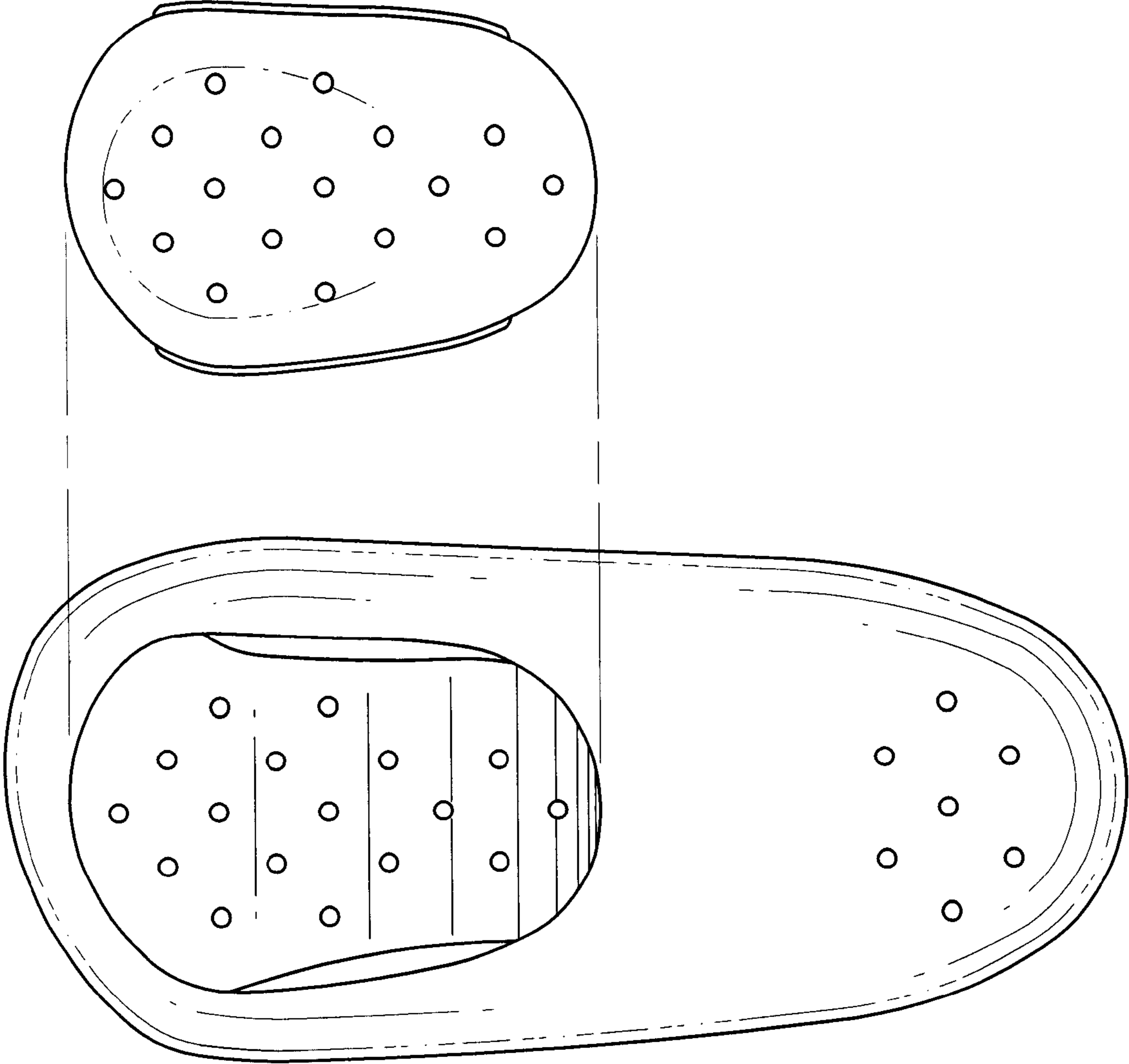

FIG. 4

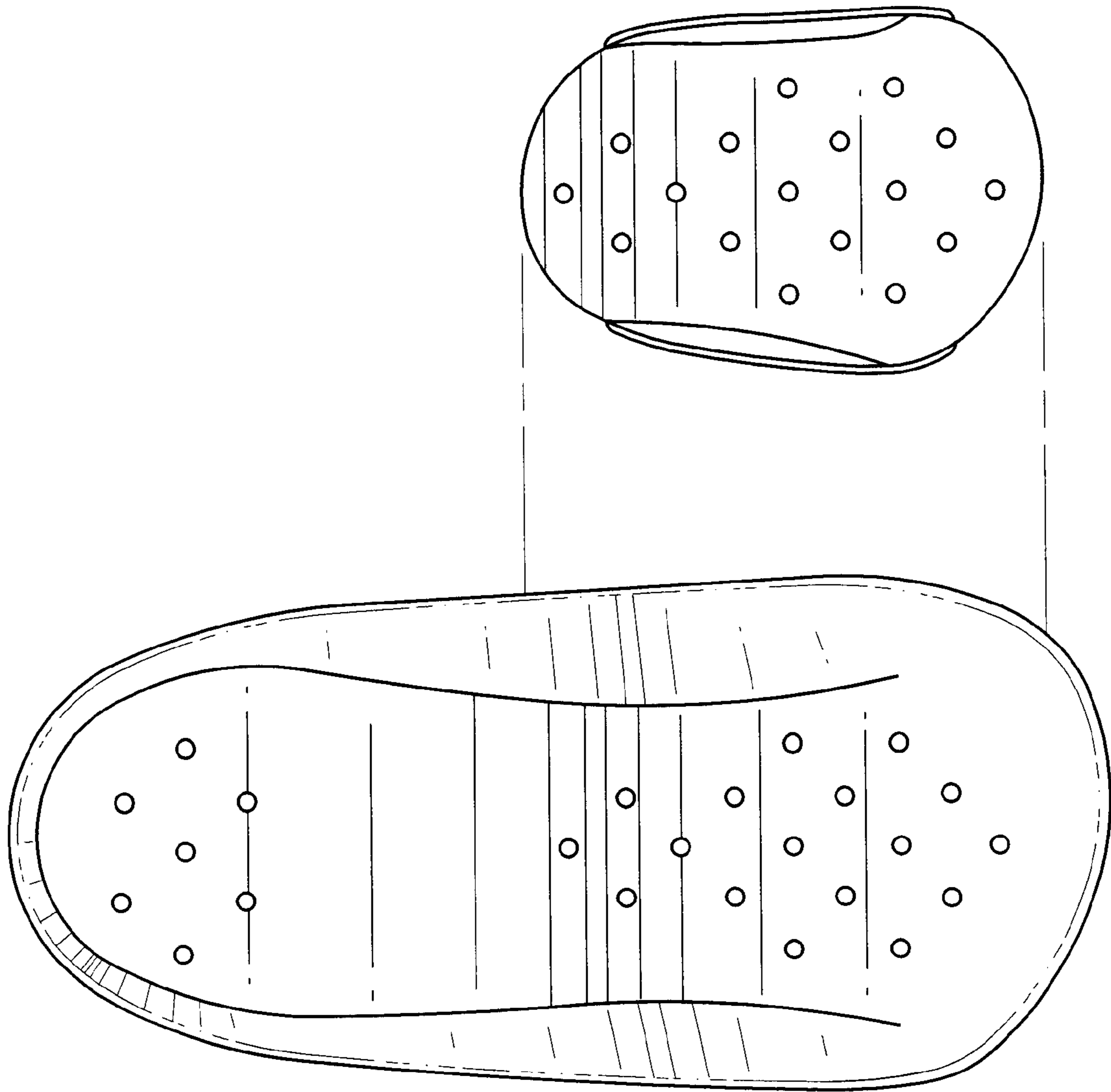

FIG. 5

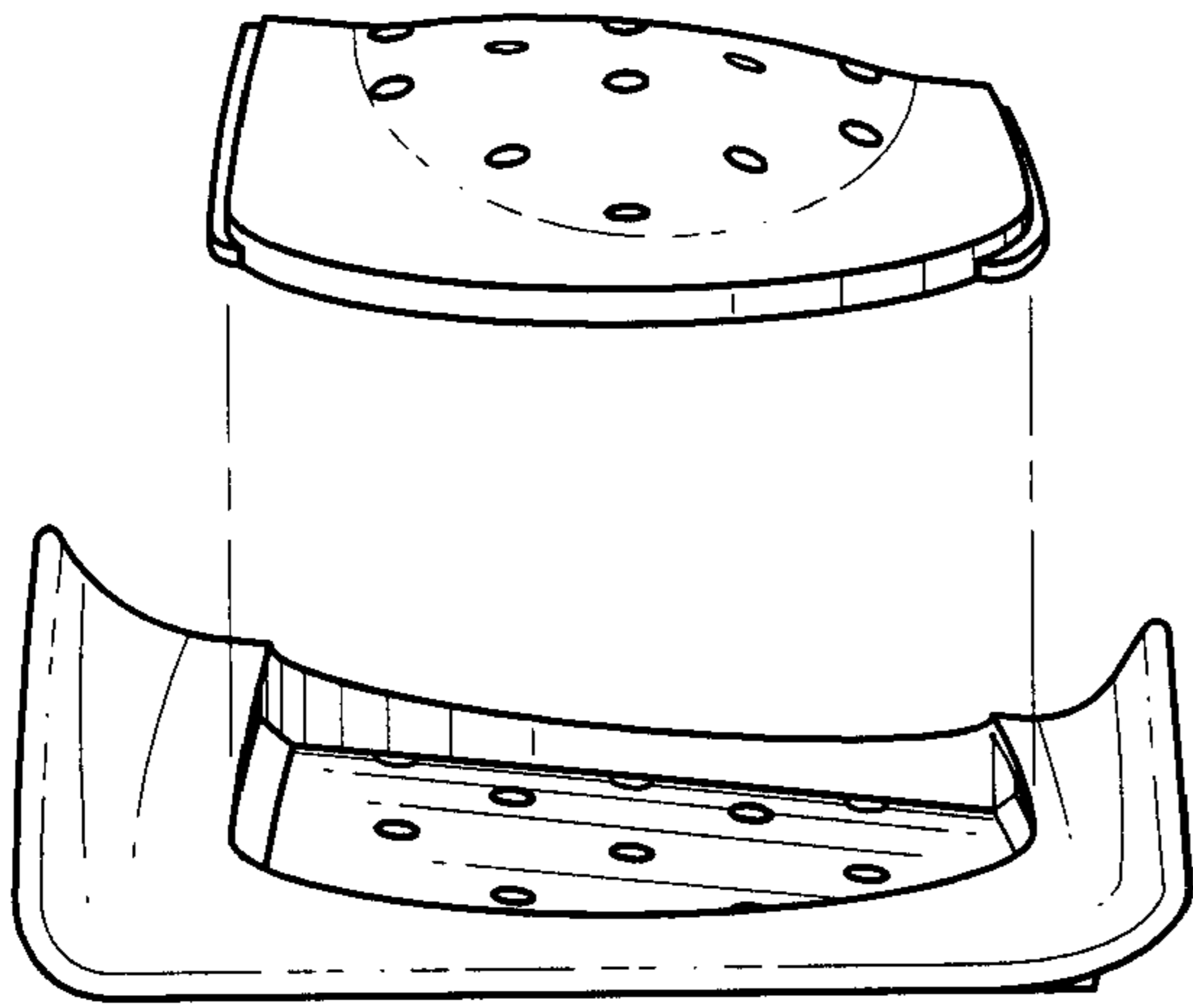

FIG. 6

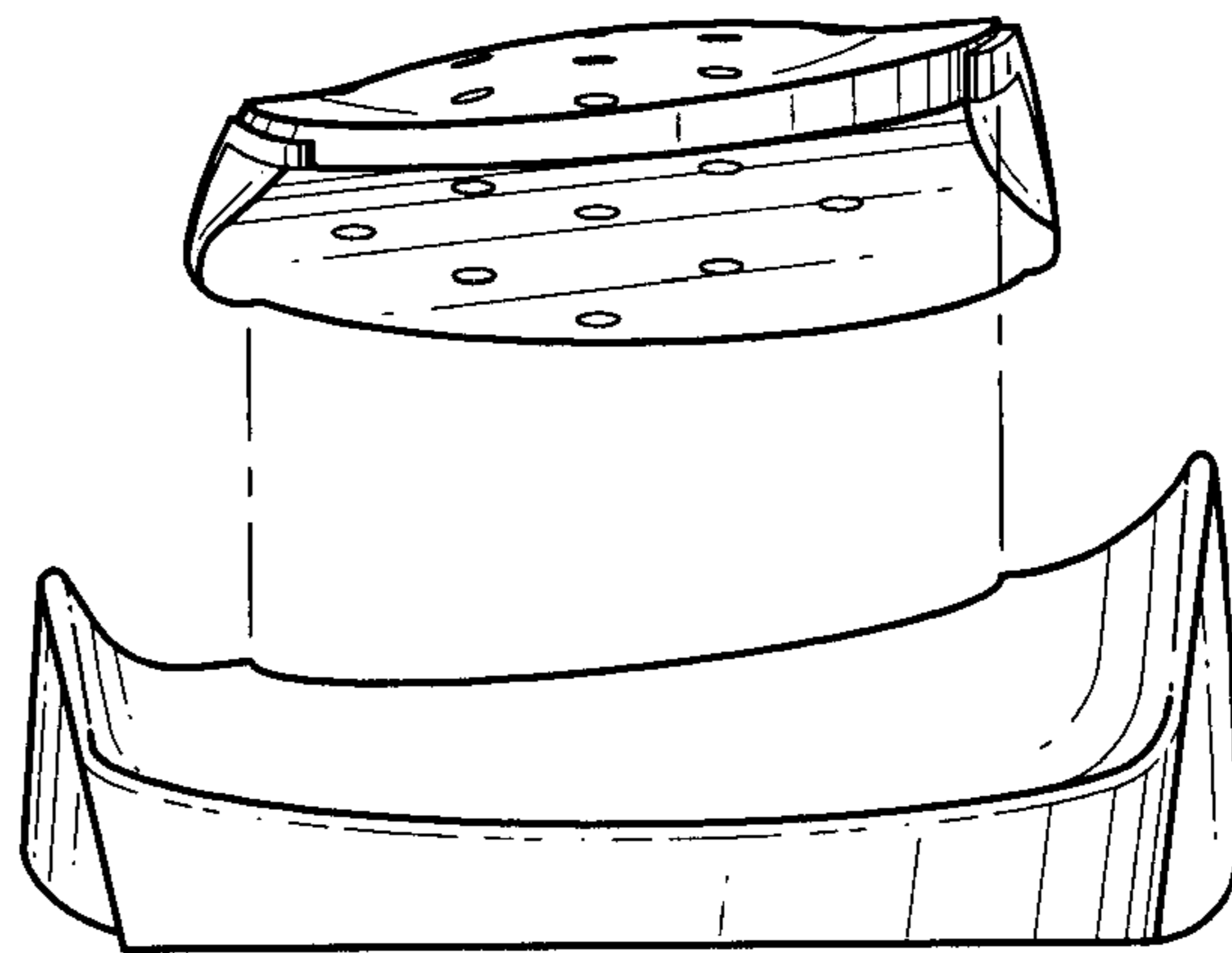

FIG. 7