

US00D509932S

(12) **United States Design Patent**
Shin

(10) **Patent No.: US D509,932 S**

(45) **Date of Patent: ** Sep. 20, 2005**

(54) **VACUUM CLEANER**

(75) **Inventor: Hyon Seon Shin, Gyeonggi-do (KR)**

(73) **Assignee: LG Electronics Inc., Seoul (KR)**

(**) **Term: 14 Years**

(21) **Appl. No.: 29/203,459**

(22) **Filed: Apr. 15, 2004**

(30) **Foreign Application Priority Data**

Oct. 17, 2003 (KR) 30-2003-0029107

(51) **LOC (8) Cl. 15-05**

(52) **U.S. Cl. D32/22**

(58) **Field of Search** D32/22, 30-34;
15/320-321, 347, 350-351, 353, 361, 410,
412, 414, 246.2, DIG. 8; 55/318, 337, 400,
DIG. 3, 429, 459.1, 345, 447; 95/271, 268;
210/512.1, 512.2

(56) **References Cited**

U.S. PATENT DOCUMENTS

D316,167 S * 4/1991 Petralia et al. D32/22

D398,098 S * 9/1998 Mehaffey et al. D32/22
D413,187 S * 8/1999 Wang et al. D32/22
5,961,676 A * 10/1999 King et al. 55/334
D429,854 S * 8/2000 Hohulin et al. D32/22
D434,884 S * 12/2000 Hohulin et al. D32/22
D499,220 S * 11/2004 Kim D32/22

* cited by examiner

Primary Examiner—Ruth McInroy

(74) *Attorney, Agent, or Firm*—Birch, Stewart, Kolasch & Birch, LLP

(57) **CLAIM**

The ornamental design for vacuum cleaner, as shown and described.

DESCRIPTION

FIG. 1 is a perspective view of the vacuum cleaner;
FIG. 2 is a front view thereof;
FIG. 3 is a rear view thereof;
FIG. 4 is a left side view thereof;
FIG. 5 is a right side view thereof;
FIG. 6 is a top plan view thereof; and,
FIG. 7 is a bottom plan view thereof.

1 Claim, 6 Drawing Sheets

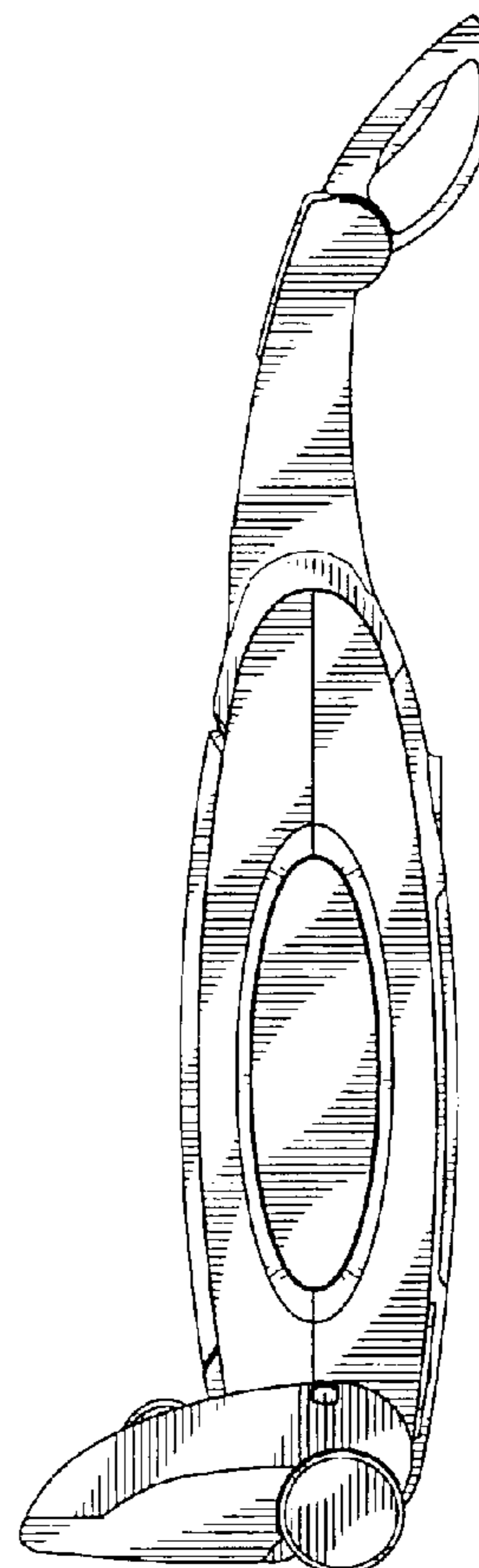
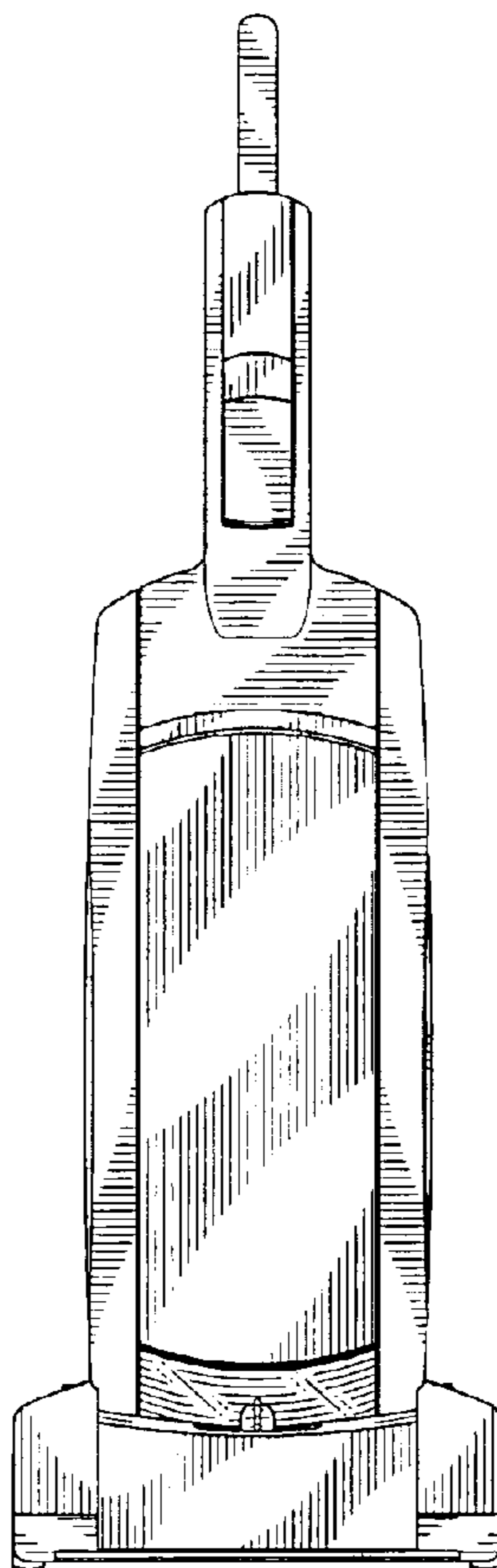
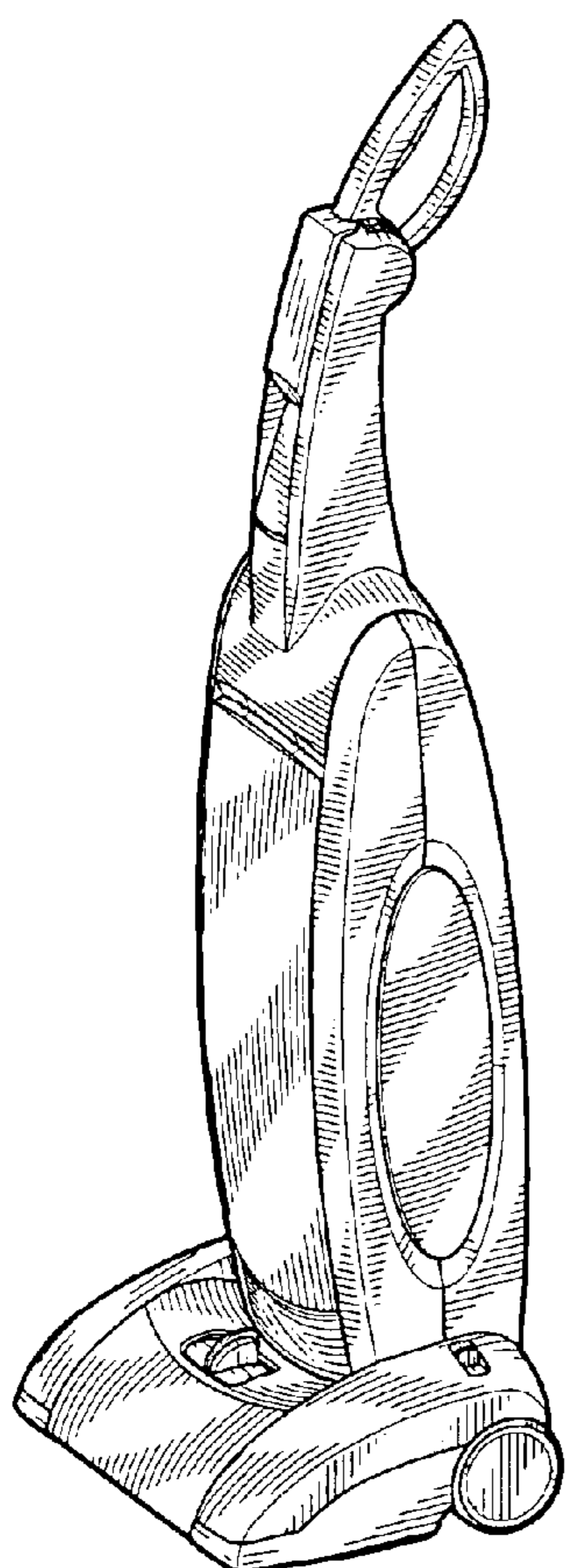

FIG. 1

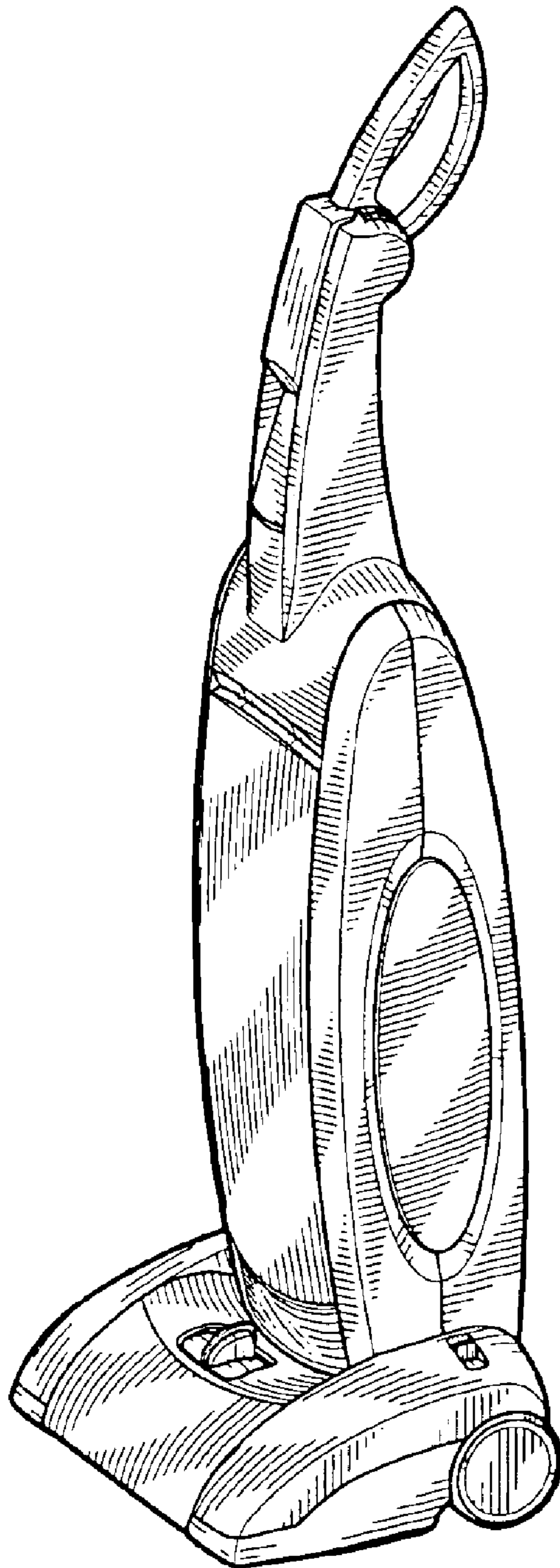

FIG. 2

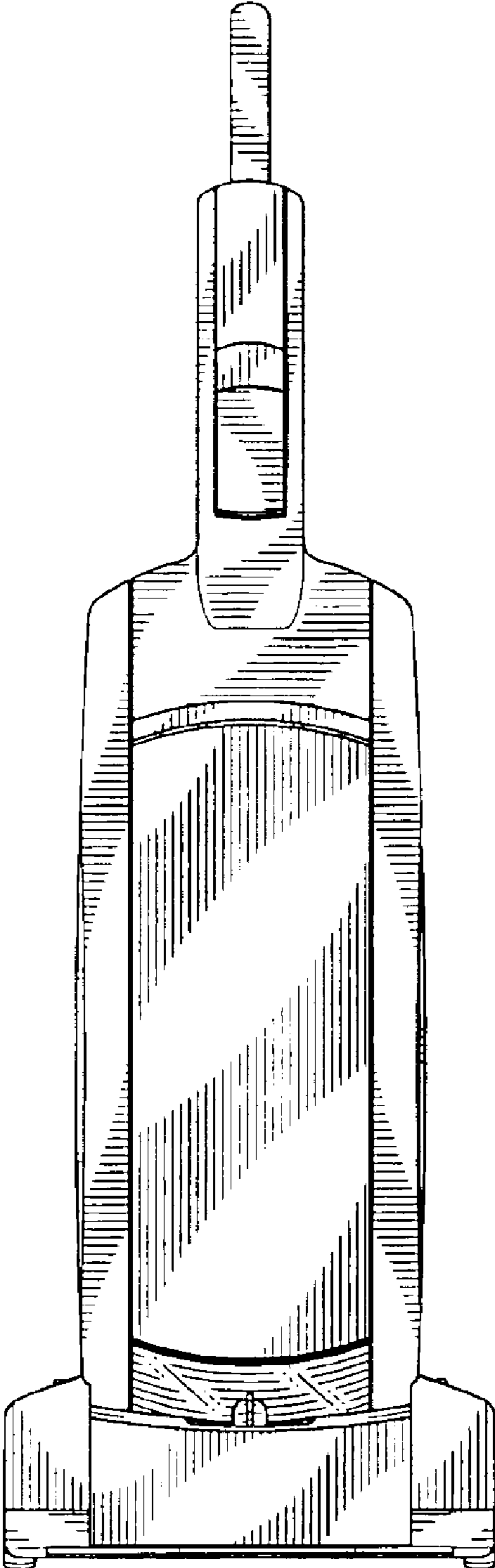

FIG. 3

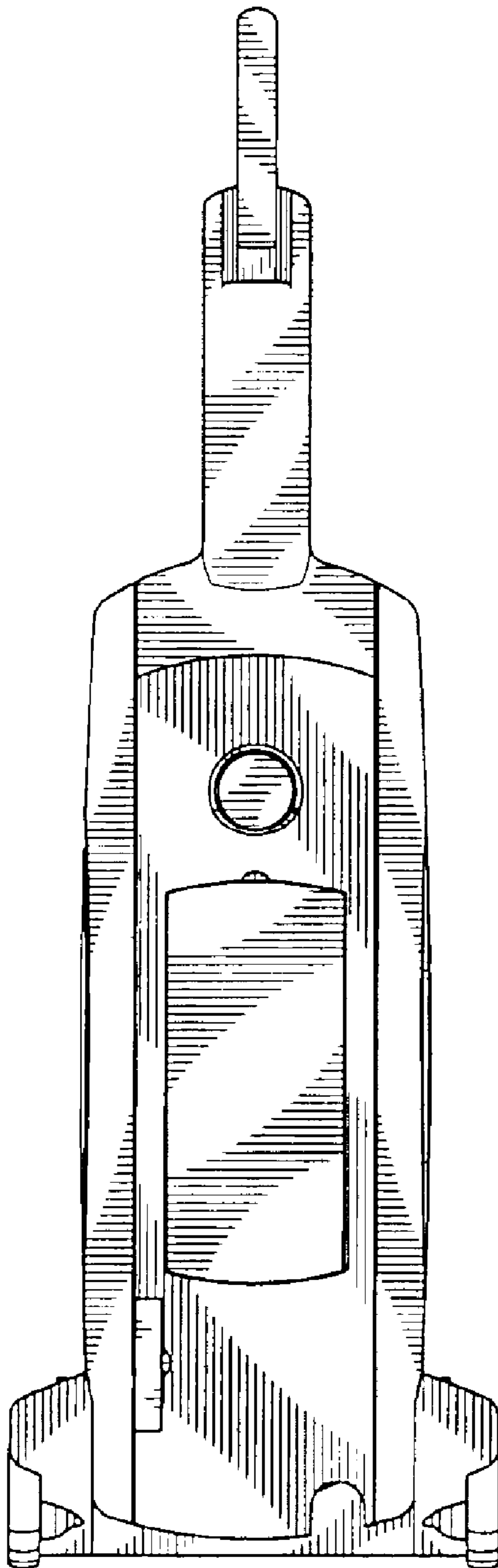

FIG. 4

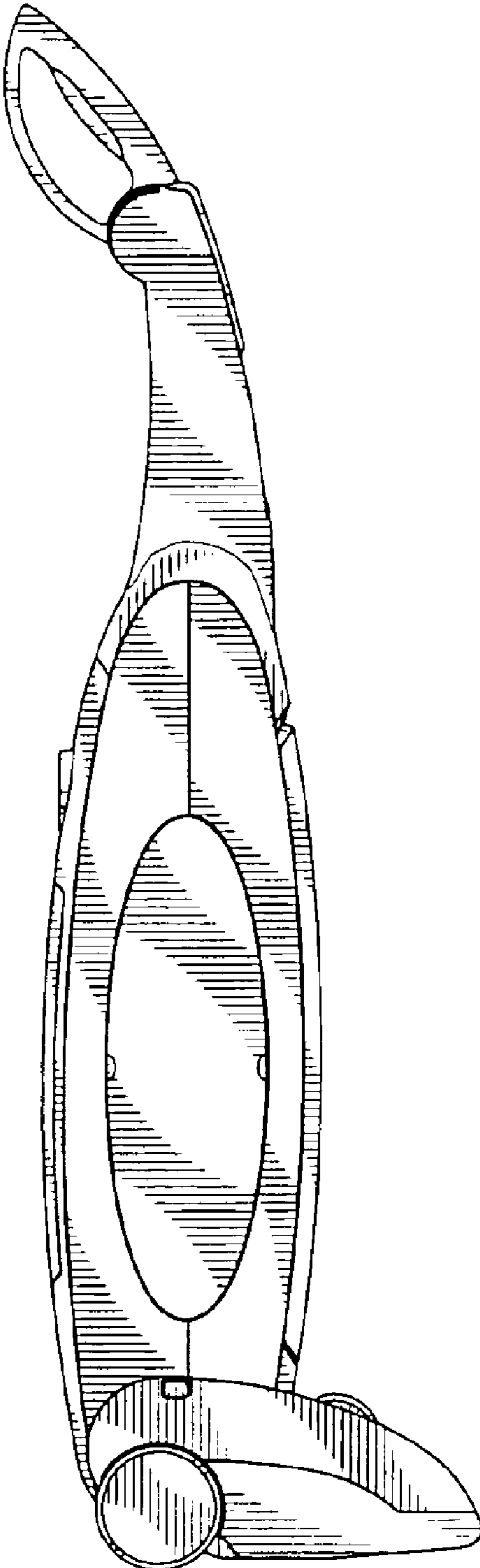

FIG. 5

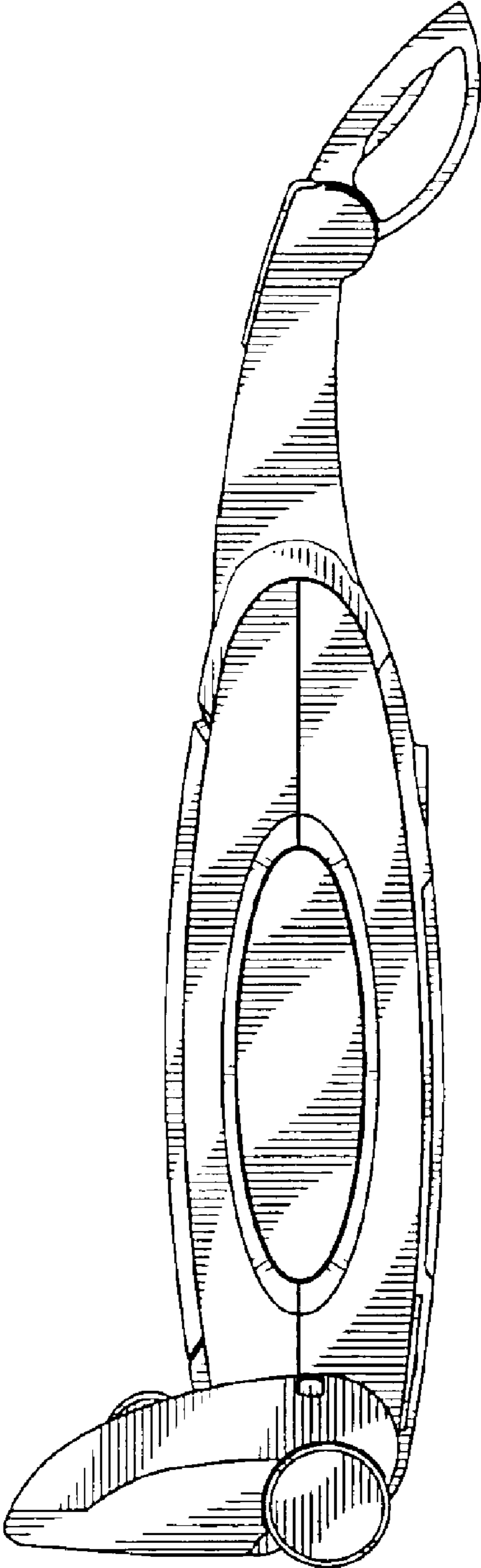

FIG. 6

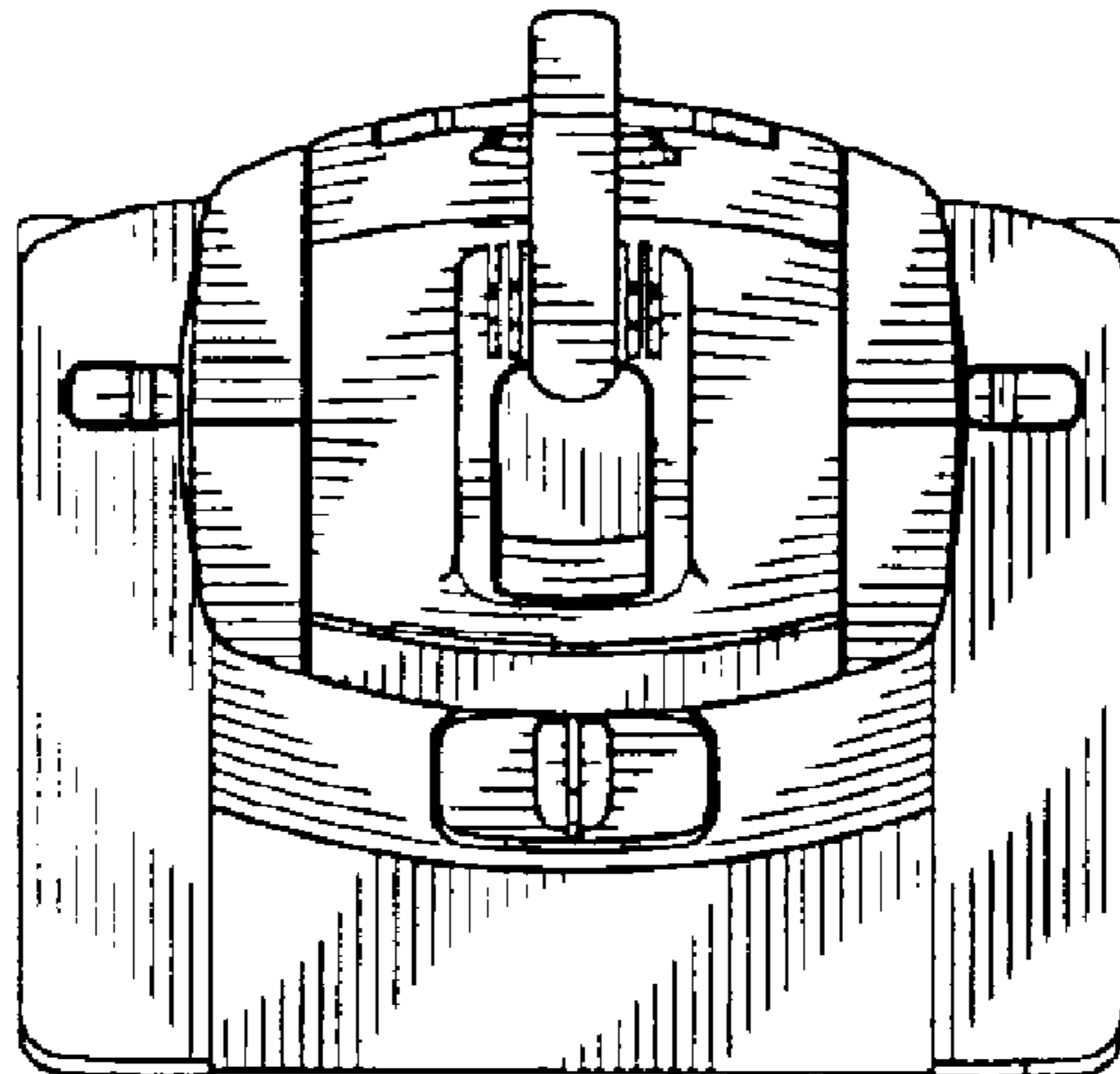

FIG. 7

