

US00D509822S

(12) **United States Design Patent**
Schwimmer et al.

(10) **Patent No.: US D509,822 S**
(45) **Date of Patent: ** Sep. 20, 2005**

(54) **HANDSFREE ACCESSORY FOR PHONES**

(75) Inventors: **Alan Schwimmer**, Northbrook, IL
(US); **Voyteck Skuza**, Park Ridge, IL
(US); **Michael B. Grimm**, Evanston, IL
(US); **Michael E. Beatty**, Naperville, IL
(US)

(73) Assignee: **SAFCO Corporation**, Skokie, IL (US)

(**) Term: **14 Years**

(21) Appl. No.: **29/185,449**

(22) Filed: **Jun. 26, 2003**

(51) **LOC (8) Cl.** **14-03**

(52) **U.S. Cl.** **D14/204**; 13/144

(58) **Field of Search** D14/240, 243.1,
D14/140, 142; D13/144; 455/569, 570;
379/422, 424, 426, 427

(56) **References Cited**

U.S. PATENT DOCUMENTS

D359,269 S * 6/1995 Wharton D13/144
D384,036 S * 9/1997 Janci D13/144

D403,663 S * 1/1999 Jones et al. D13/144
D404,037 S * 1/1999 Gomez et al. D14/240
D463,369 S * 9/2002 Eisenbraun D13/144
D468,265 S * 1/2003 Cook D13/144

FOREIGN PATENT DOCUMENTS

GB 2094253 * 7/2000

* cited by examiner

Primary Examiner—Charles A. Rademaker

(74) *Attorney, Agent, or Firm*—Dillis V. Allen, Esq.

(57) **CLAIM**

The ornamental design for a handsfree accessory for phones,
as shown.

DESCRIPTION

FIG. 1 is a perspective view of a handsfree accessory for
phones showing our new design;
FIG. 2 is a left side elevation thereof;
FIG. 3 is a rear elevation thereof;
FIG. 4 is a front elevation thereof;
FIG. 5 is a top plan view thereof; and,
FIG. 6 is a bottom plan view thereof.

1 Claim, 2 Drawing Sheets

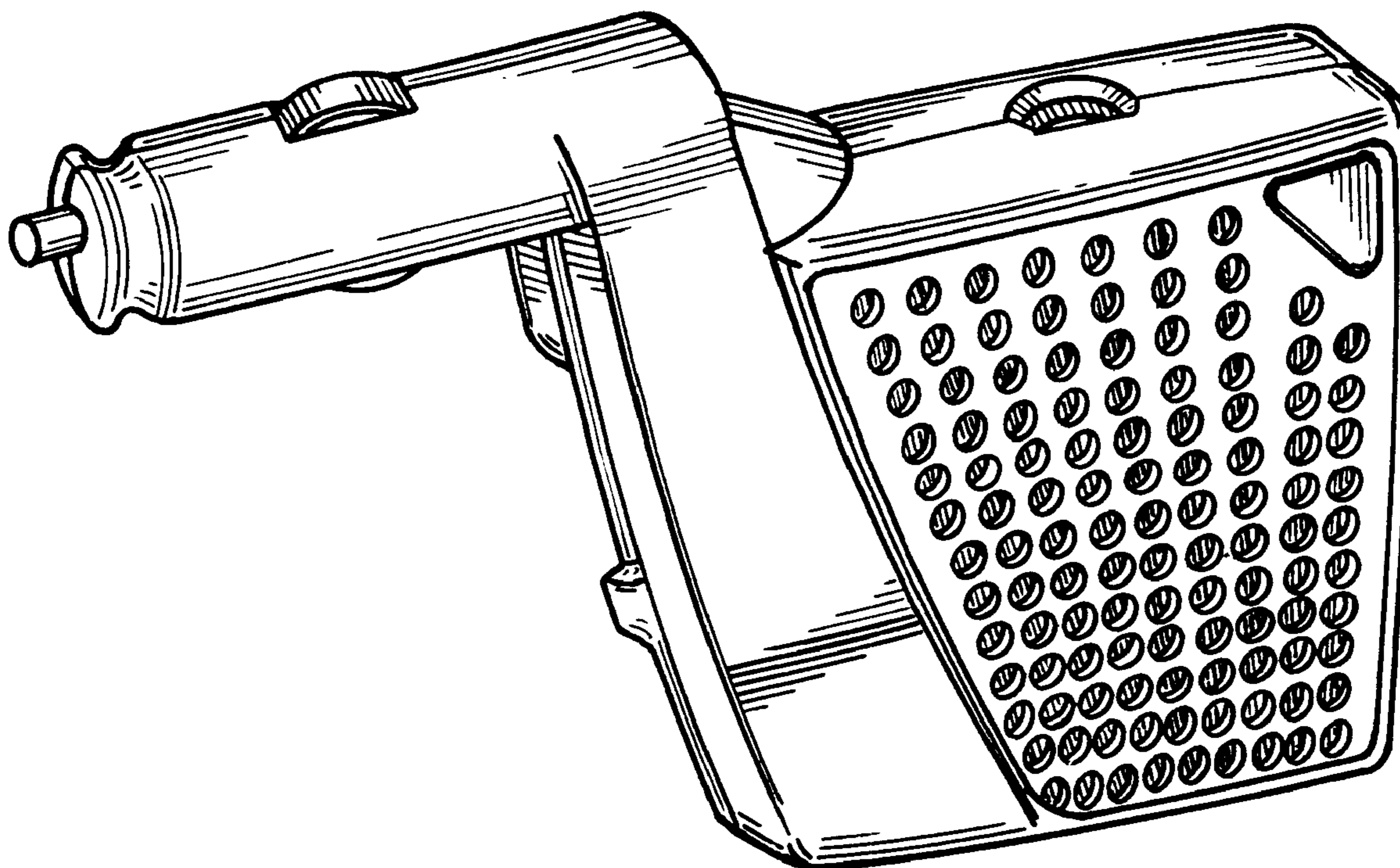

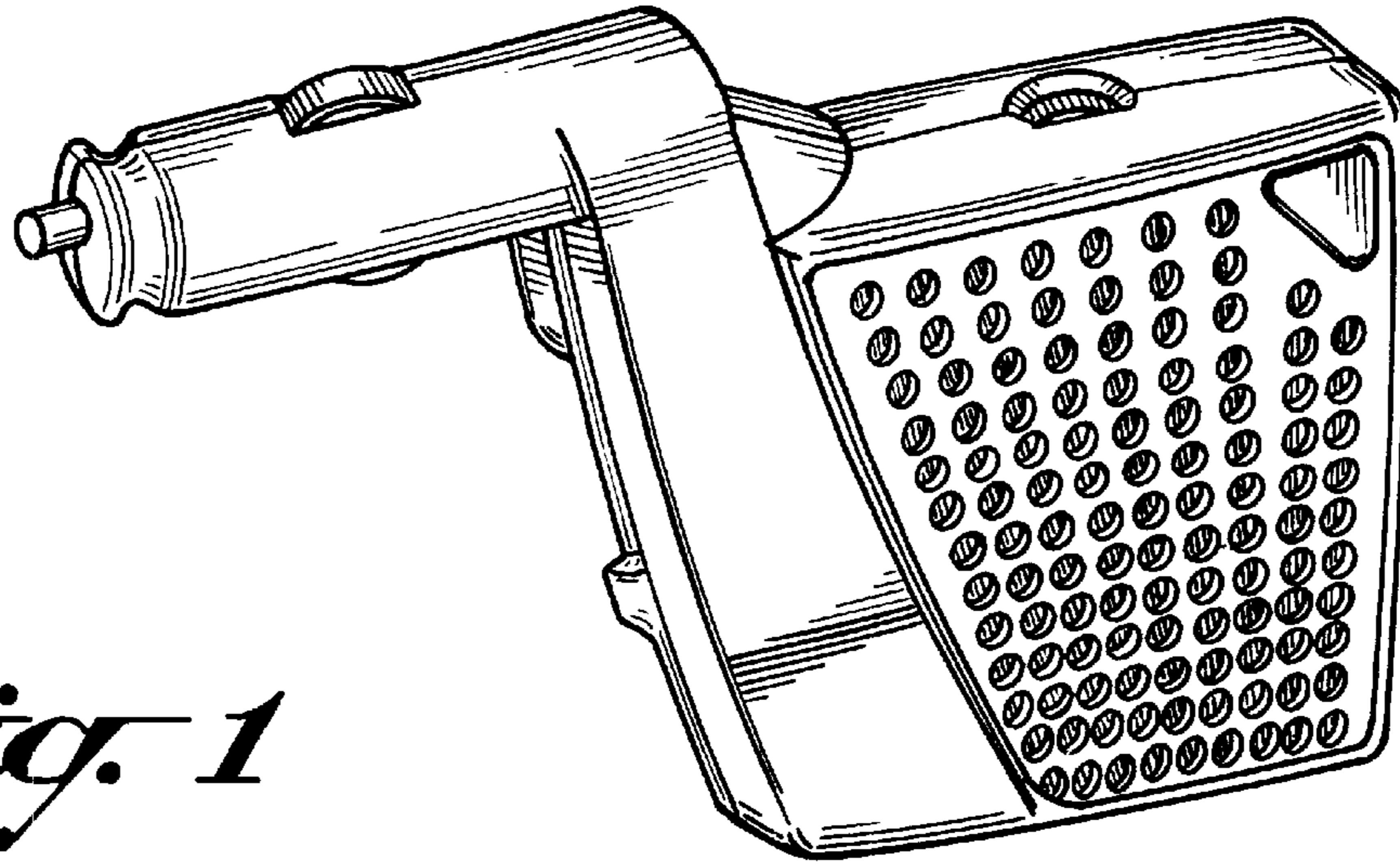

Fig. 1

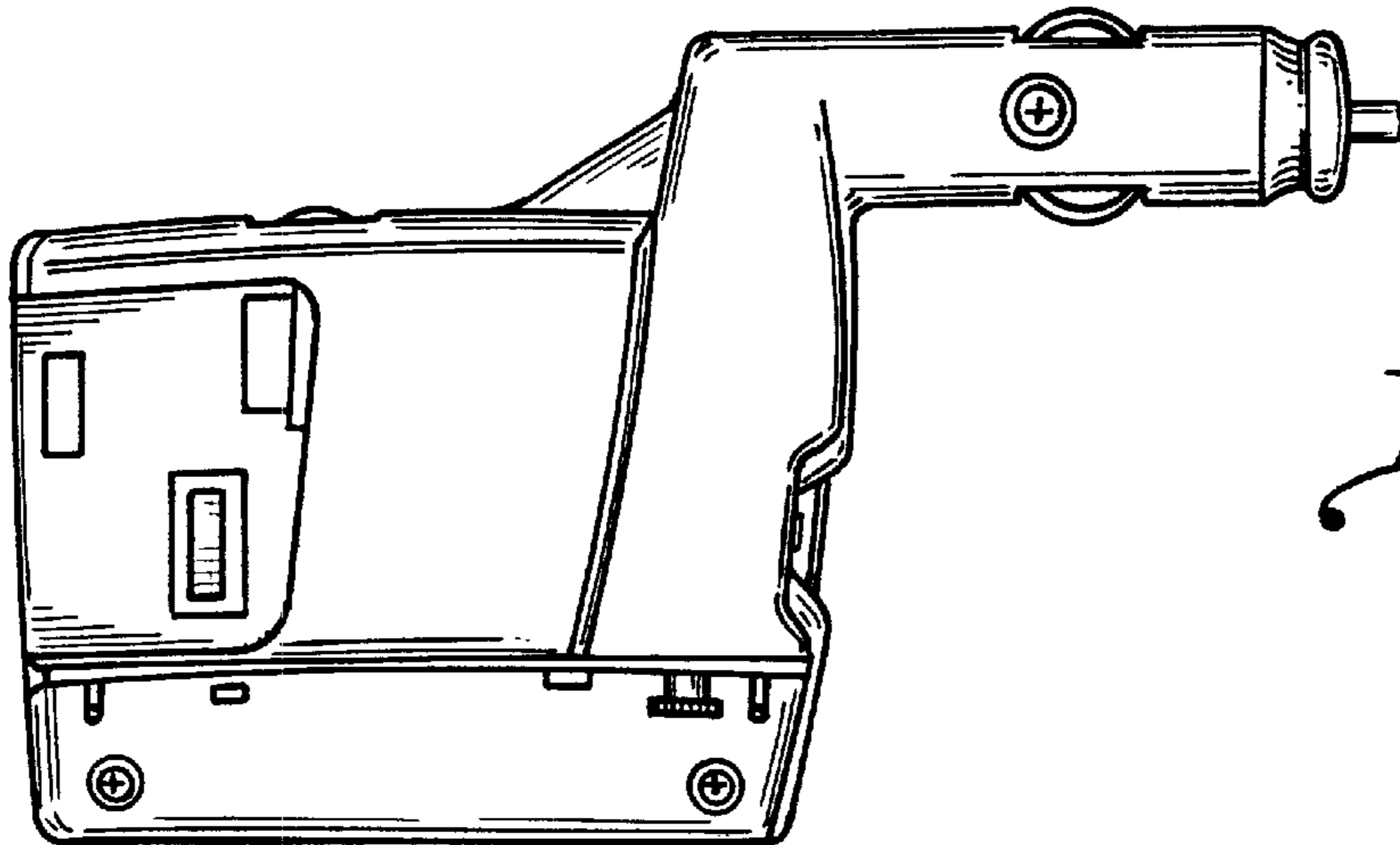
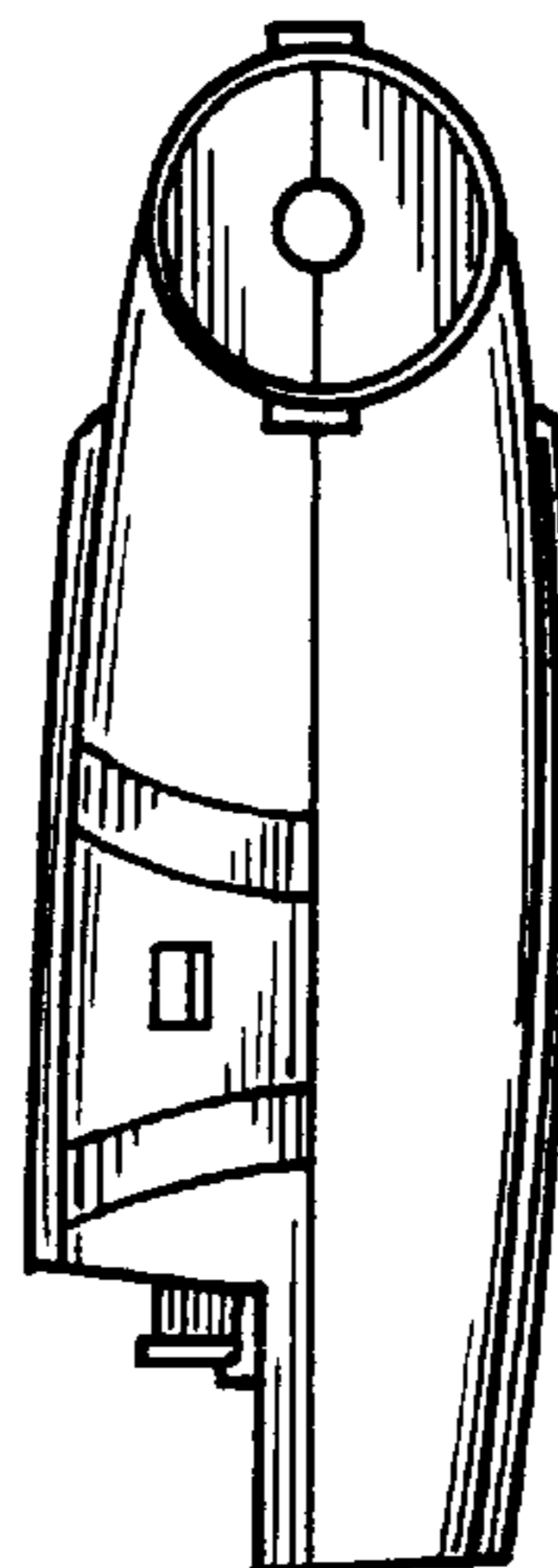

Fig. 2

Fig. 3



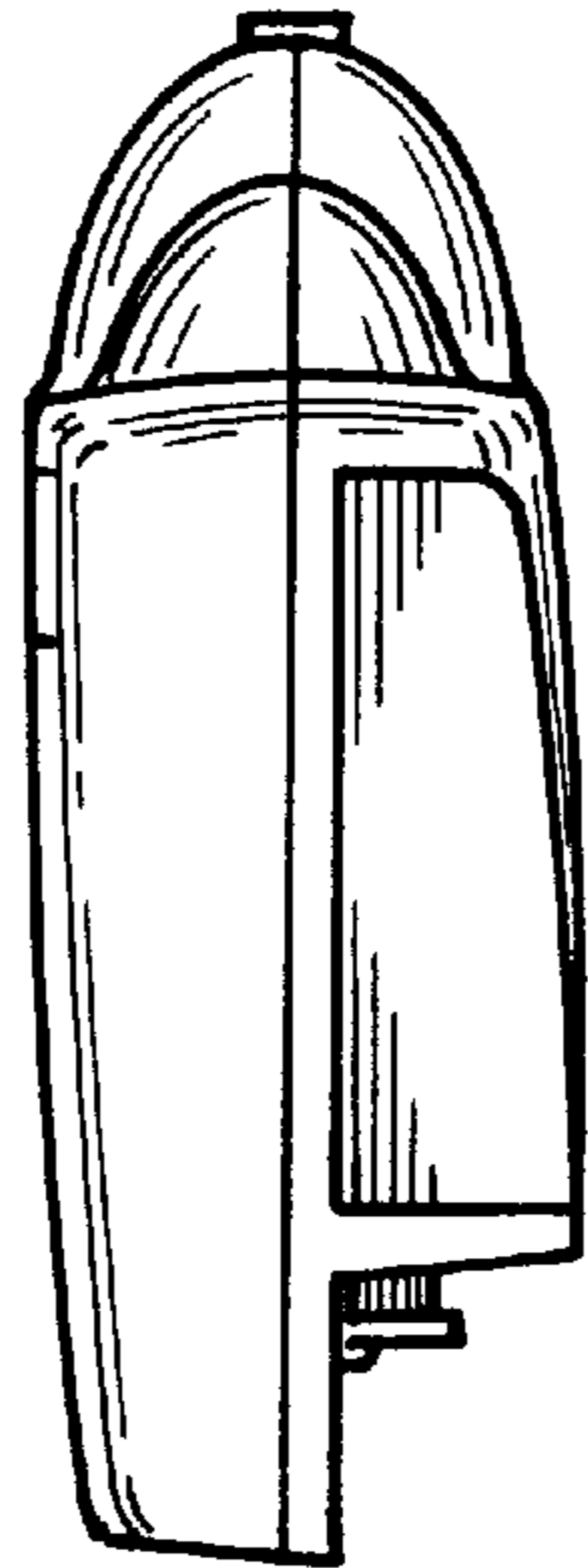

Fig. 4

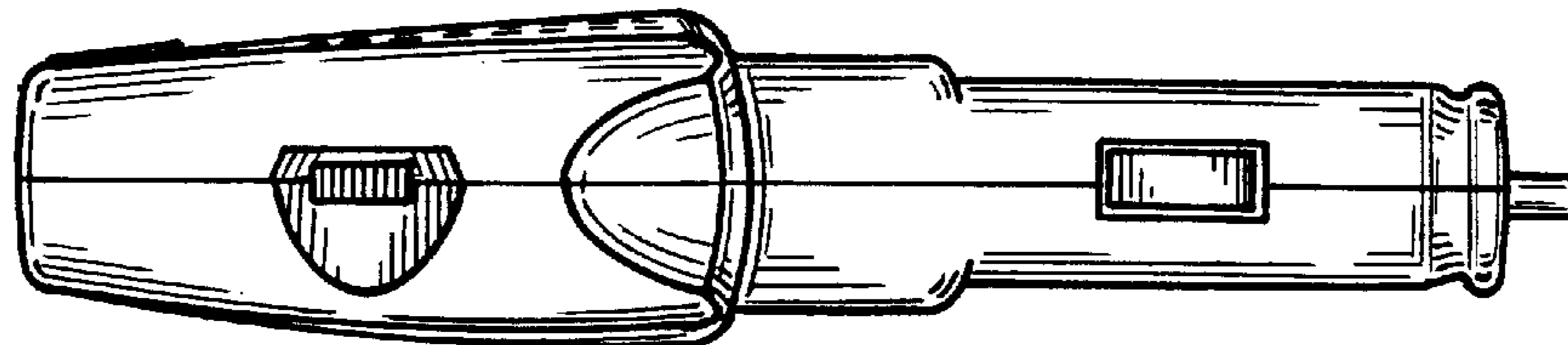

Fig. 5

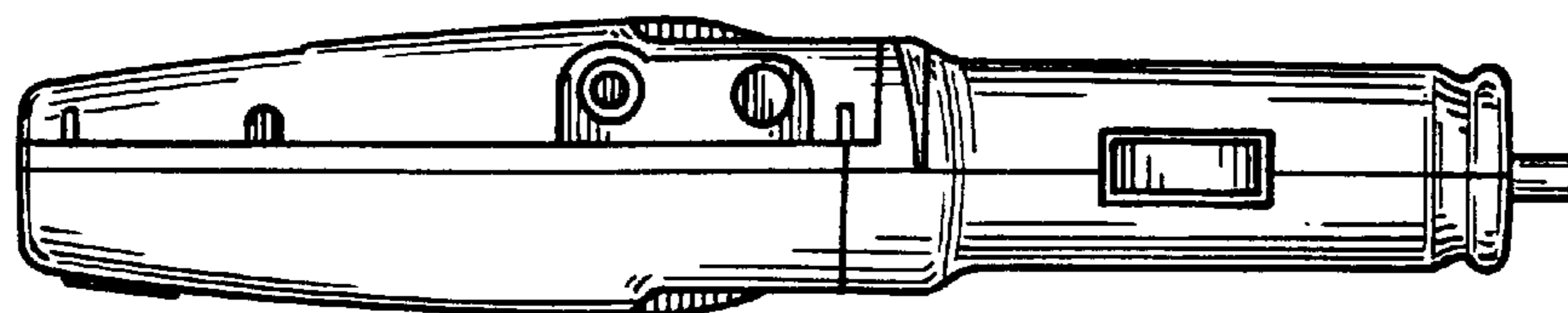

Fig. 6