

US00D509806S

(12) **United States Design Patent**
Lee et al.

(10) **Patent No.:** **US D509,806 S**
(45) **Date of Patent:** **** Sep. 20, 2005**

(54) **HEAT DISSIPATION DEVICE**

(75) Inventors: **Hsieh-Kun Lee**, Tu-Cheng (TW);
Xue-Wen Peng, Shenzhen (CN);
Rui-Hua Chen, Shenzhen (CN)

(73) Assignee: **Hon Hai Precision Industry Co., Ltd.**,
Taiwan (CN)

(**) Term: **14 Years**

(21) Appl. No.: **29/209,512**

(22) Filed: **Jul. 16, 2004**

(51) **LOC (8) Cl.** **13-03**

(52) **U.S. Cl.** **D13/179**

(58) **Field of Search** D13/179; 165/80.3,
165/121, 122, 146, 104.33, 180, 185; 174/16.3;
257/706, 707, 718, 722; 361/271, 274.3,
695, 697, 700, 702, 704, 709, 710, 711,
514, 719

(56) **References Cited**

U.S. PATENT DOCUMENTS

6,373,701 B1 * 4/2002 Lo 361/704
6,411,514 B1 * 6/2002 Hussaini 361/704
6,547,001 B2 * 4/2003 McCullough et al. 165/185
D484,468 S 12/2003 Lee et al.

D484,854 S * 1/2004 Lee D13/179
D484,855 S * 1/2004 Lee D13/179
D485,241 S * 1/2004 Lee D13/179

* cited by examiner

Primary Examiner—Stella Reid
Assistant Examiner—Selina Sikder

(74) *Attorney, Agent, or Firm*—Morris Manning & Martin;
Tim Tingkang Xia, Esq.

(57) **CLAIM**

The ornamental design for a heat dissipation device, as shown and described.

DESCRIPTION

FIG. 1 is a perspective view of a heat dissipation device of our new design;
FIG. 2 is a front elevational view thereof;
FIG. 3 is a rear elevational view thereof;
FIG. 4 is a left side elevational view thereof;
FIG. 5 is a right side elevational view thereof;
FIG. 6 is a top plan view thereof;
FIG. 7 is a bottom plan view thereof; and,
FIG. 8 is a perspective view thereof being mounted to a VGA card which is shown in broken lines for illustrative purposes only and forms no part of the claimed design.

1 Claim, 6 Drawing Sheets

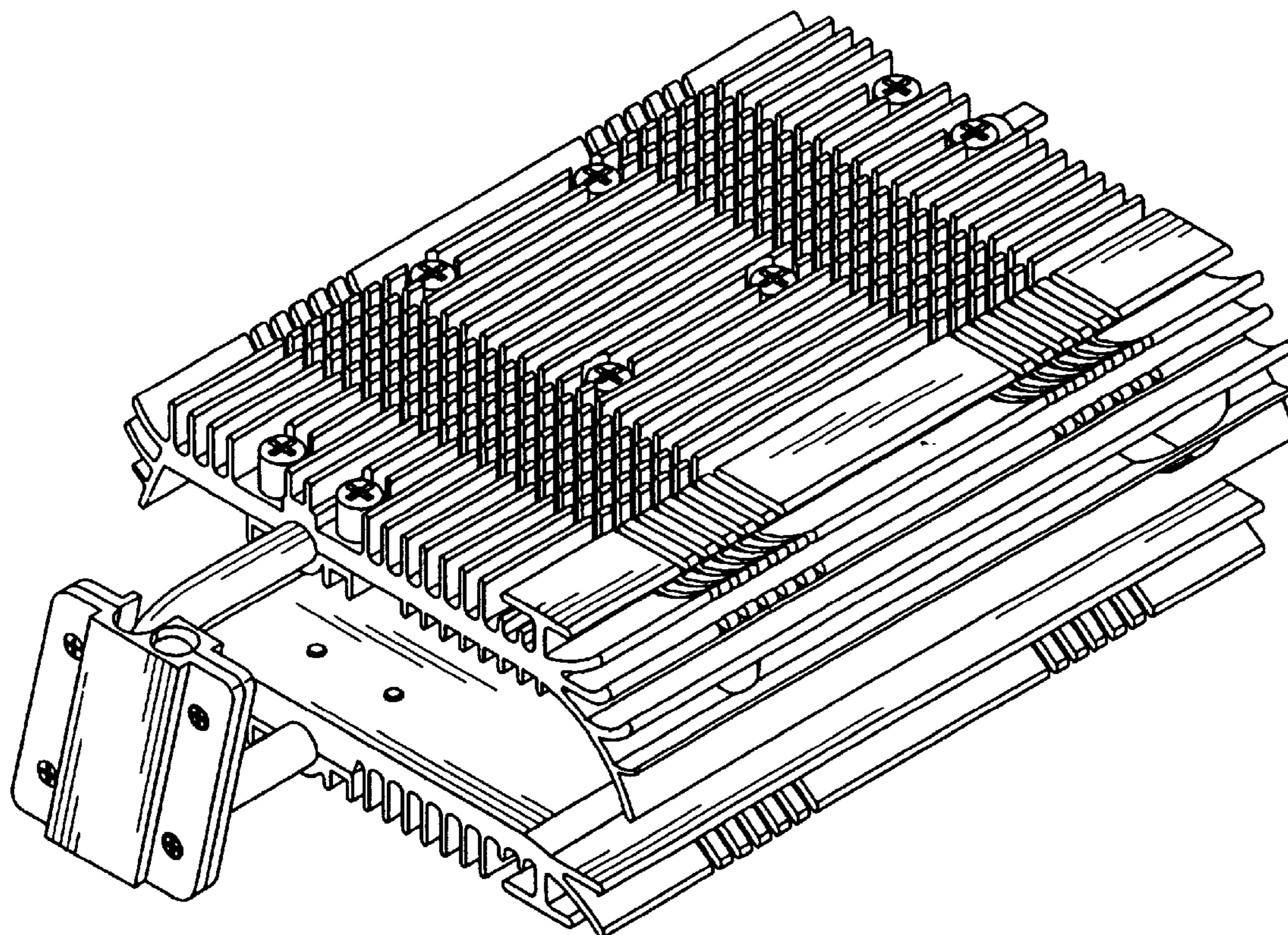

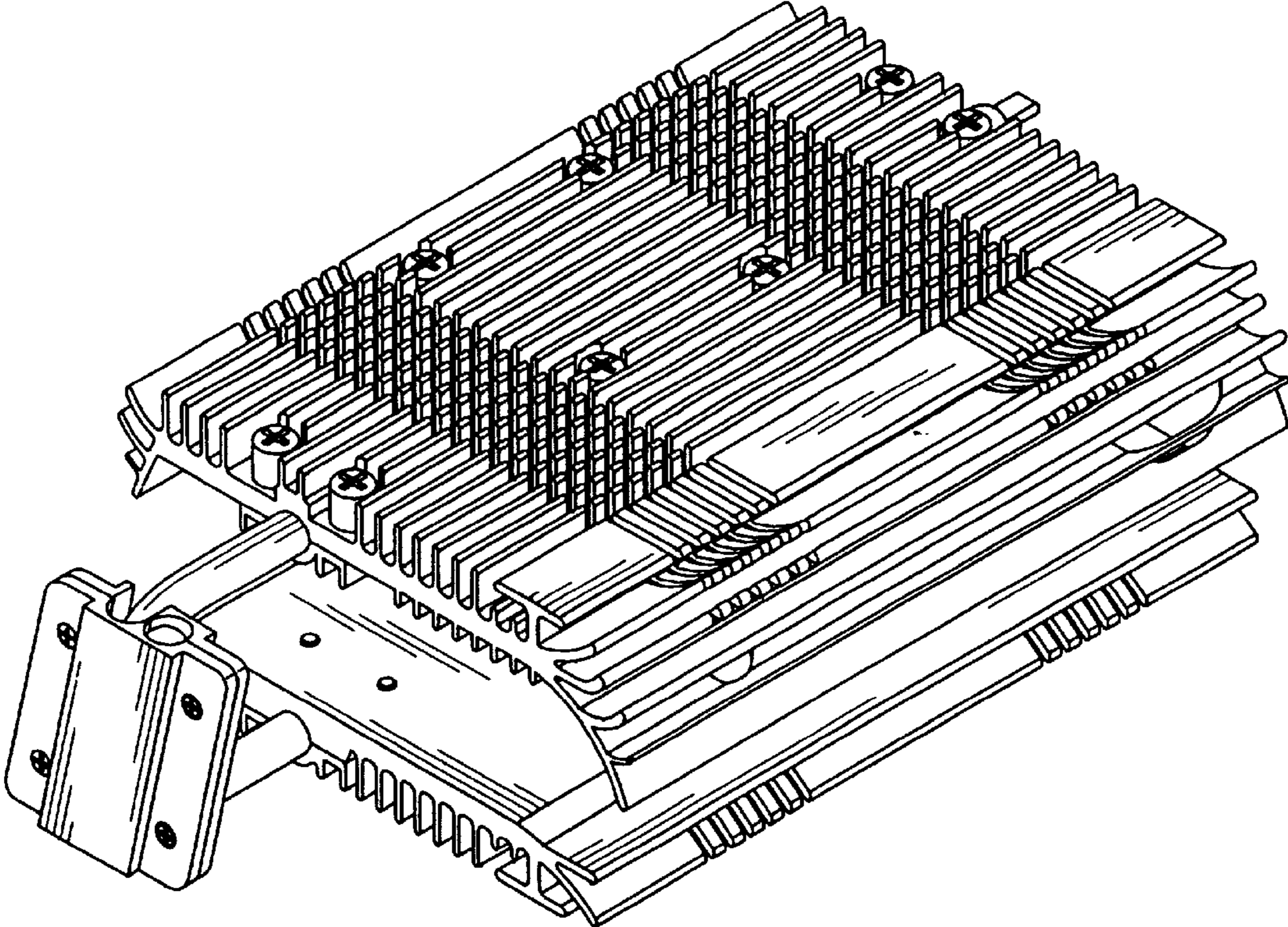

FIG. 1

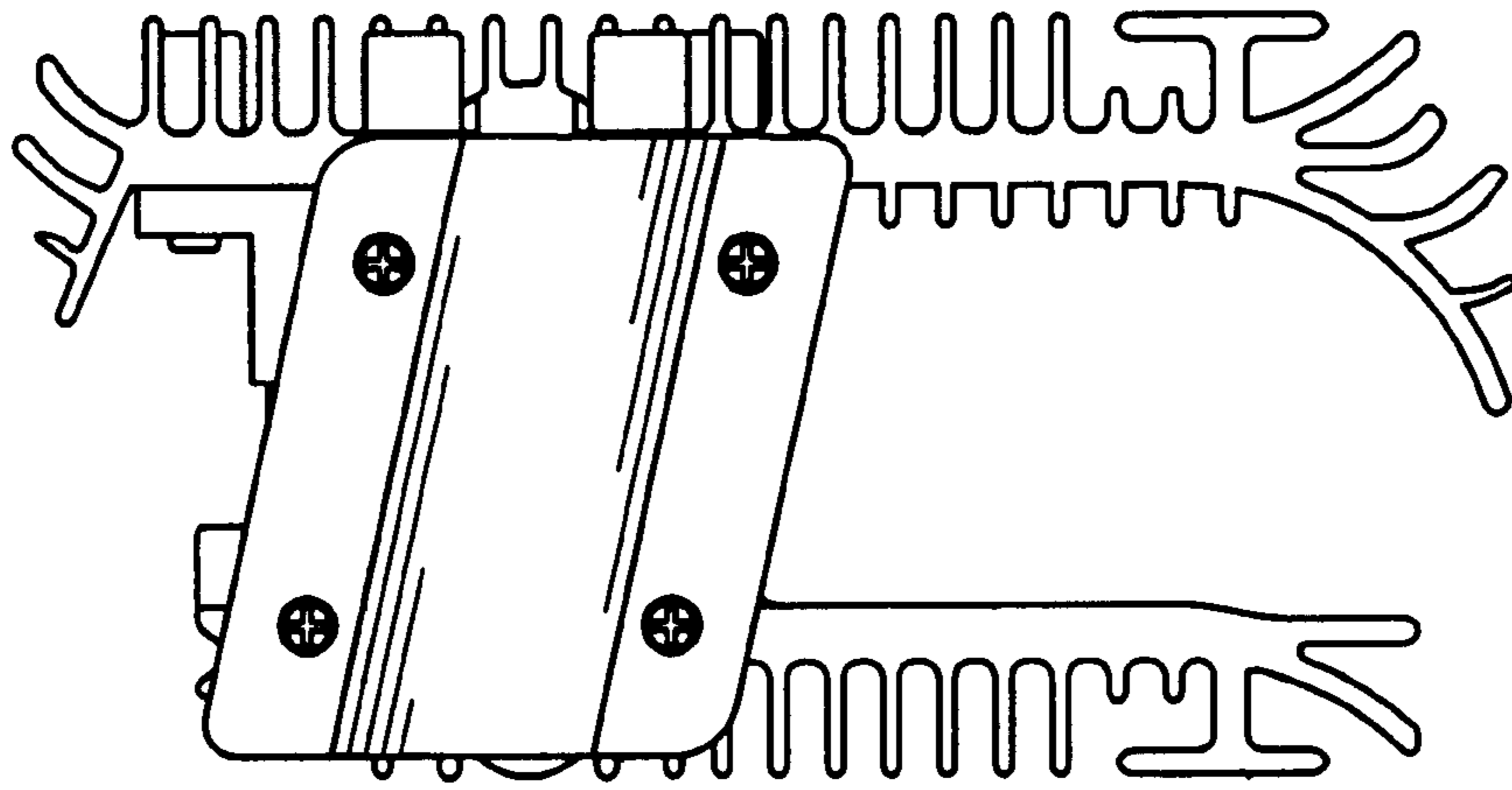

FIG. 2

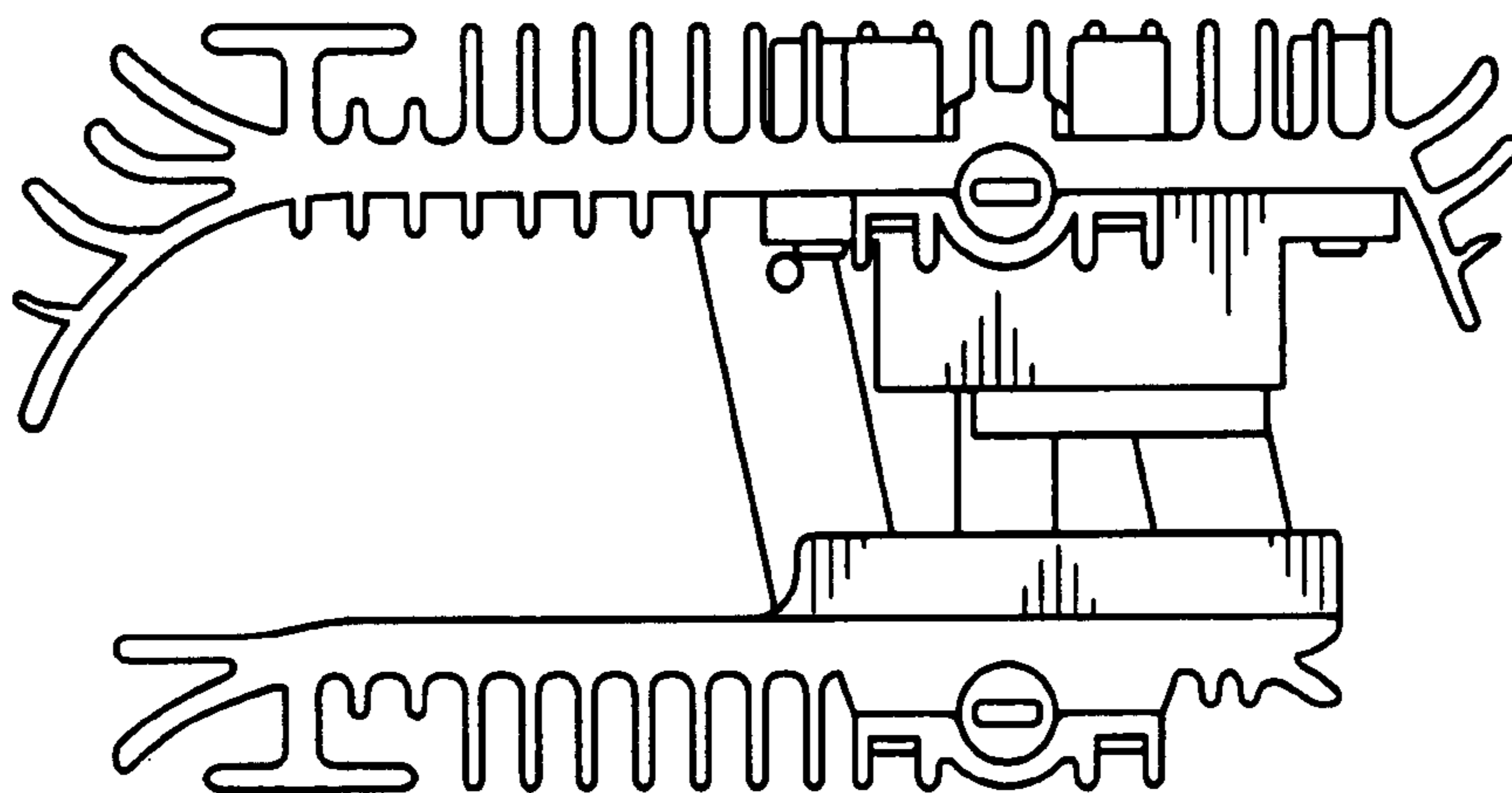

FIG. 3

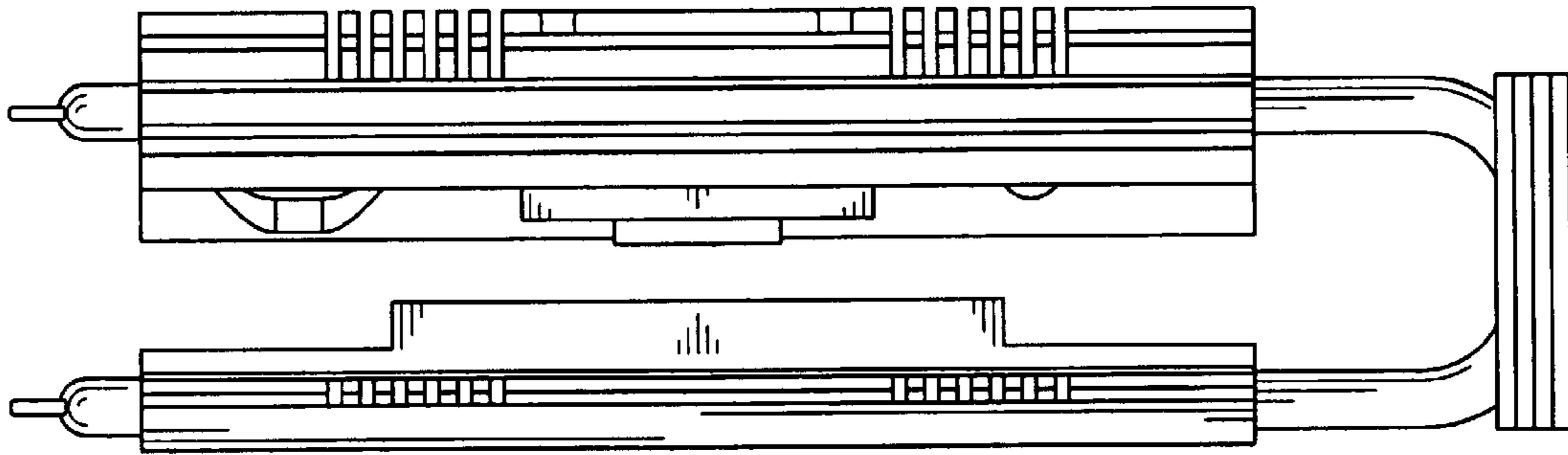

FIG. 4

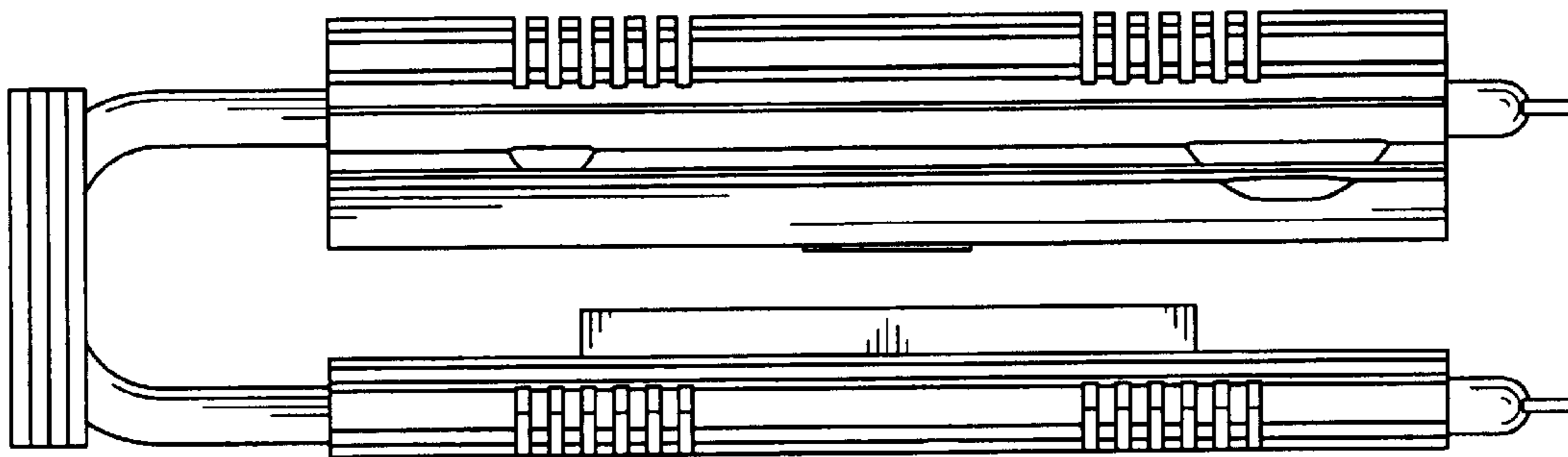

FIG. 5

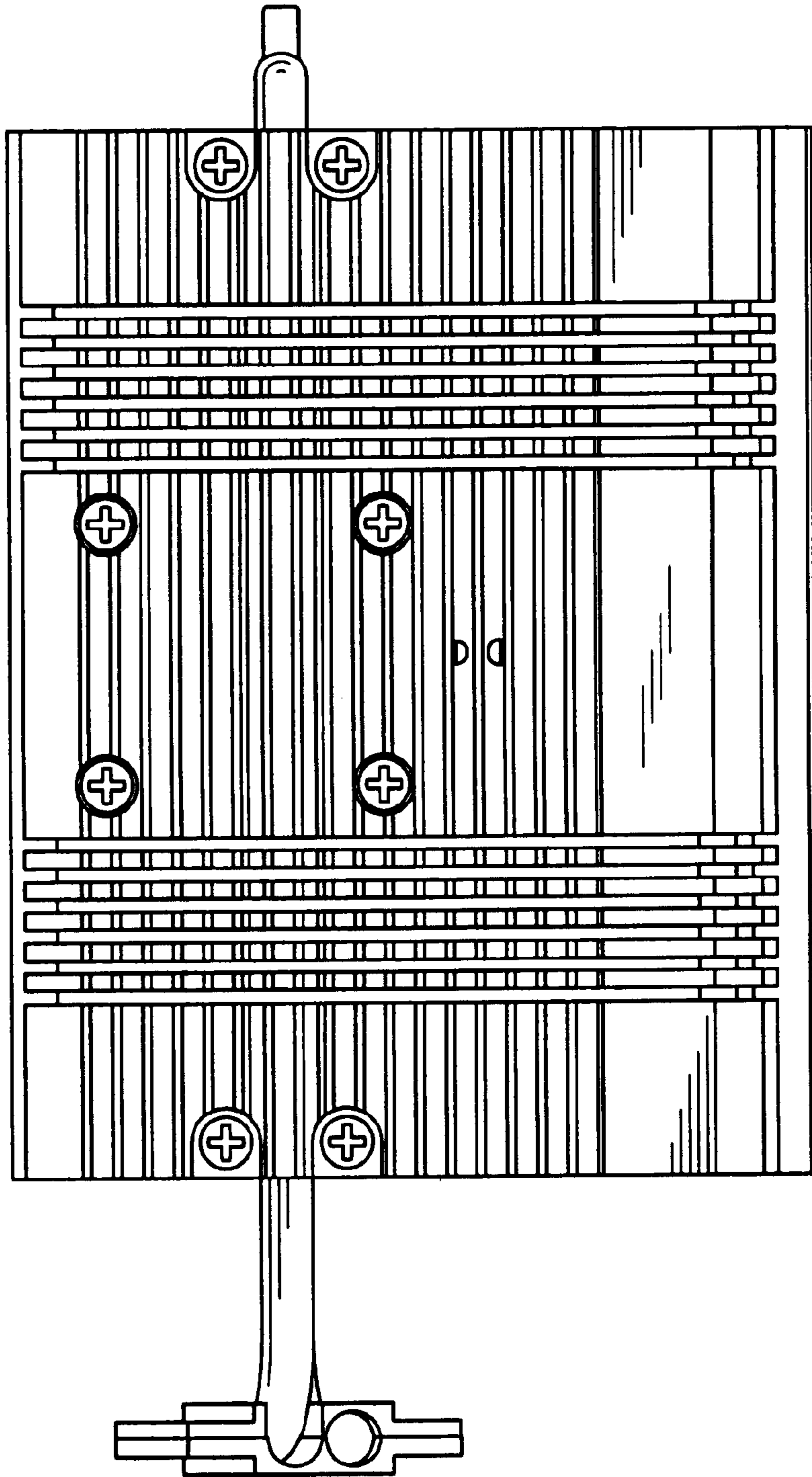

FIG. 6

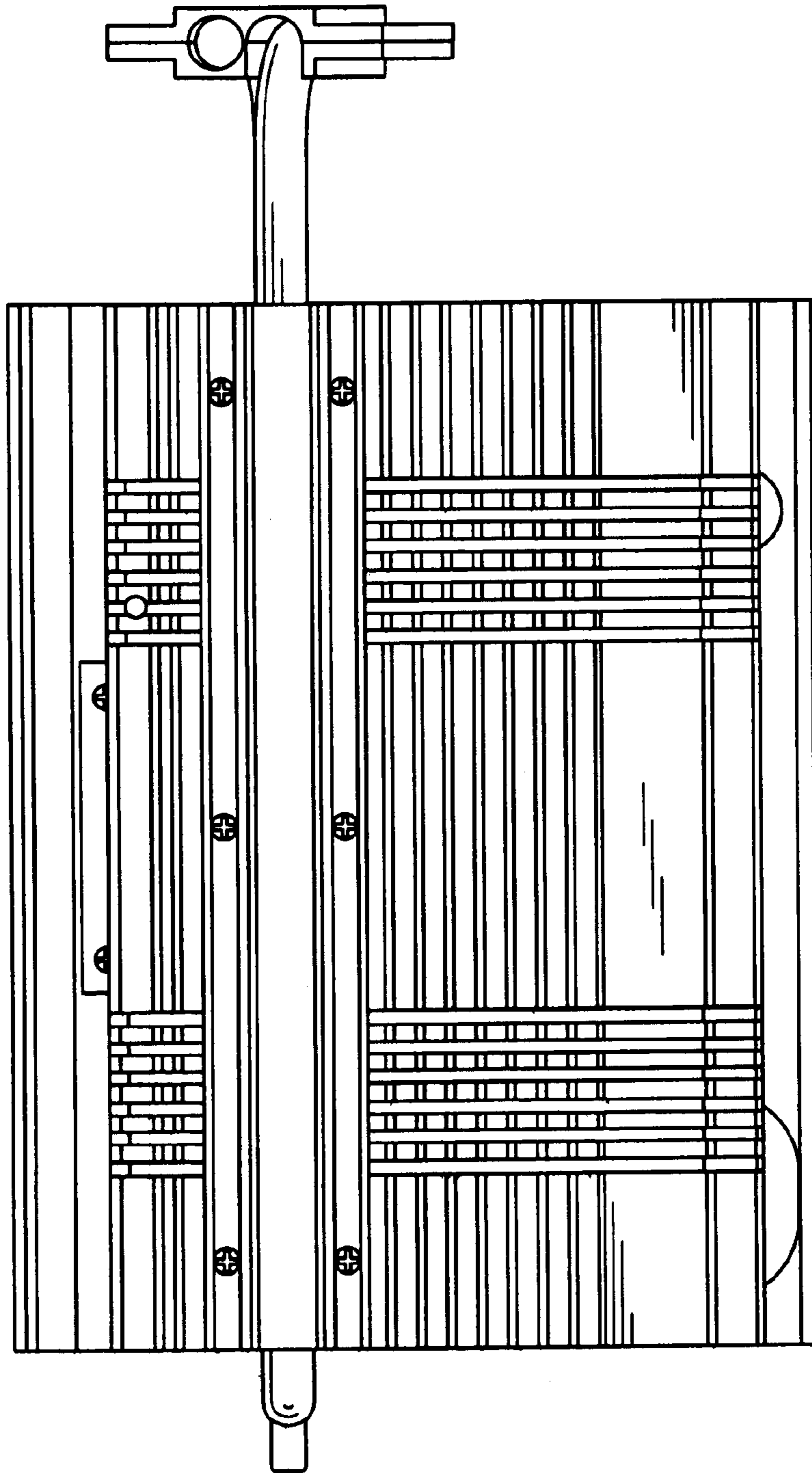

FIG. 7

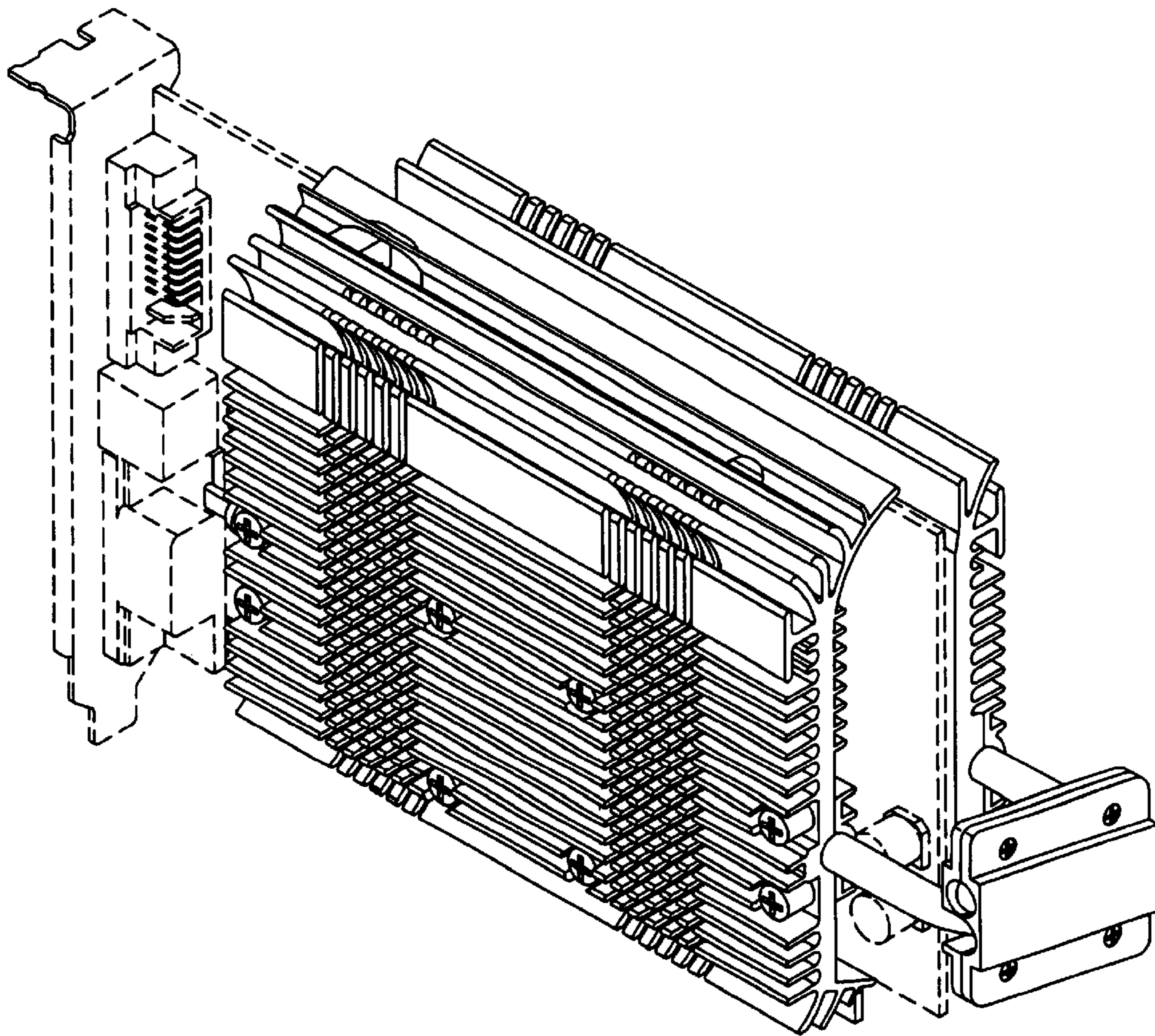

FIG. 8