



US00D509791S

(12) **United States Design Patent**  
**Dworschak**

(10) **Patent No.:** **US D509,791 S**

(45) **Date of Patent:** **\*\* Sep. 20, 2005**

(54) **ADAPTER**

(75) **Inventor:** **Alois Dworschak, Lüdenscheid (DE)**

(73) **Assignee:** **Erco Leuchten GmbH, Ludenscheid (DE)**

(\*\*) **Term:** **14 Years**

(21) **Appl. No.:** **29/182,416**

(22) **Filed:** **May 27, 2003**

(30) **Foreign Application Priority Data**

Dec. 6, 2002 (DE) ..... 4 02 10 133

(51) **LOC (8) Cl.** ..... **03-02**

(52) **U.S. Cl.** ..... **D13/110**

(58) **Field of Search** ..... D13/101, 107,  
D13/110, 123, 133, 146, 147, 184, 199;  
174/52.1, 59-60; 439/63, 578-585

(56) **References Cited**

**U.S. PATENT DOCUMENTS**

D291,303 S \* 8/1987 Wood et al. .... D13/133

D300,314 S \* 3/1989 Krzyzanowski et al. D13/137.3

D306,574 S \* 3/1990 Schultz ..... D13/103

D312,614 S \* 12/1990 Amachi et al. .... D13/133

D387,030 S \* 12/1997 Tracewell et al. .... D13/110

D424,017 S \* 5/2000 Lin ..... D13/133

D453,736 S \* 2/2002 Shimojyo ..... D13/147

D454,115 S \* 3/2002 Zemba ..... D13/147

D457,135 S \* 5/2002 Fong et al. .... D13/110

D458,903 S \* 6/2002 Ohbayashi et al. .... D13/147

D469,741 S \* 2/2003 Shimojo ..... D13/133

D493,138 S \* 7/2004 Jiang ..... D13/110

\* cited by examiner

*Primary Examiner*—Stella Reid

*Assistant Examiner*—Daniel Bui

(74) *Attorney, Agent, or Firm*—Herbert Dubno

(57) **CLAIM**

The ornamental design for an adapter, as shown.

**DESCRIPTION**

FIG. 1 is a front elevational view of an adapter showing my new design;

FIG. 2 is a rear elevational view thereof;

FIG. 3 is a left side elevational view thereof;

FIG. 4 is a right side elevational view thereof, with the sliding tab in an alternate position;

FIG. 5 is a bottom plan view thereof; and,

FIG. 6 is a top plan view thereof.

**1 Claim, 6 Drawing Sheets**

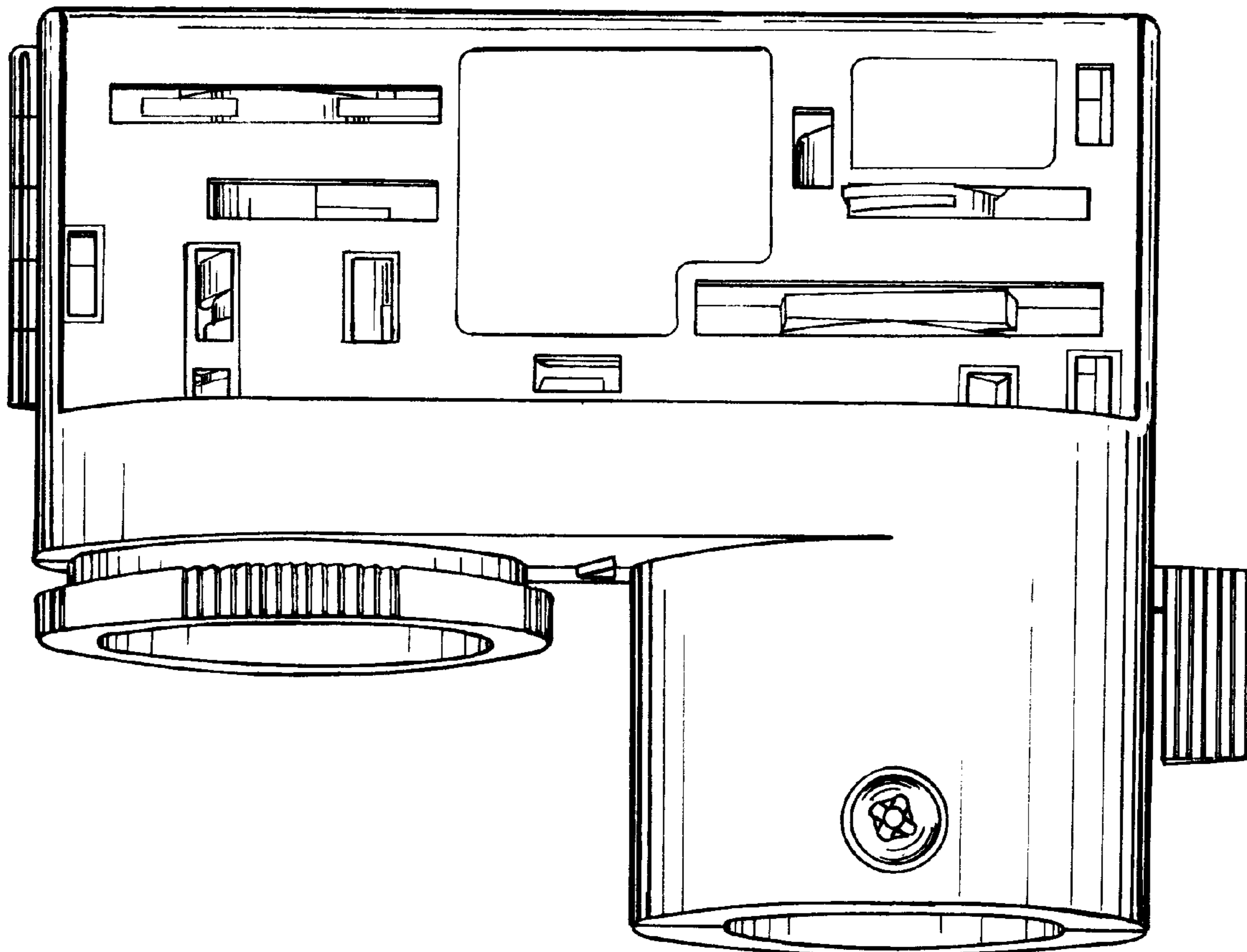

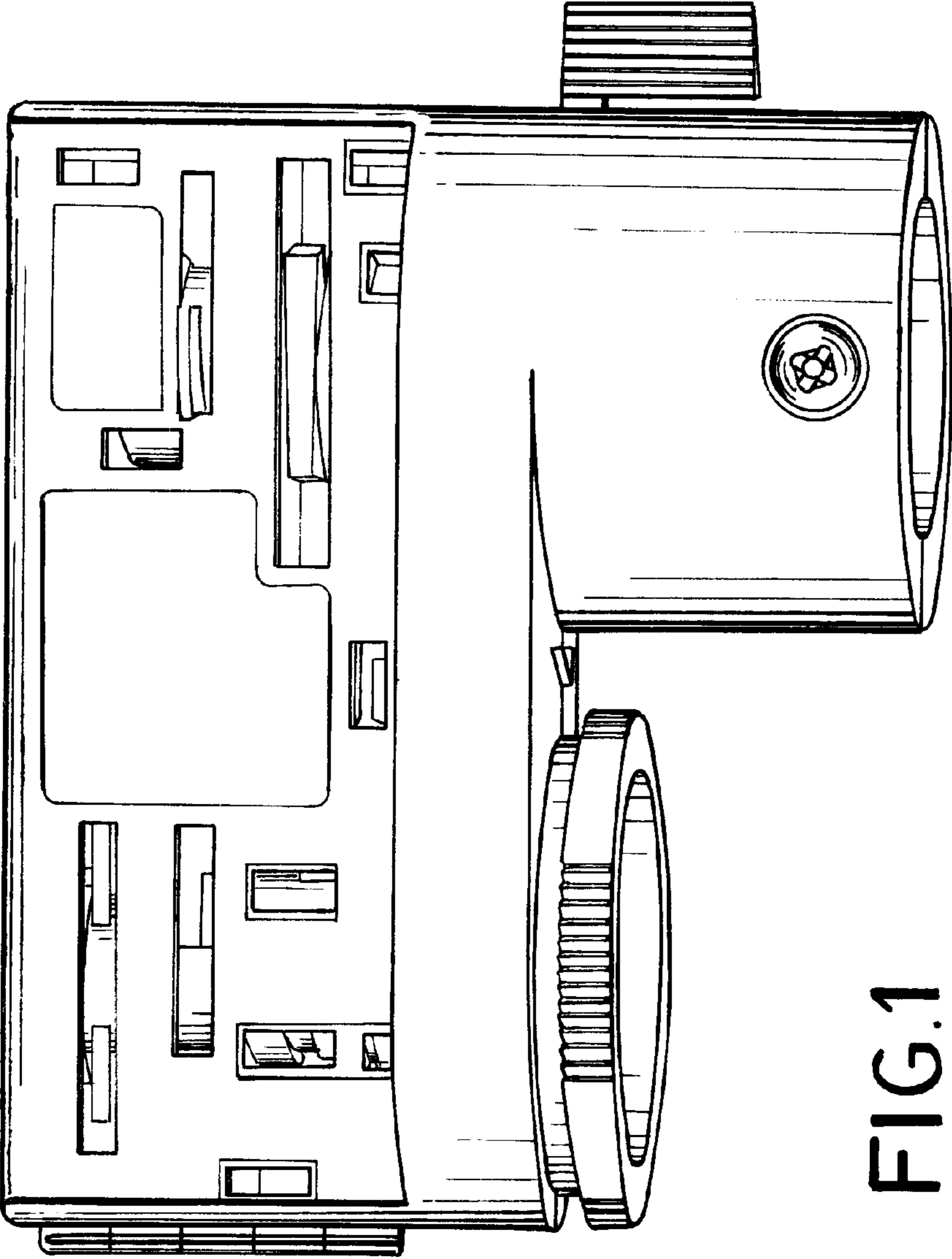

FIG.1

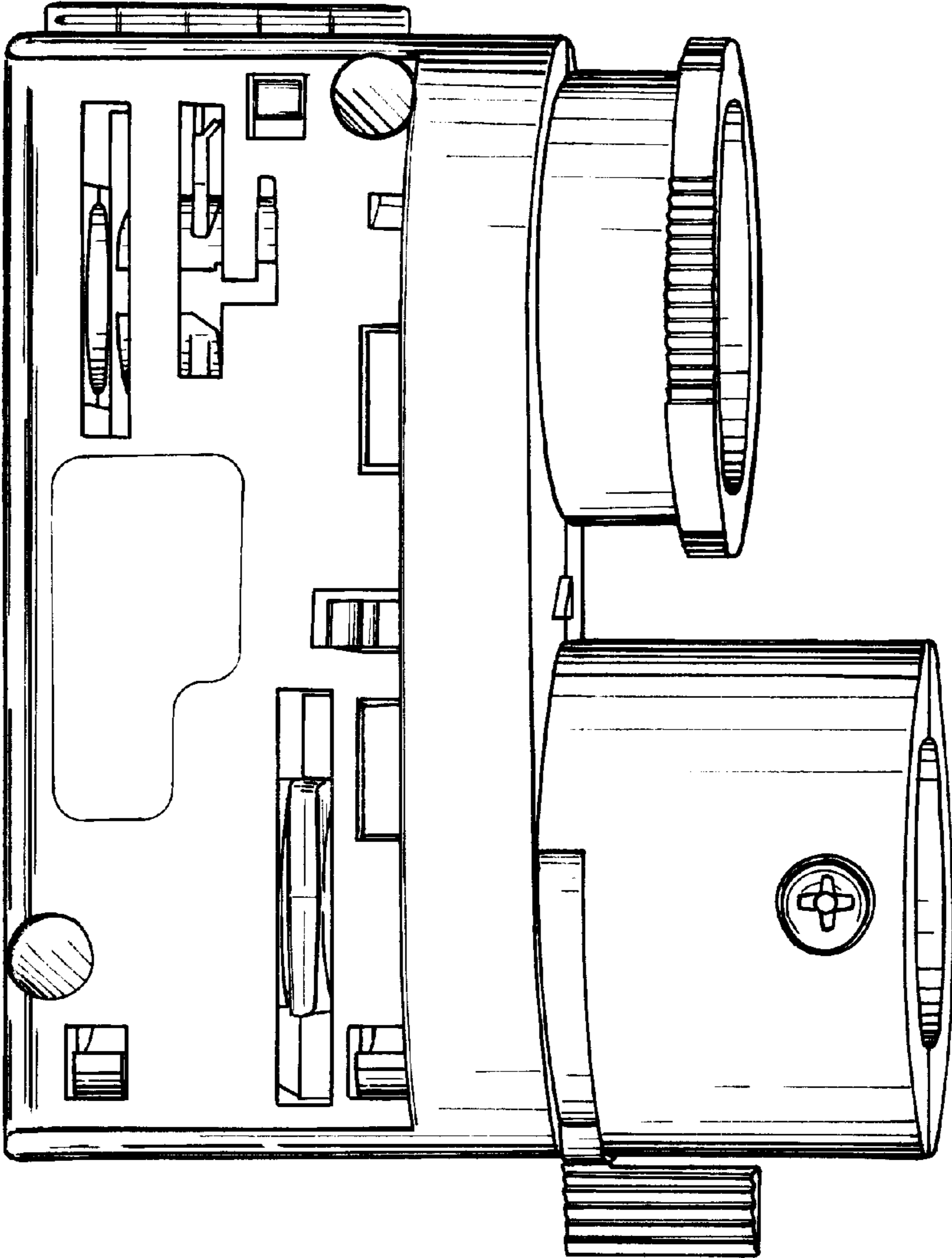

FIG.2

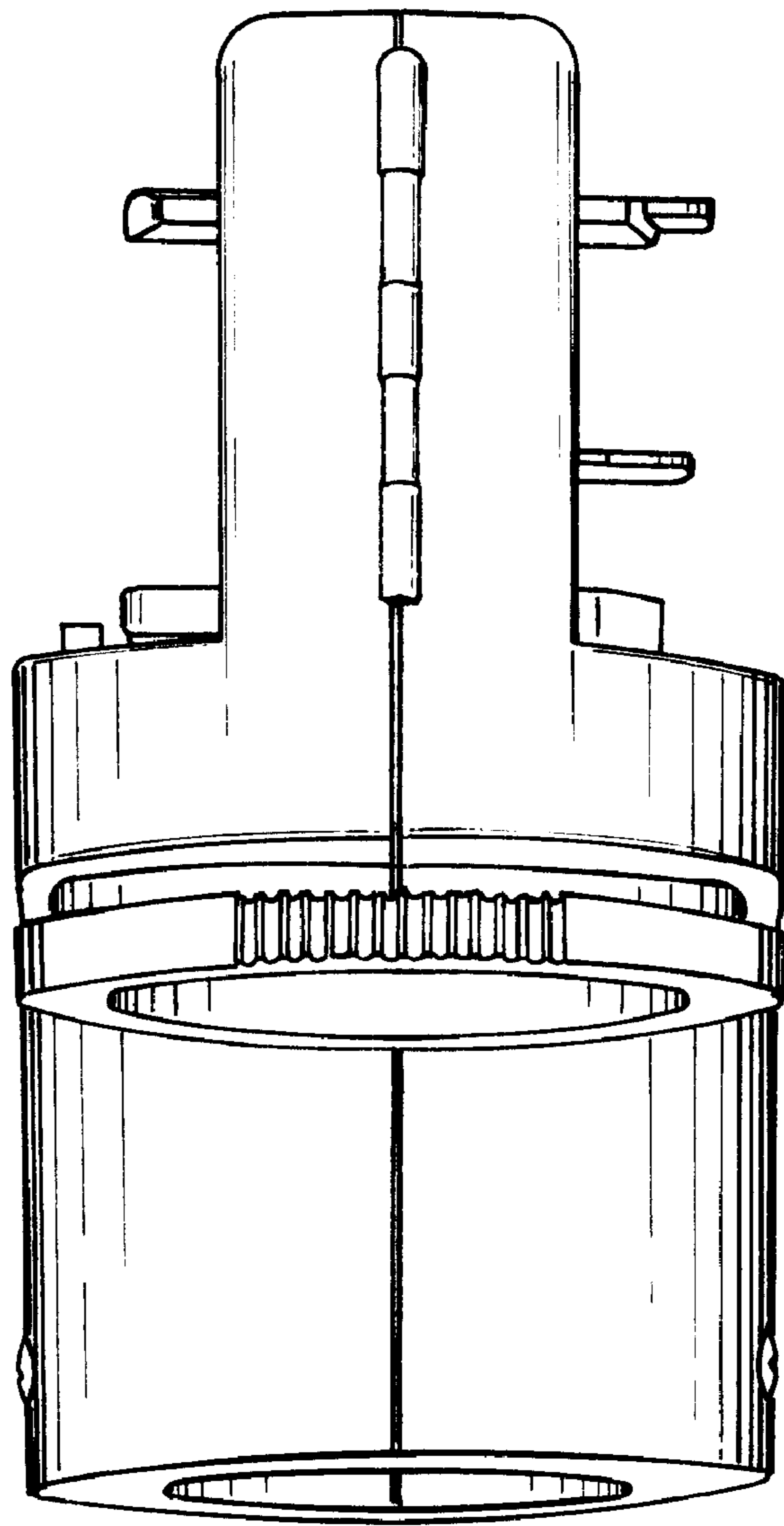

FIG.3

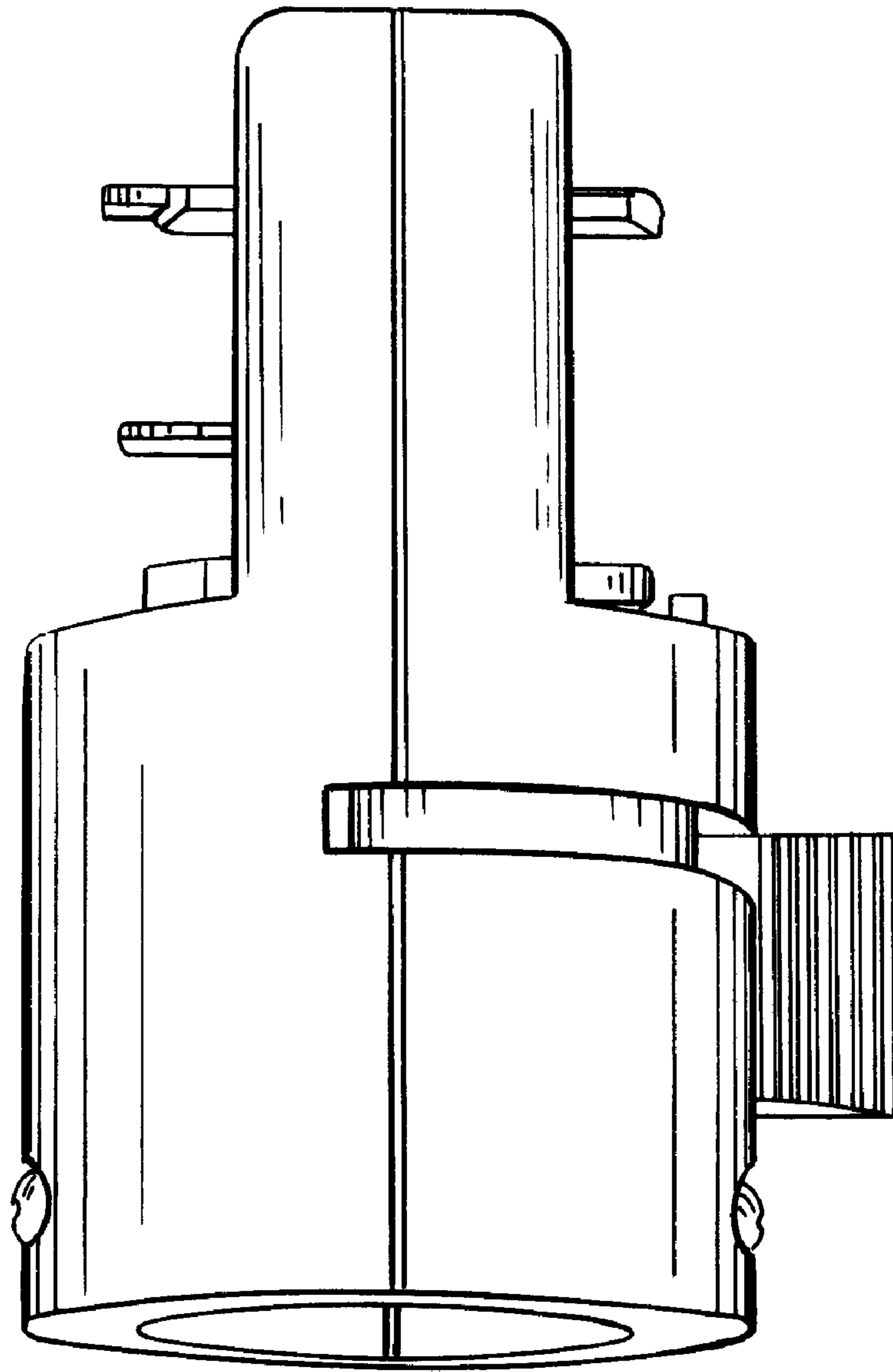

FIG.4

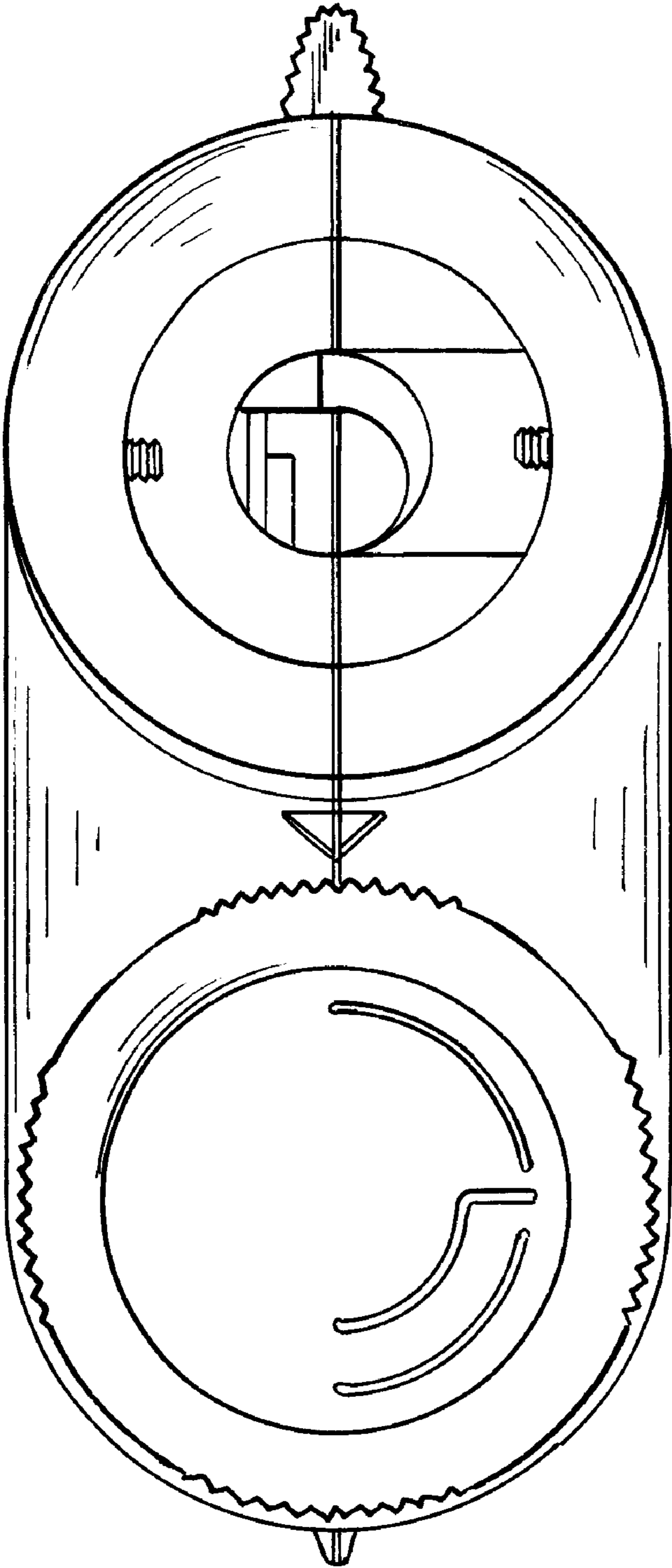

FIG. 5

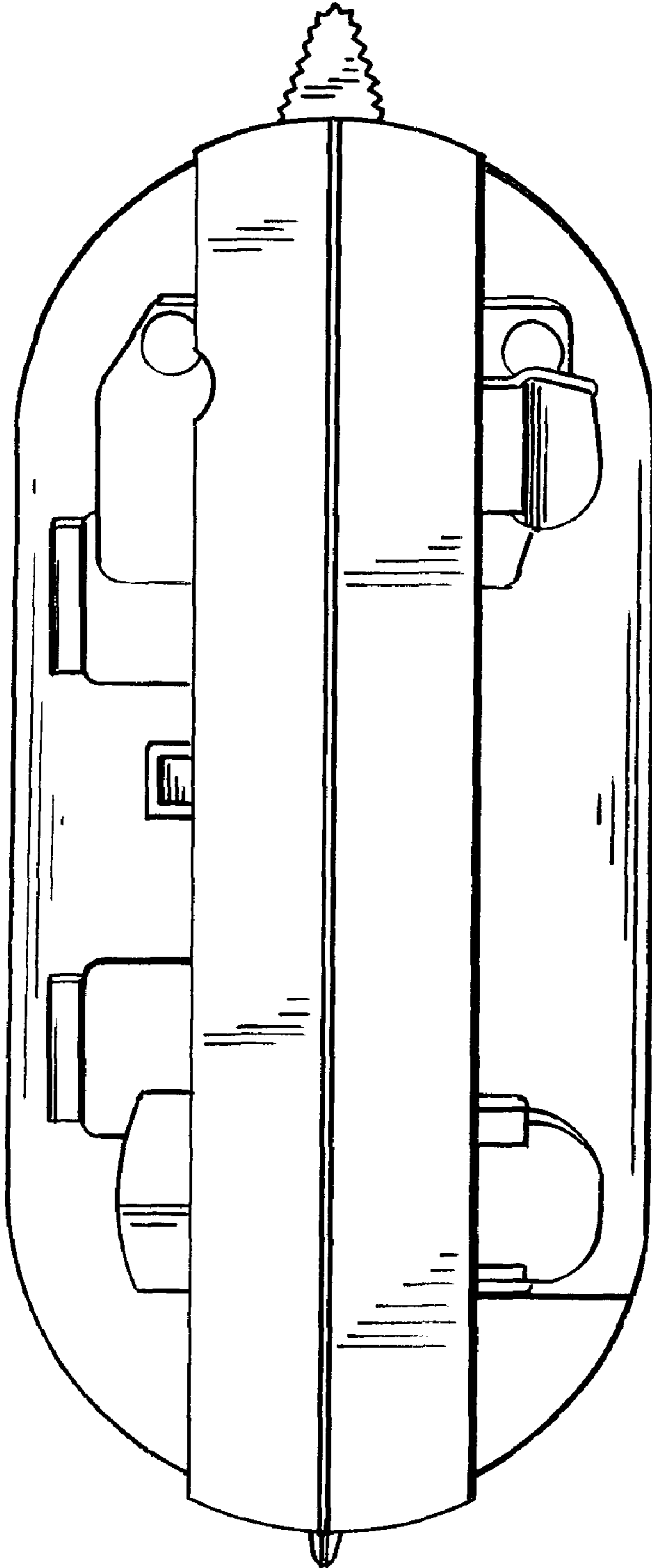

FIG. 6