

US00D509770S

(12) **United States Design Patent** (10) **Patent No.:** **US D509,770 S**
Hamada et al. (45) **Date of Patent:** **** Sep. 20, 2005**

(54) **SLIDER FOR SLIDE FASTENER**
(75) Inventors: **Yoshikazu Hamada**, Toyama-Ken (JP);
Yuichi Iwase, Toyama-Ken (JP);
Keiichi Keyaki, Toyama-Ken (JP);
Kentaro Yamamoto, Toyama-Ken (JP)

(73) Assignee: **YKK Corporation**, Tokyo (JP)

(**) Term: **14 Years**

(21) Appl. No.: **29/199,926**

(22) Filed: **Feb. 19, 2004**

(30) **Foreign Application Priority Data**

Aug. 19, 2003 (JP) 2003-023925
Aug. 19, 2003 (JP) 2003-023927

(51) **LOC (8) Cl.** **02-07**

(52) **U.S. Cl.** **D11/221**

(58) **Field of Search** D11/200, 201,
D11/221; 24/415-417, 419, 421, 427-431,
381-382, 385, 387, 433

(56) **References Cited**

U.S. PATENT DOCUMENTS

D484,829 S * 1/2004 Yamamoto et al. D11/221
D497,570 S * 10/2004 Iwase D11/221

* cited by examiner

Primary Examiner—Ralf Seifert
(74) *Attorney, Agent, or Firm*—Michael S. Leonard;
Everest Intellectual Property Law Group

(57) **CLAIM**

We claim the ornamental design for a slider for slide fastener, as shown and described.

DESCRIPTION

FIG. 1 is a front elevational view of a slider for slide fastener of the claimed design.

FIG. 2 is a rear elevational view of the slider for slide fastener of FIG. 1.

FIG. 3 is a top plan view of the slider for slide fastener of FIG. 1.

FIG. 4 is a bottom plan view of the slider for slide fastener of FIG. 1.

FIG. 5 is a right side elevational view of the slider for slide fastener of FIG. 1, the left side view being a mirror image.

FIG. 6 is a perspective view of the slider for slide fastener of FIG. 1.

FIG. 7 is a front elevational view of a slider for slide fastener showing a second embodiment of my new design;

FIG. 8 is rear elevational view of FIG. 7;

FIG. 9 is a top plan view of FIG. 7;

FIG. 10 is a bottom plan view of FIG. 7;

FIG. 11 is a right side elevational view of FIG. 7; and,

FIG. 12 is a perspective view of FIG. 7.

1 Claim, 6 Drawing Sheets

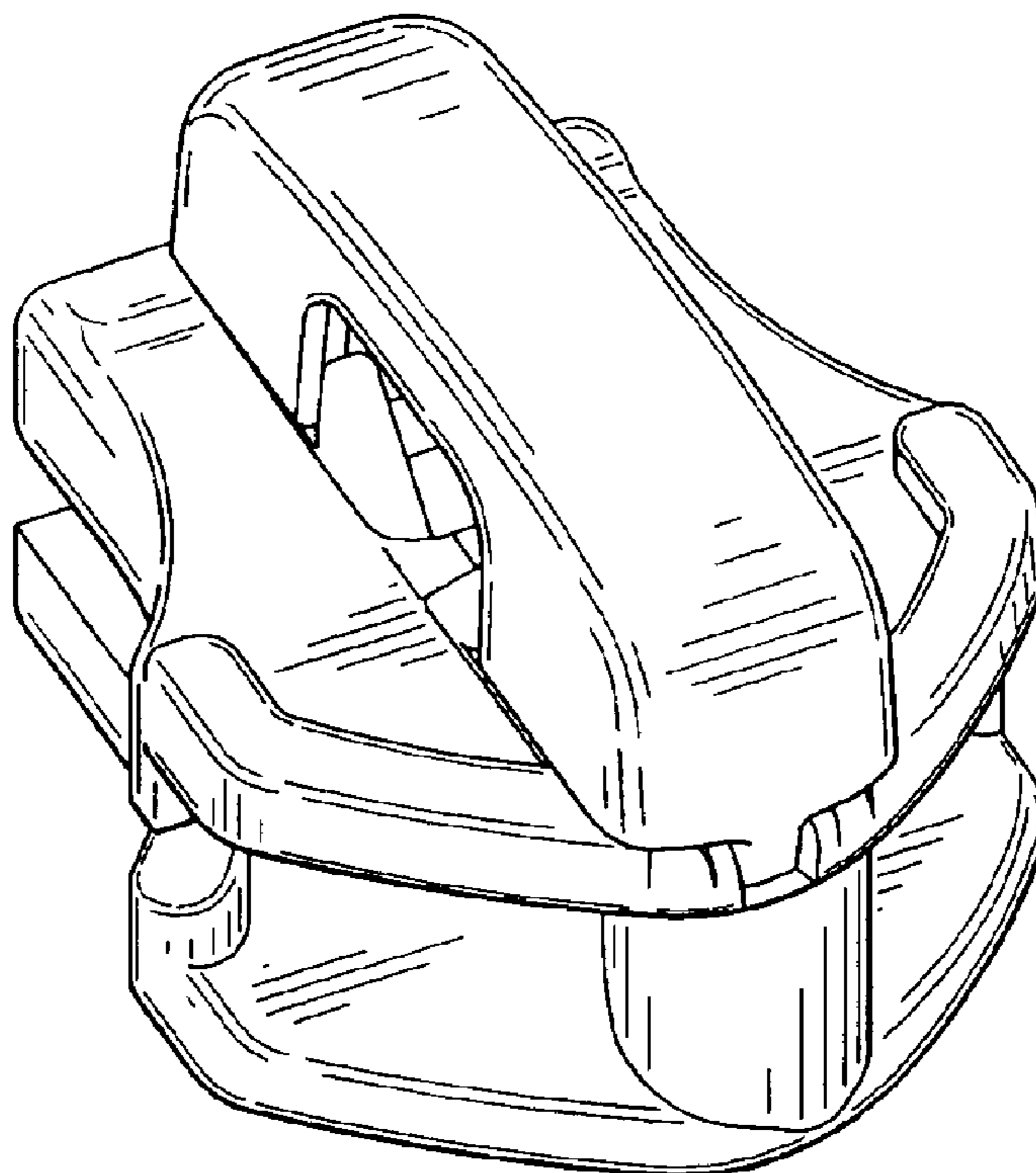

FIG.1

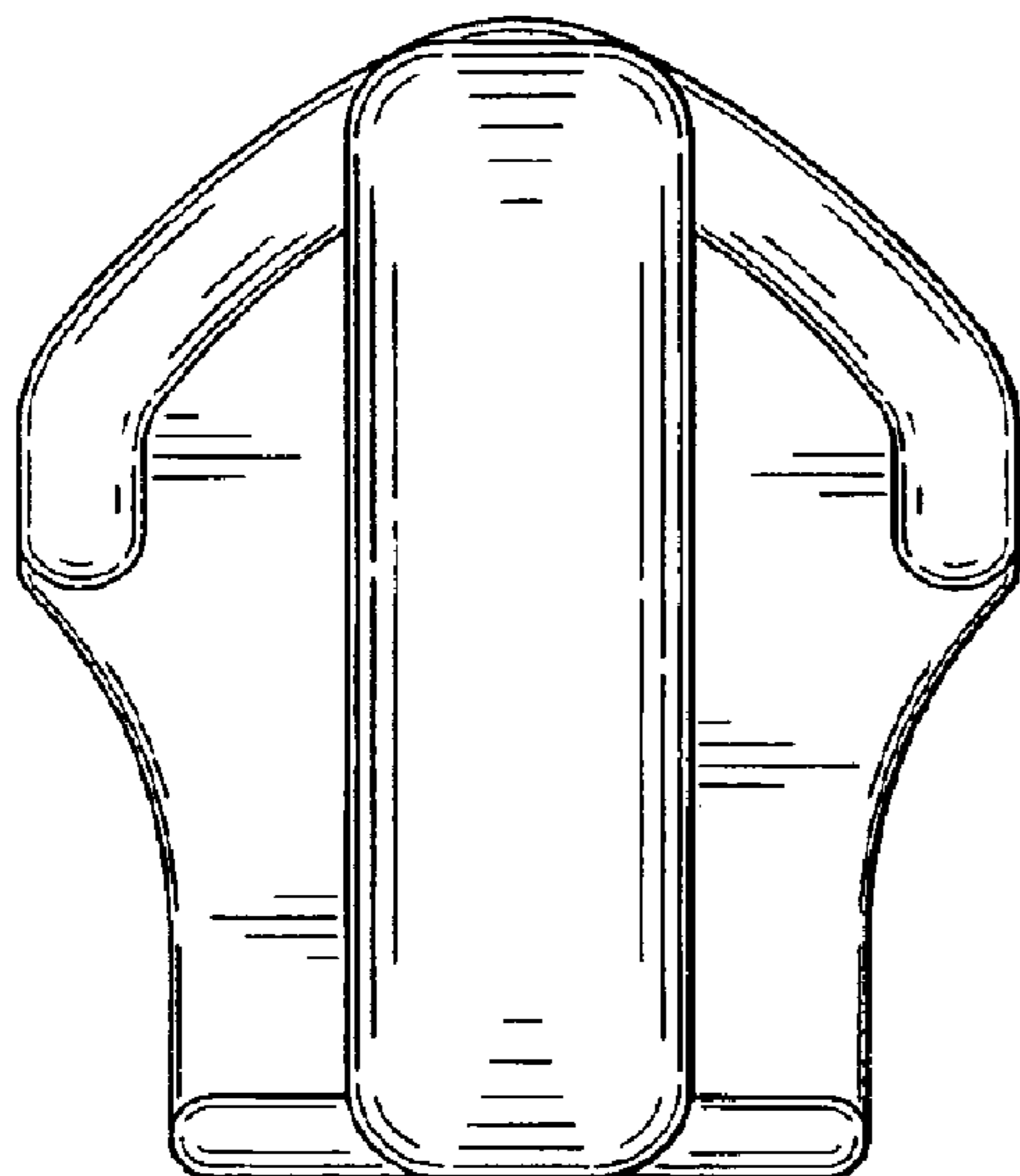

FIG.2

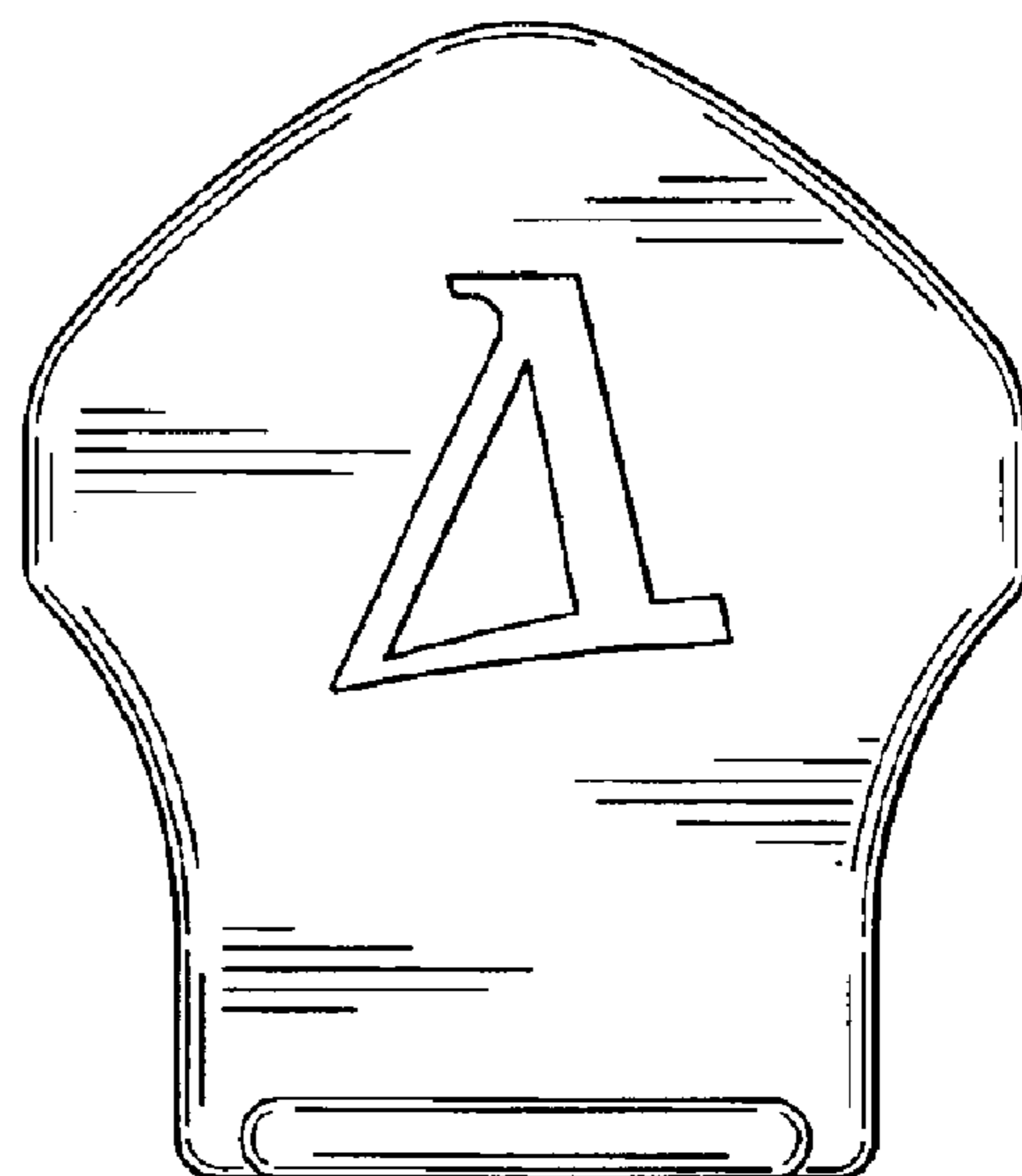

FIG.3

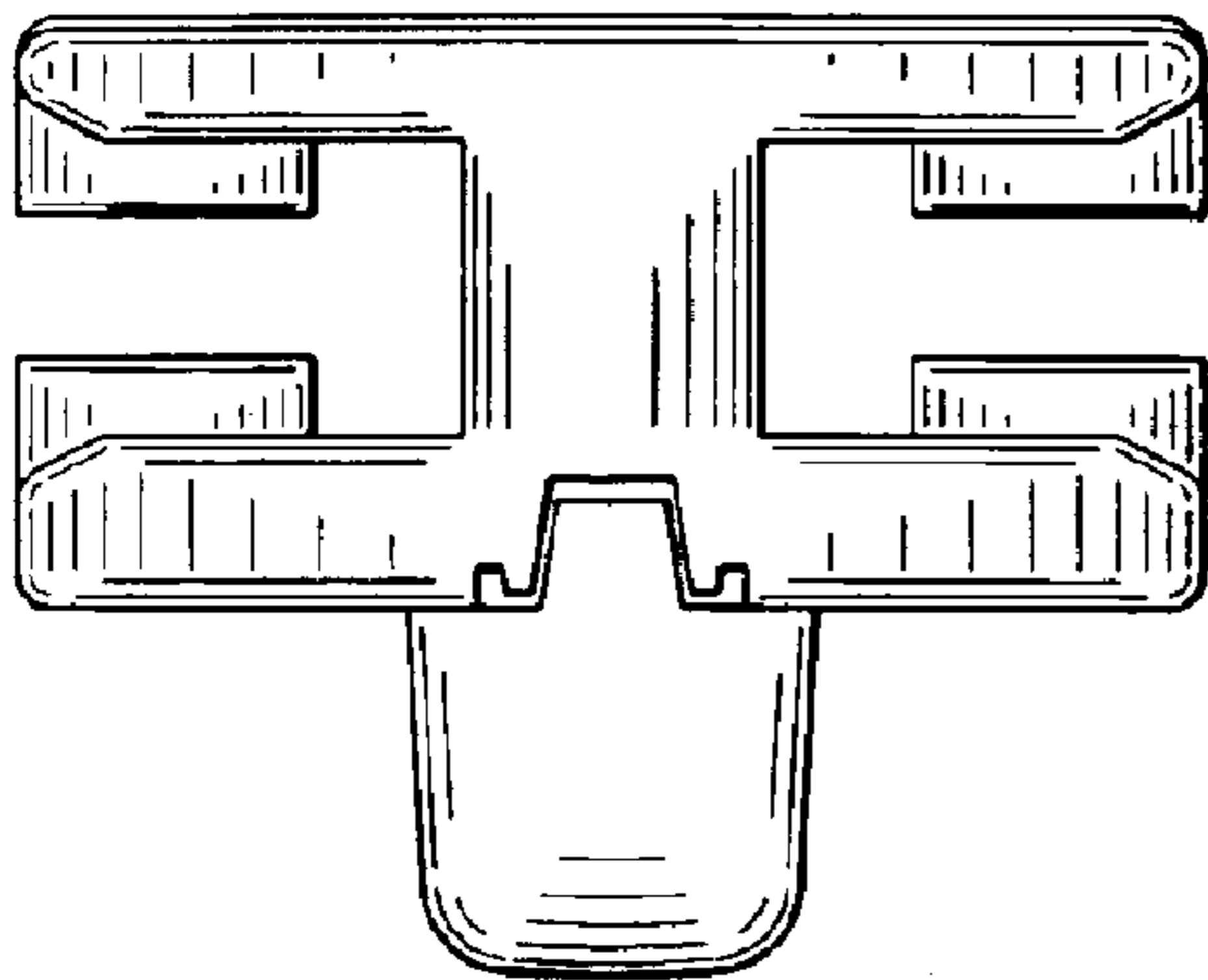

FIG.4

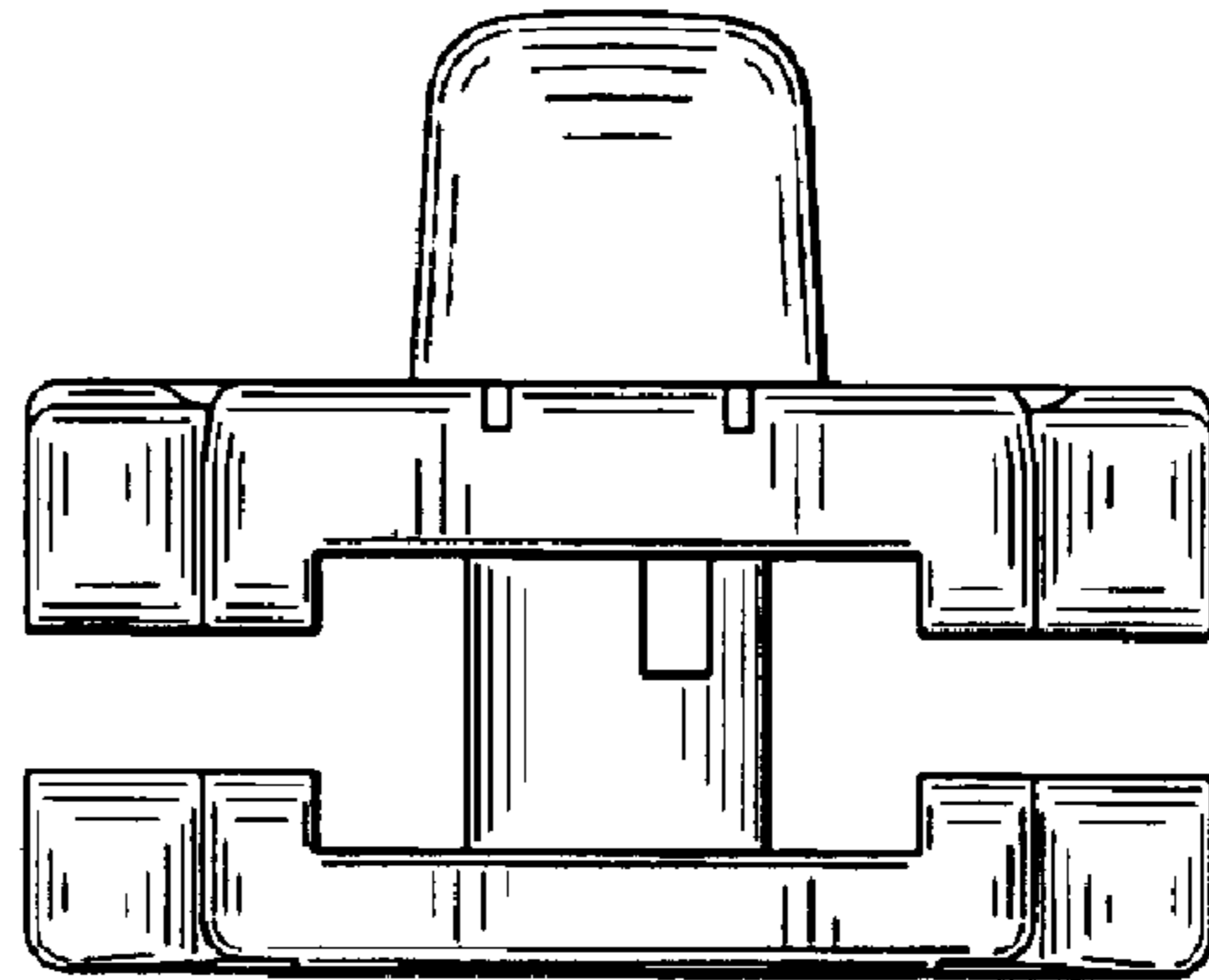

FIG.5

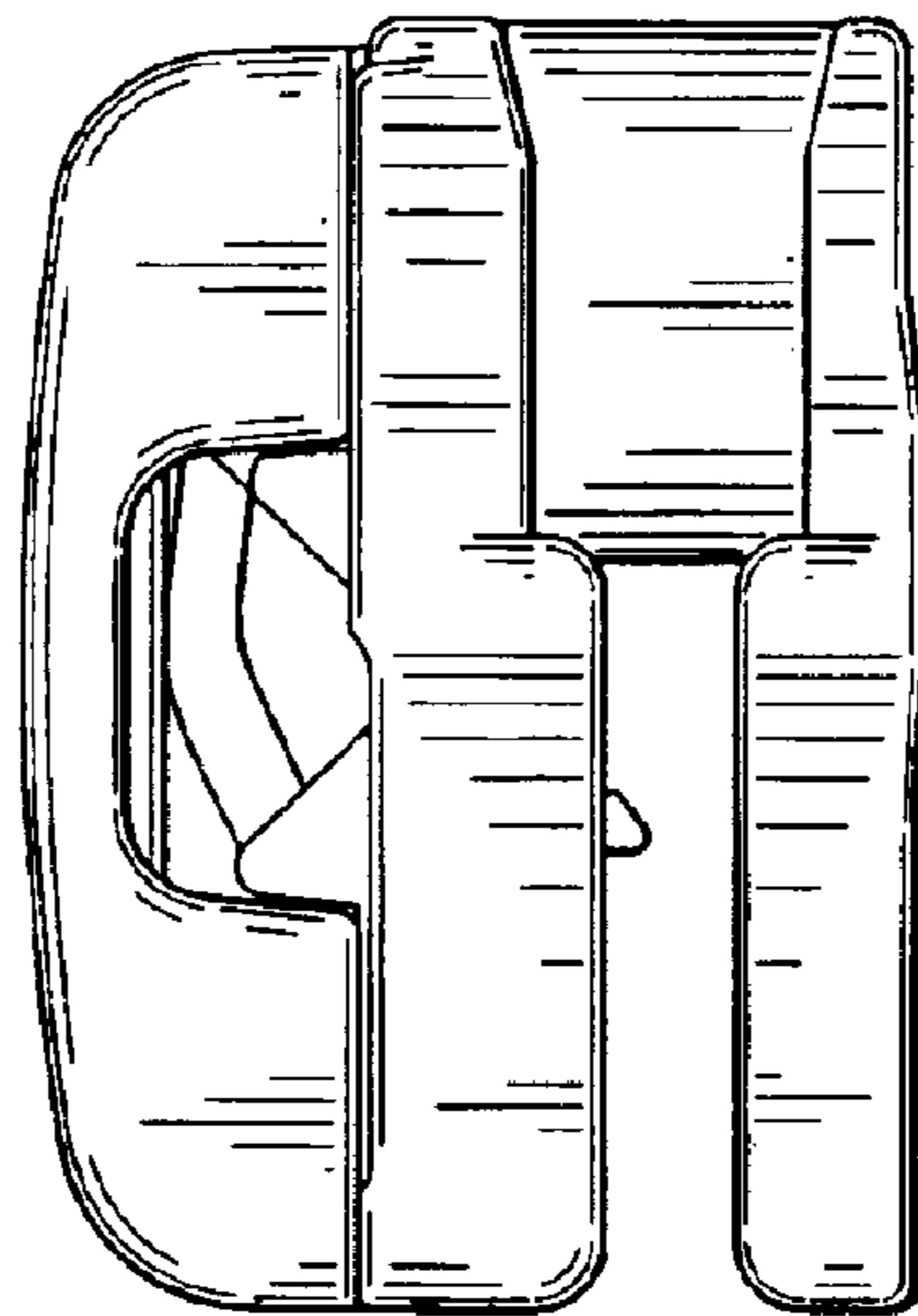

FIG. 6

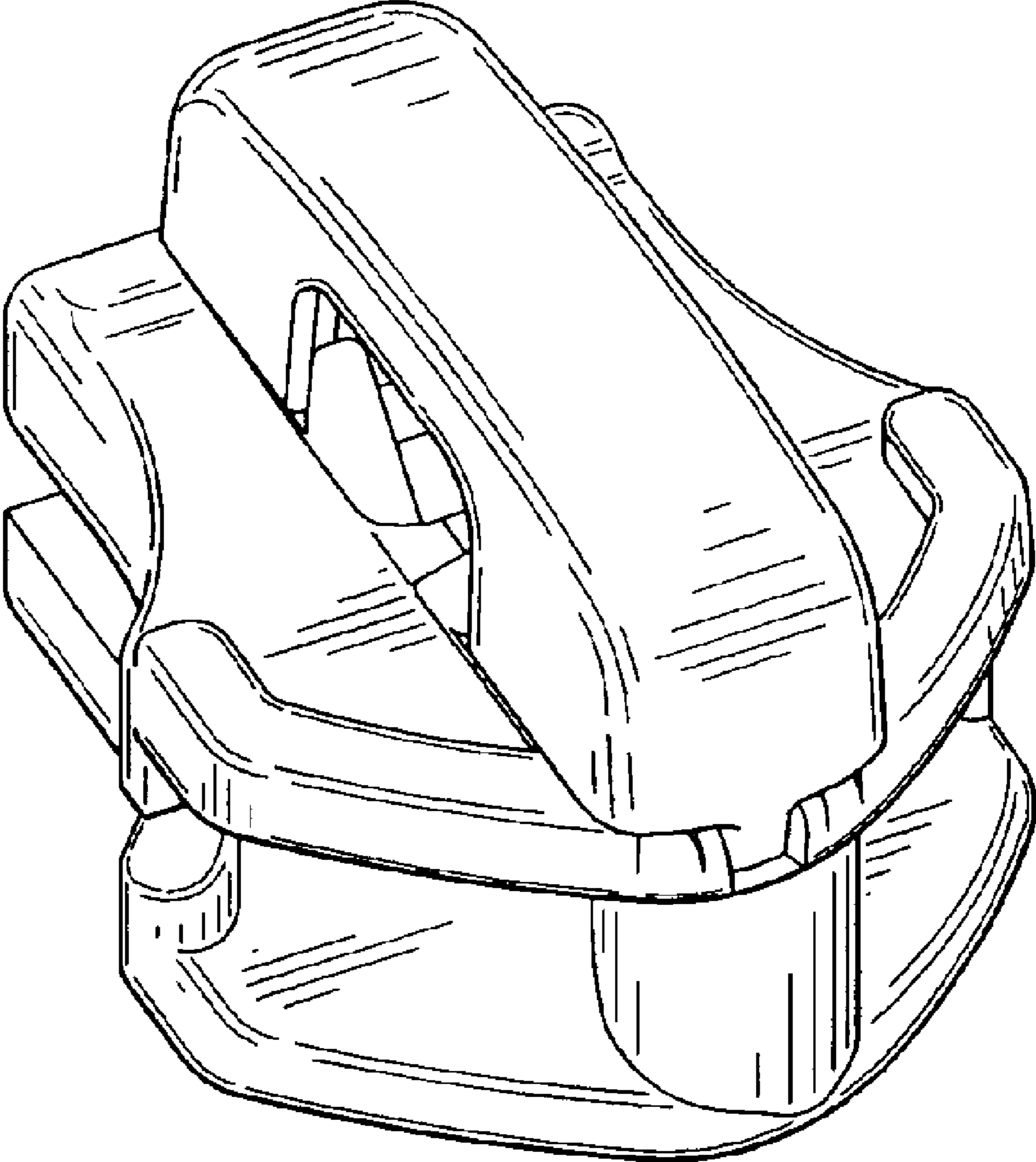

FIG. 7

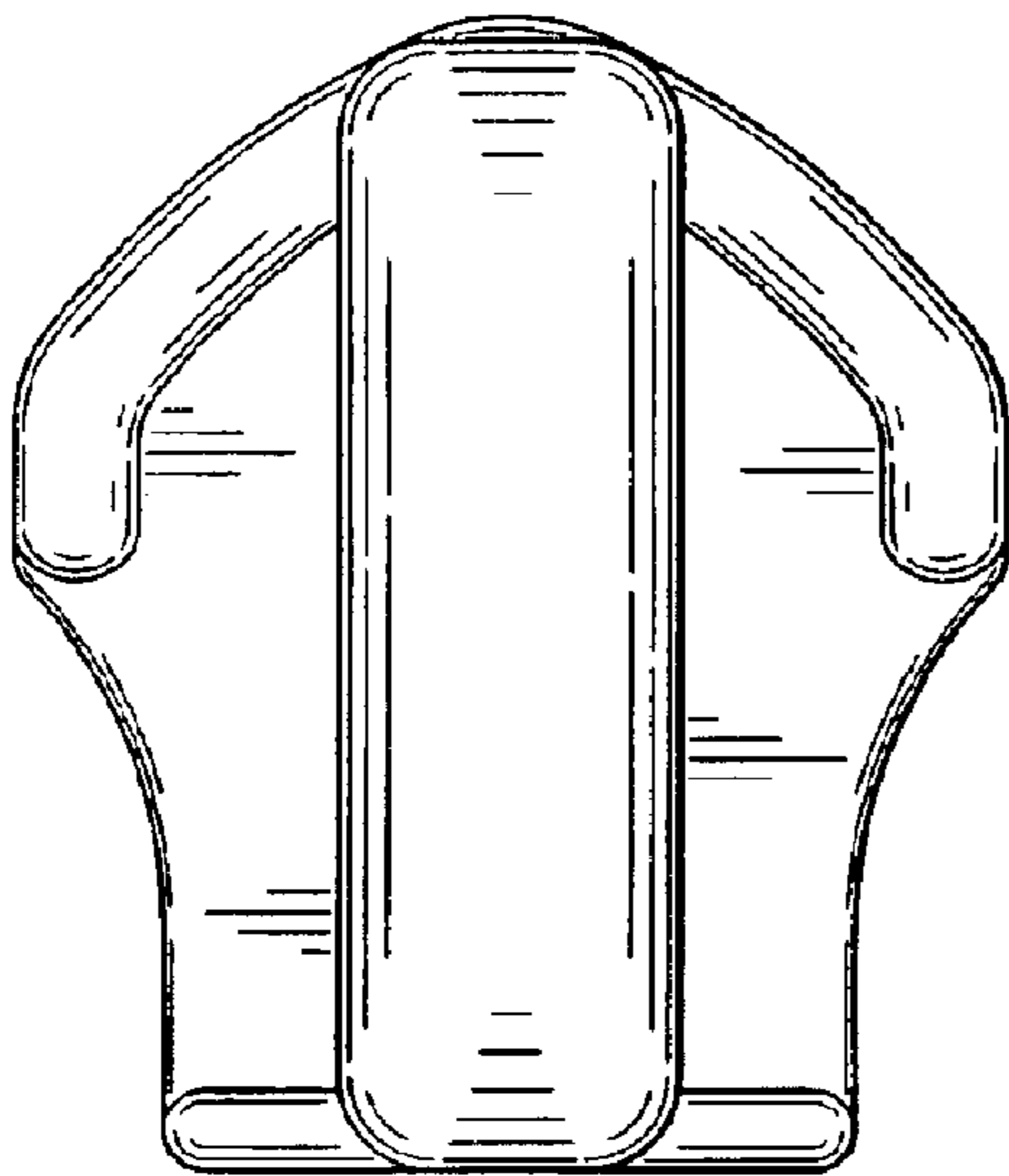

FIG. 8

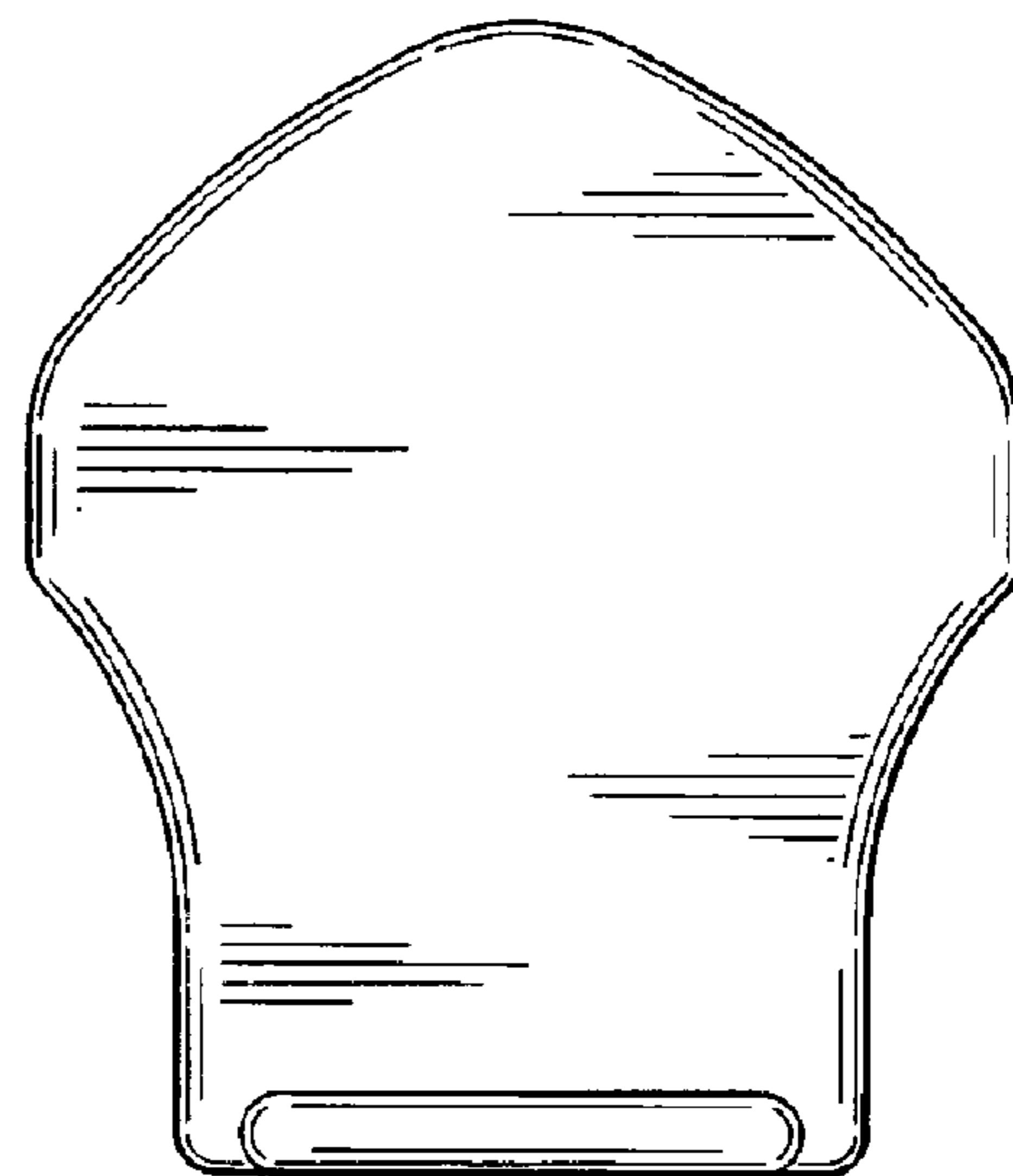

FIG.9

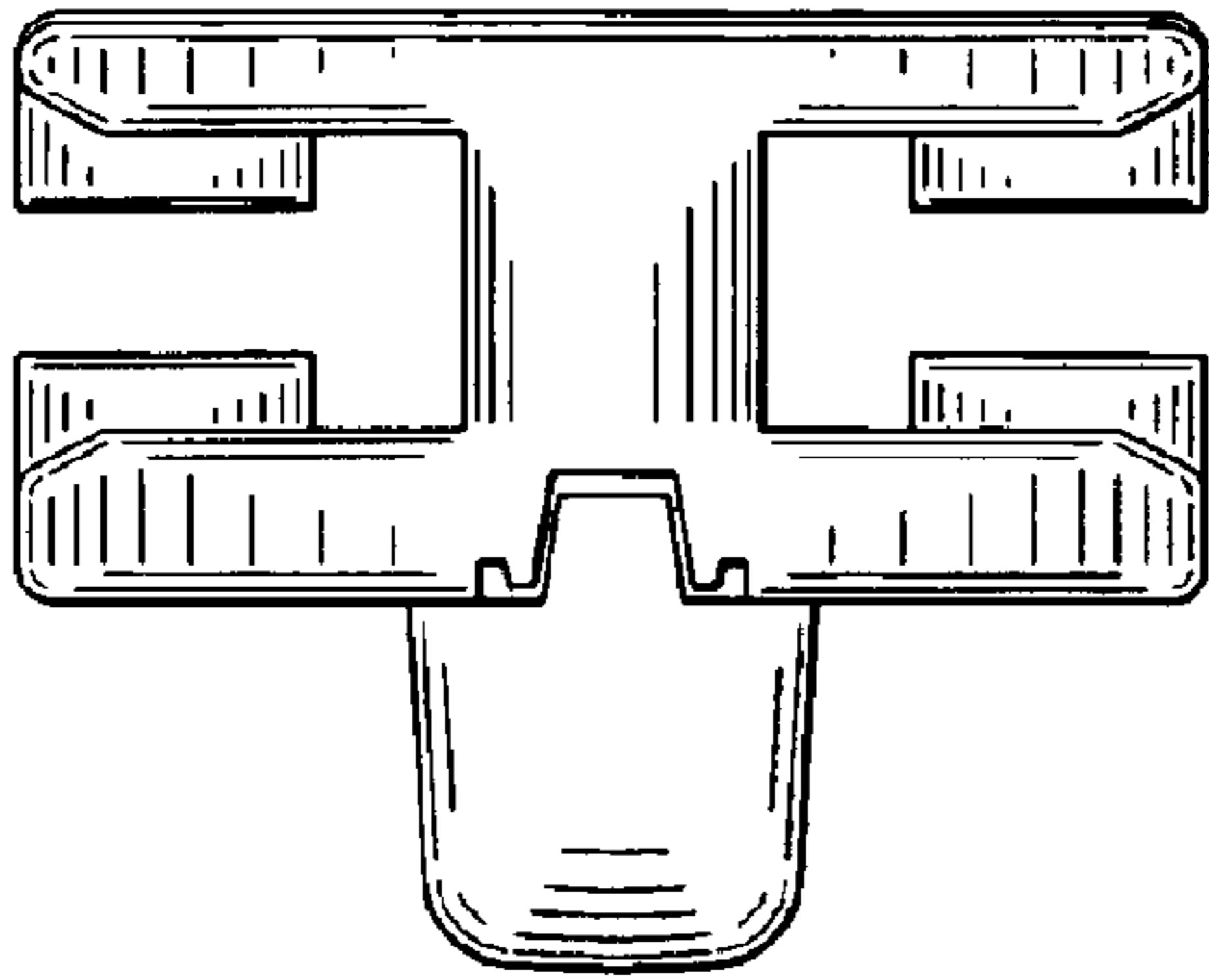

FIG.10

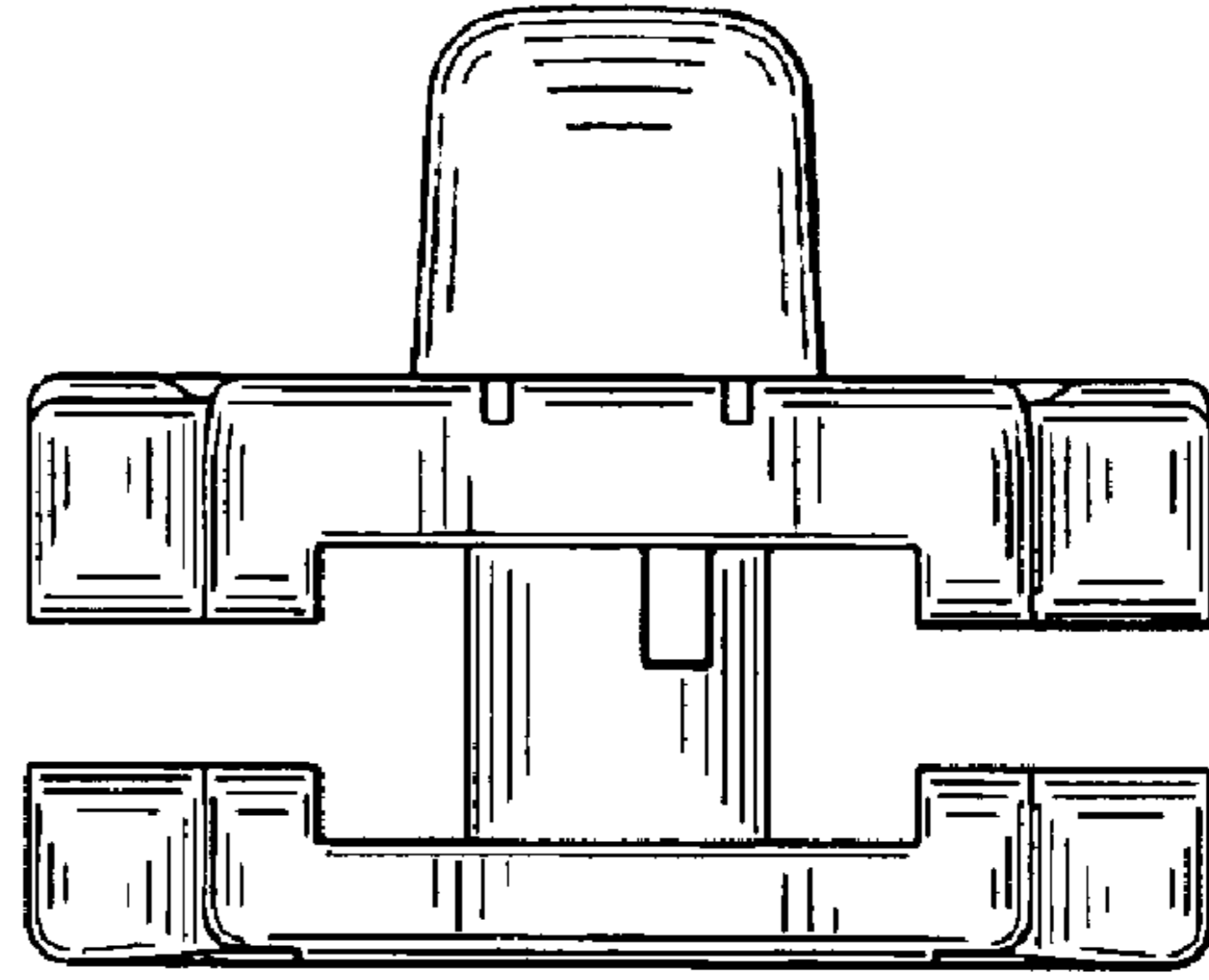

FIG.11

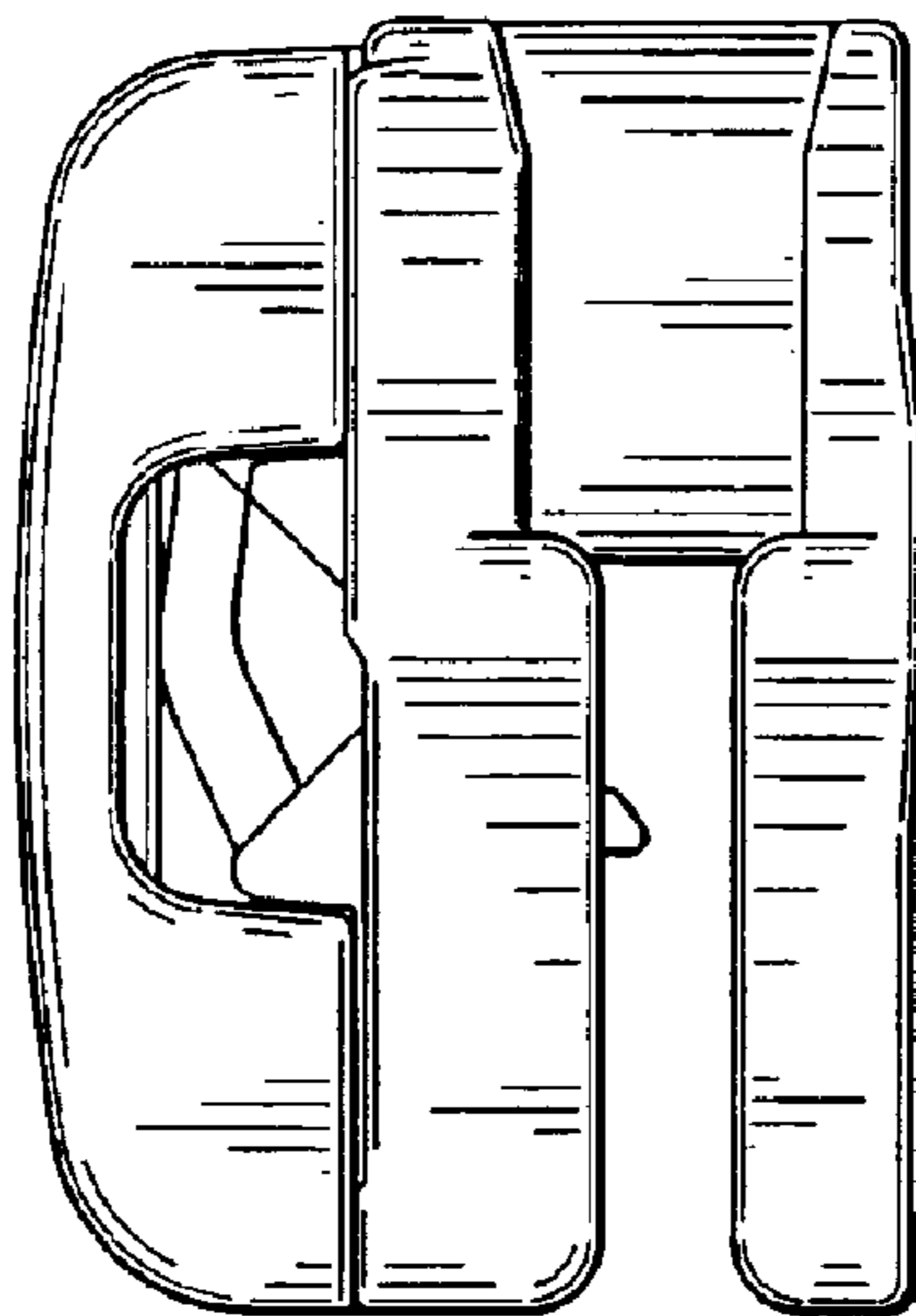

FIG.12

