

US00D509724S

(12) **United States Design Patent**  
**Cook**

(10) **Patent No.:** **US D509,724 S**  
(45) **Date of Patent:** **\*\* Sep. 20, 2005**

- (54) **COMBINATION UTILITY AND SPORTING KNIFE**
- (75) Inventor: **Vincent Cook**, Milford, CT (US)
- (73) Assignee: **The Stanley Works**, New Britain, CT (US)
- (\*\*) Term: **14 Years**
- (21) Appl. No.: **29/199,186**
- (22) Filed: **Feb. 12, 2004**
- (51) **LOC (8) Cl.** ..... **08-03**
- (52) **U.S. Cl.** ..... **D8/99**
- (58) **Field of Search** ..... D8/98, 99, 100, D8/105; 30/155, 156, 157, 158, 159, 160, 161, 162; 7/118

(56) **References Cited**

**U.S. PATENT DOCUMENTS**

D407,002 S	*	3/1999	Morton et al.	.....	D8/99
D407,004 S	*	3/1999	Hull et al.	.....	D8/99
D407,291 S	*	3/1999	Knoop	.....	D8/99
D432,386 S	*	10/2000	Elishewitz	.....	D8/99
D435,776 S	*	1/2001	Veltz et al.	.....	D8/99
D437,767 S	*	2/2001	Van Deursen	.....	D8/99
D472,446 S	*	4/2003	Brown	.....	D8/99
D473,778 S	*	4/2003	Hsu	.....	D8/99
D478,493 S	*	8/2003	Martone et al.	.....	D8/99

\* cited by examiner

*Primary Examiner*—Philip S. Hyder

(74) *Attorney, Agent, or Firm*—Pillsbury Winthrop LLP

(57) **CLAIM**

The ornamental design for a combination utility and sporting knife, as shown and described.

**DESCRIPTION**

FIG. 1 is a top right side perspective view of a combination utility and sporting knife according to an embodiment of our

design, the utility knife and sporting knife thereof in storage positions;

FIG. 2 is a perspective view of the combination utility and sporting knife shown in FIG. 1, from a bottom left side with respect to the view shown in FIG. 1, illustrating the utility knife moved to an operative position and the sporting knife in a storage position;

FIG. 3 is a right side view of the combination utility and sporting knife shown in FIG. 2;

FIG. 4 is a left side view of the combination utility and sporting knife shown in FIG. 2;

FIG. 5 is a top view of the combination utility and sporting knife shown in FIG. 2;

FIG. 6 is a bottom view of the combination utility and sporting knife shown in FIG. 2;

FIG. 7 is a front view of the combination utility and sporting knife shown in FIG. 2;

FIG. 8 is a rear view of the combination utility and sporting knife shown in FIG. 2;

FIG. 9 is a perspective view of the combination utility and sporting knife shown in FIG. 1, from a top left side with respect to the view shown in FIG. 1, illustrating the utility knife in a storage position and the sporting knife pivoted to an operative position;

FIG. 10 is a right side view of the combination utility and sporting knife shown in FIG. 9;

FIG. 11 is a left side view of the combination utility and sporting knife shown in FIG. 9;

FIG. 12 is a top view of the combination utility and sporting knife shown in FIG. 9;

FIG. 13 is a bottom view of the combination utility and sporting knife shown in FIG. 9;

FIG. 14 is a front view of the combination utility and sporting knife shown in FIG. 9; and,

FIG. 15 is a rear view of the combination utility and sporting knife shown in FIG. 9.

**1 Claim, 6 Drawing Sheets**

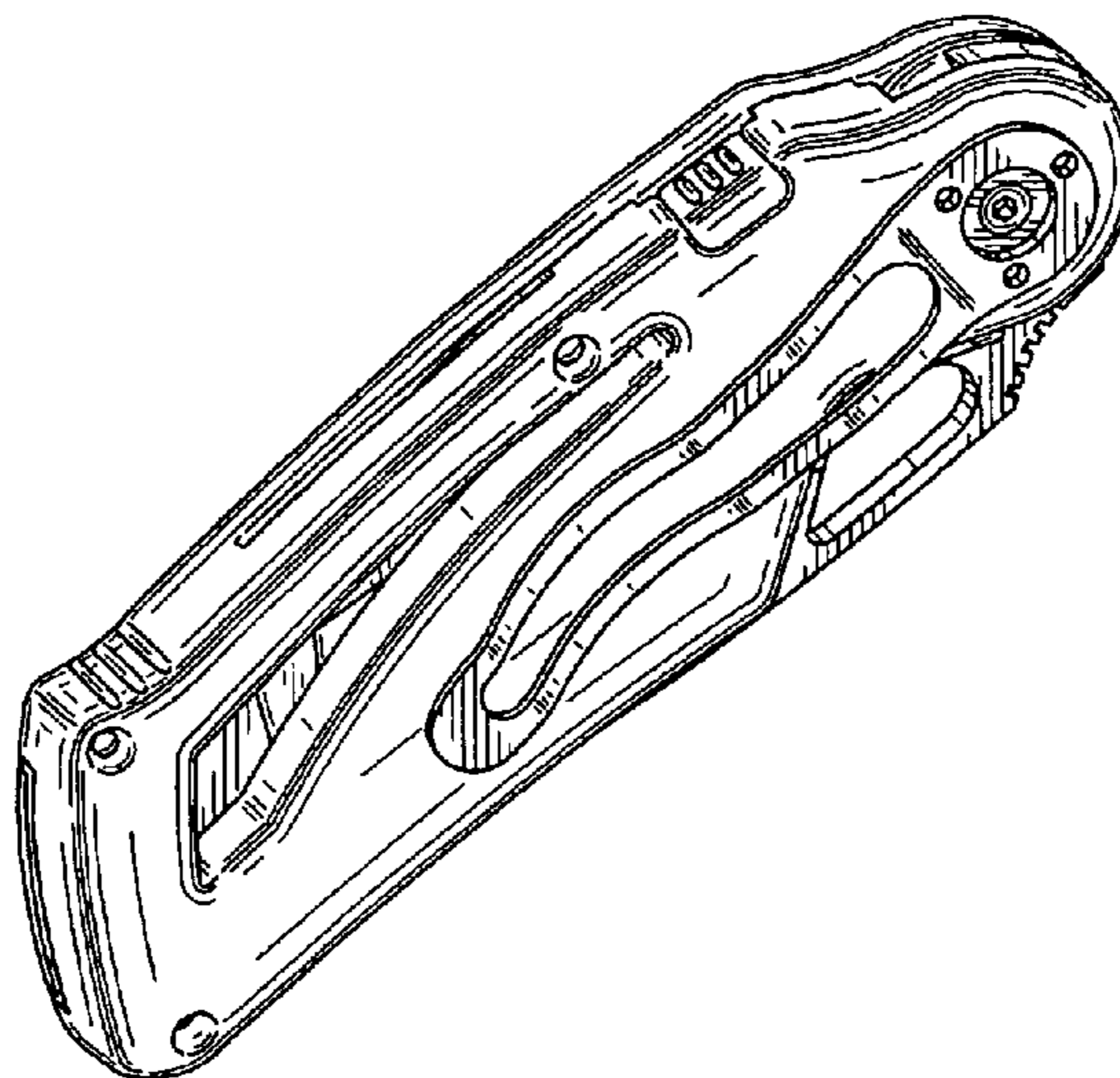

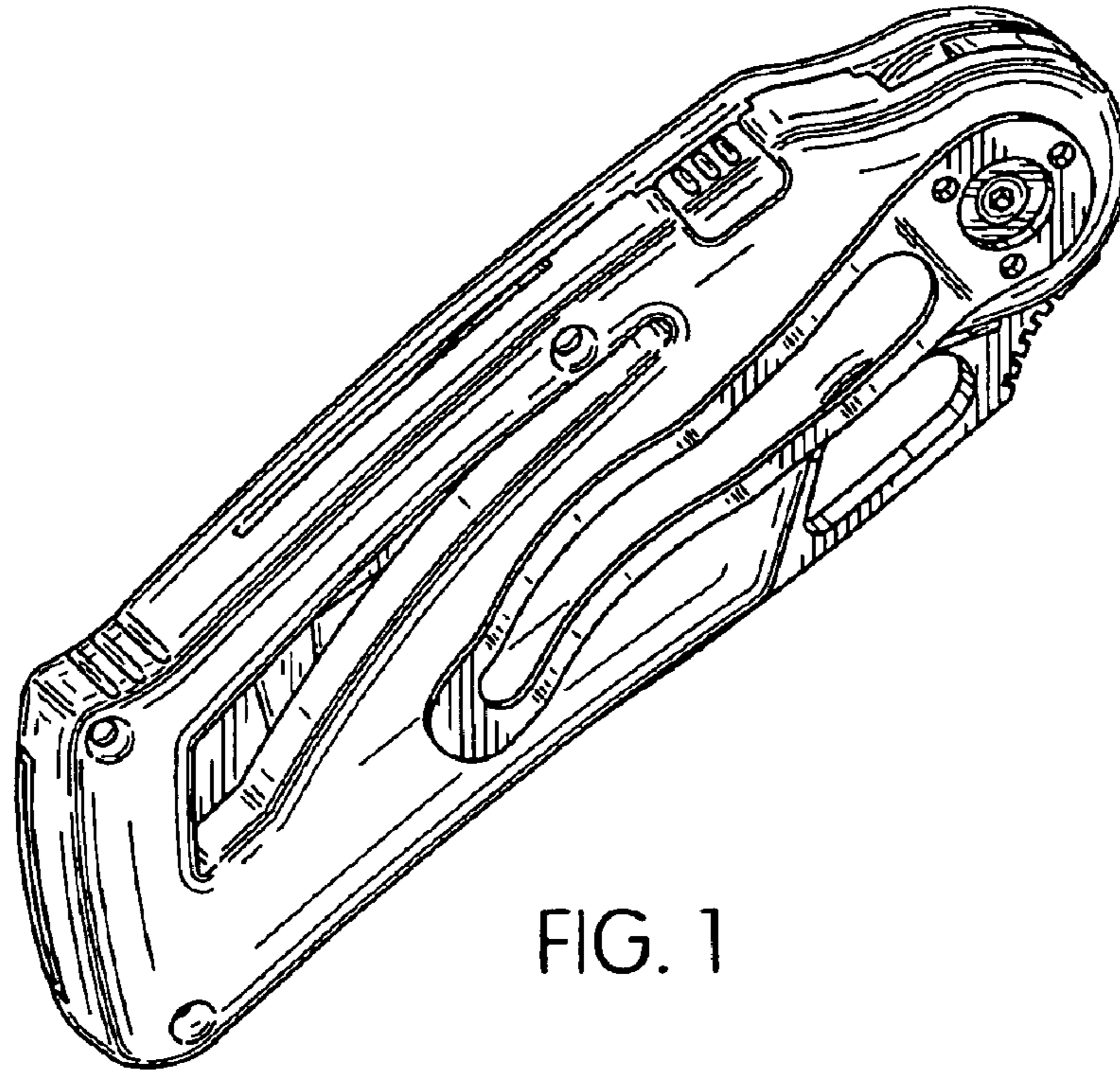

FIG. 1

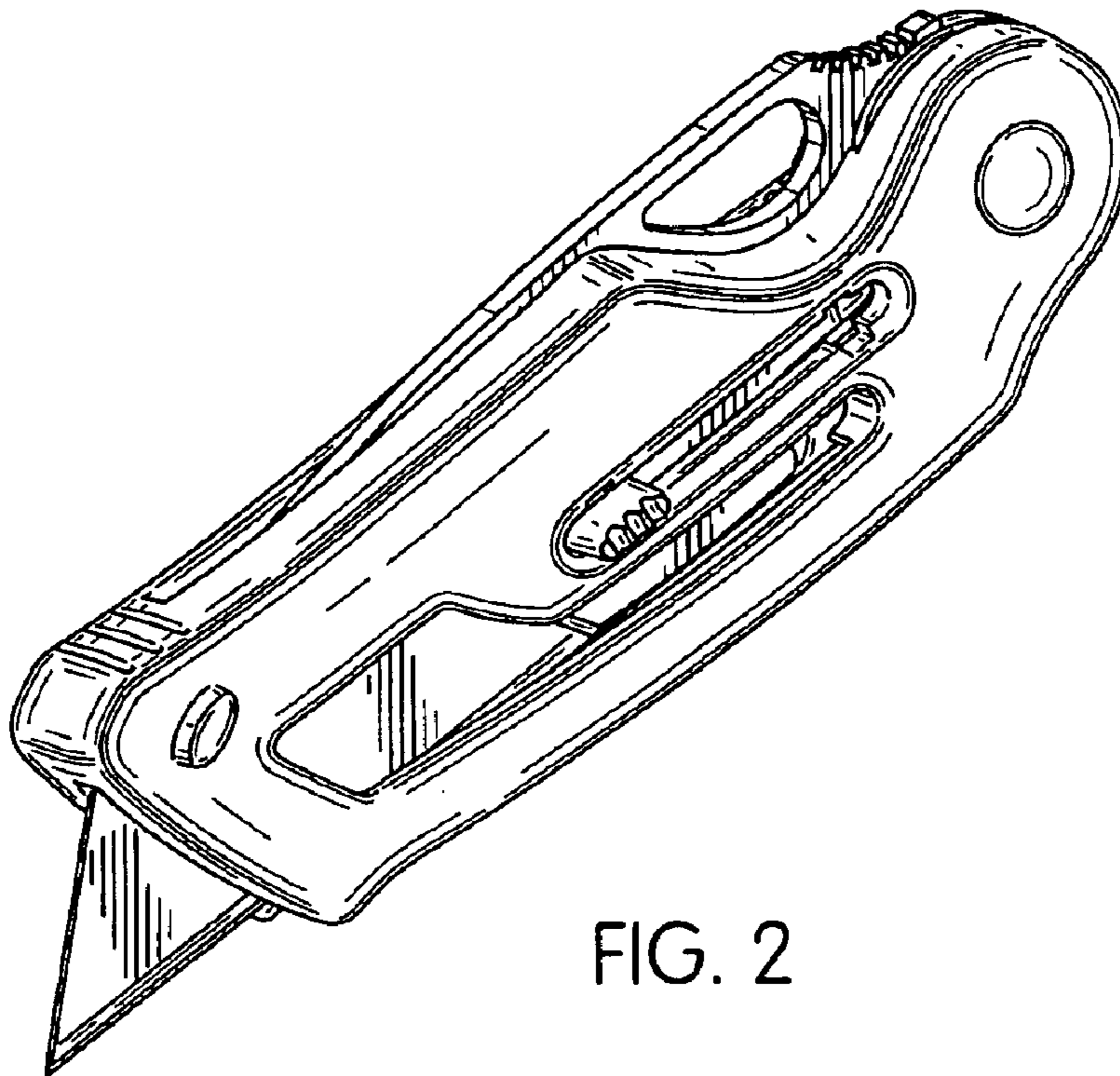

FIG. 2

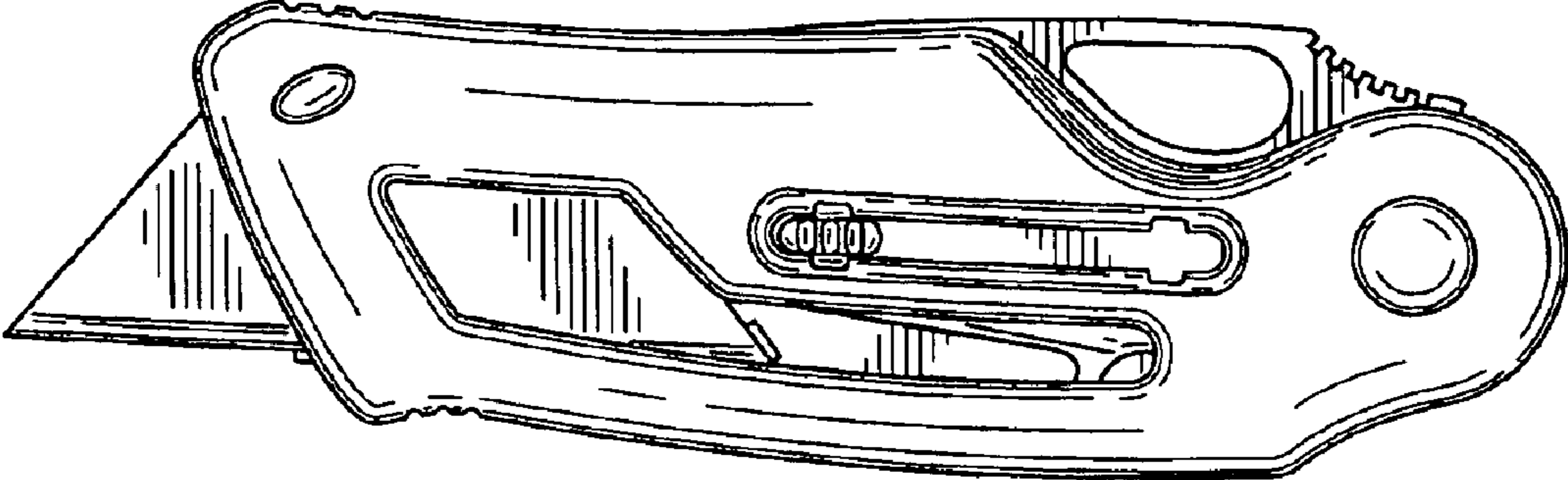

FIG. 3

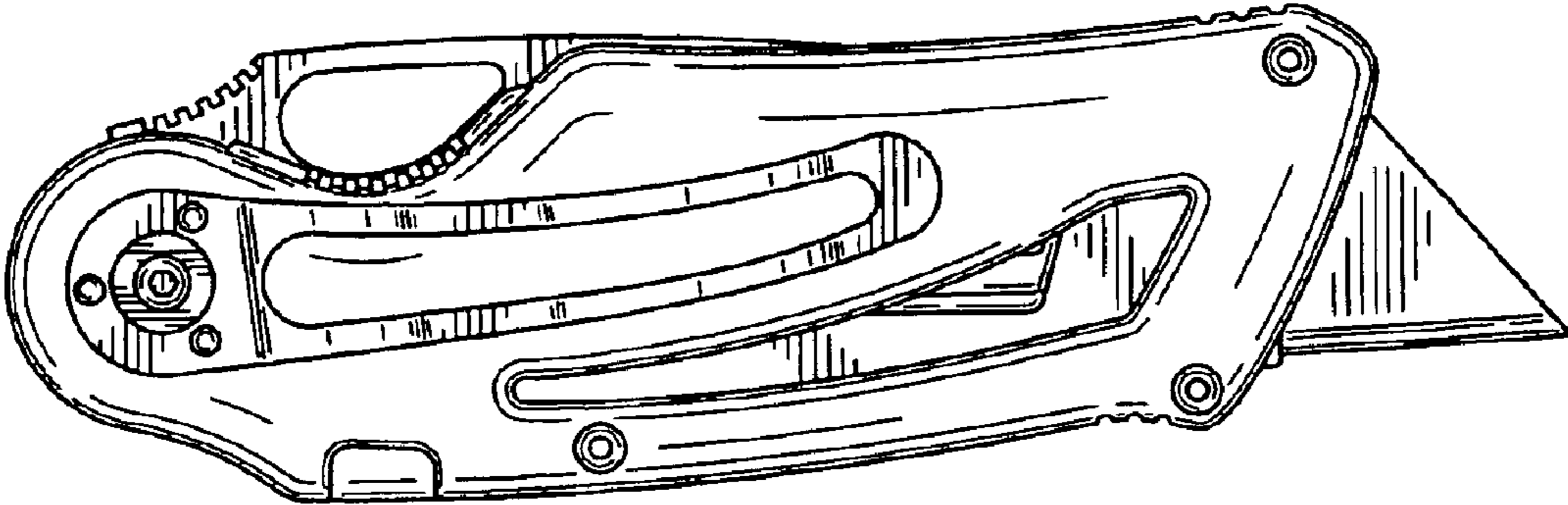

FIG. 4



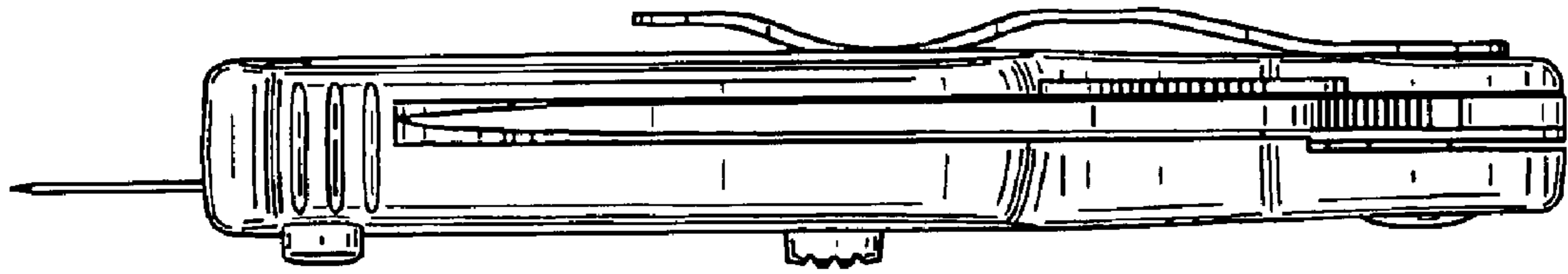

FIG. 5

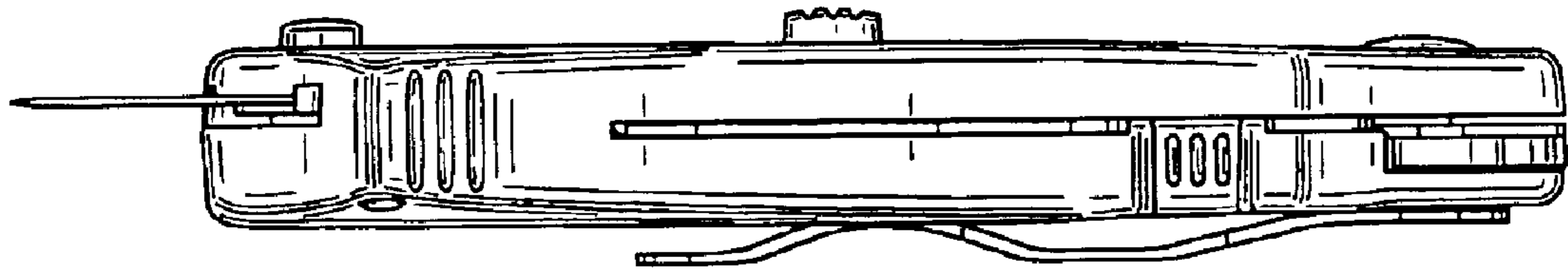

FIG. 6

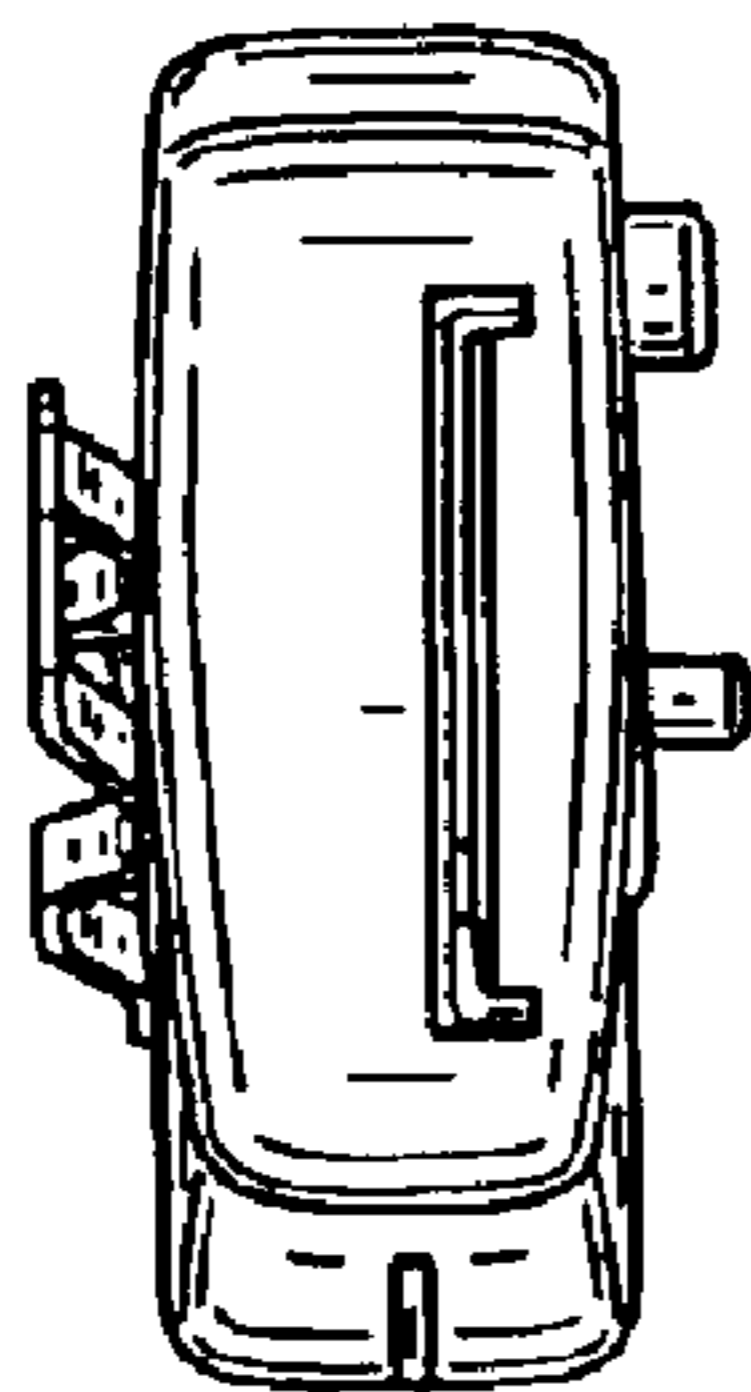

FIG. 7

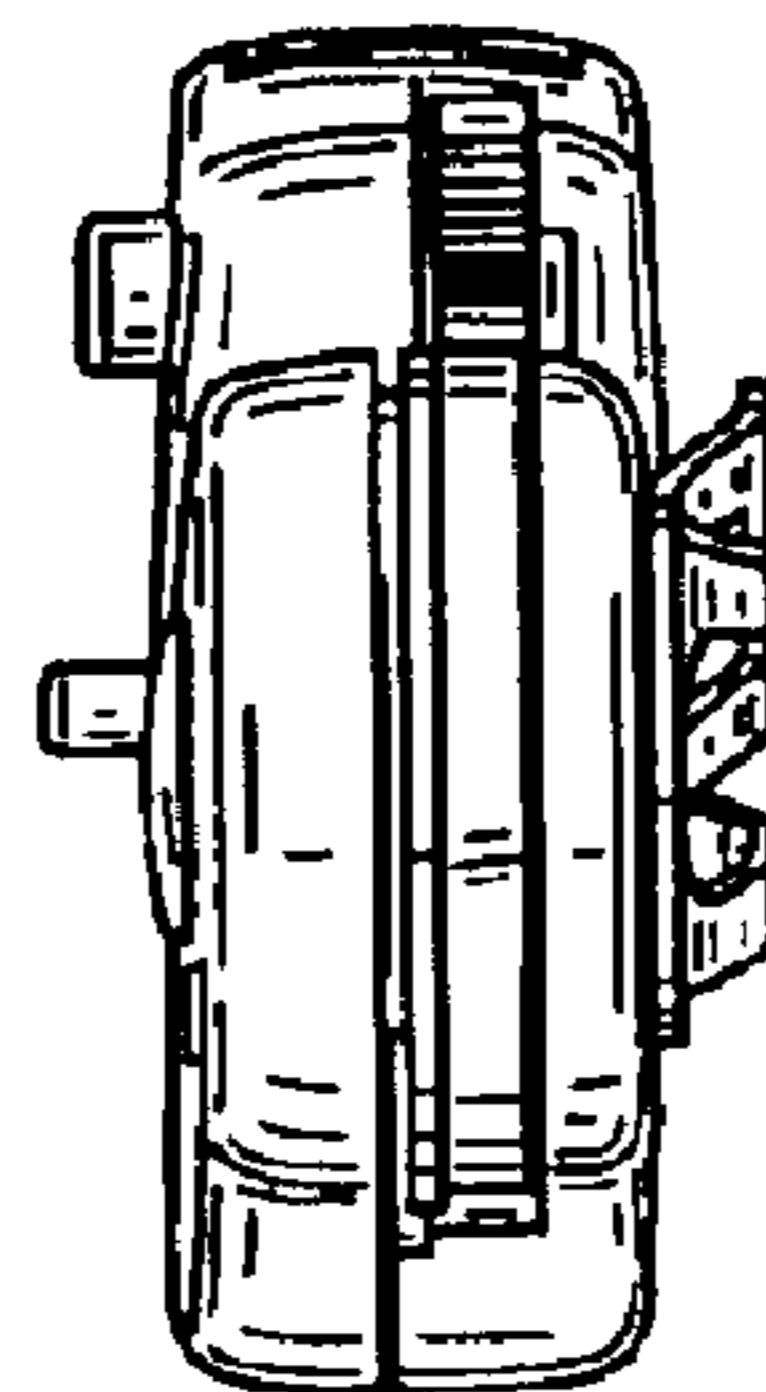

FIG. 8

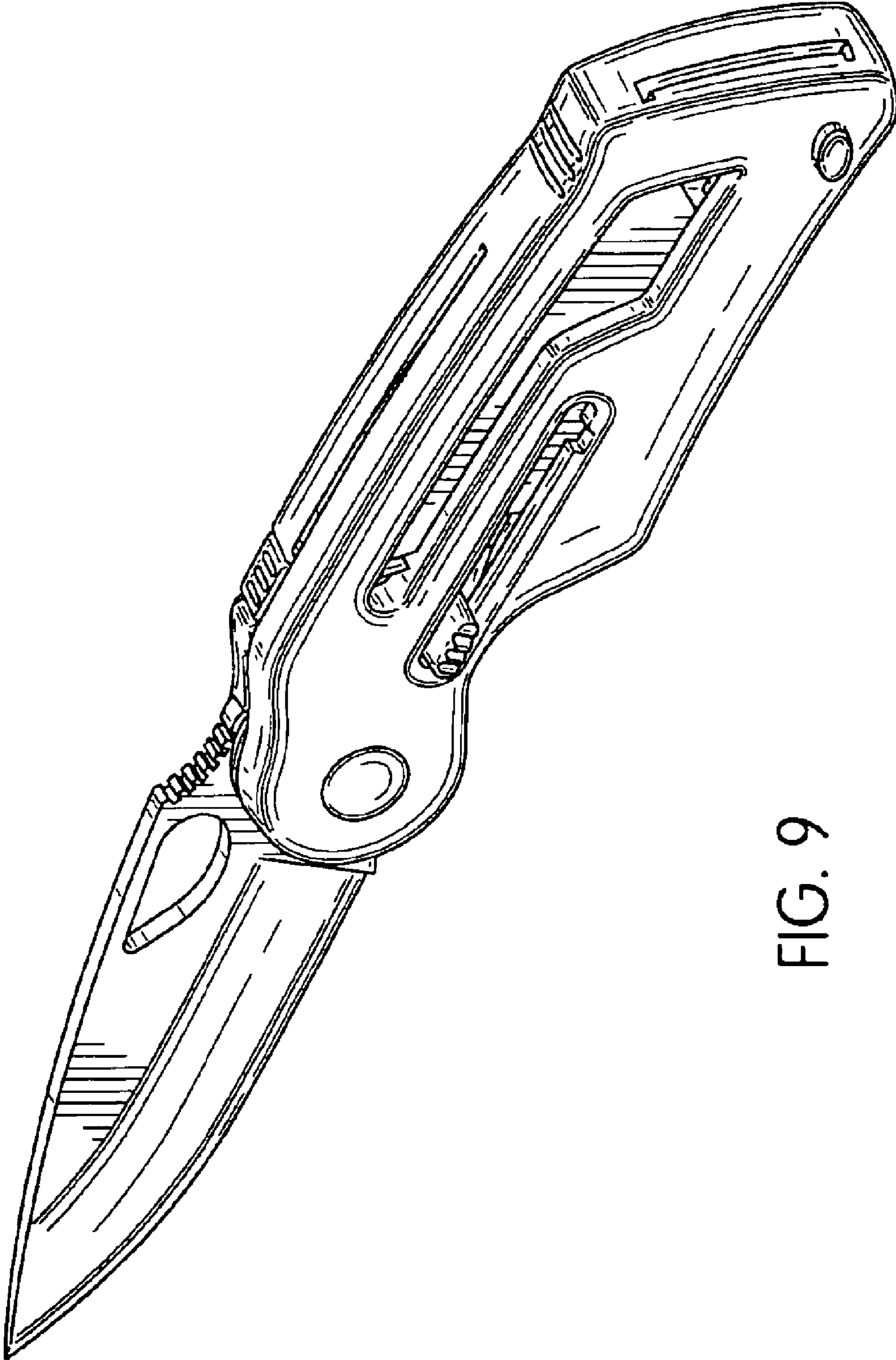

FIG. 9

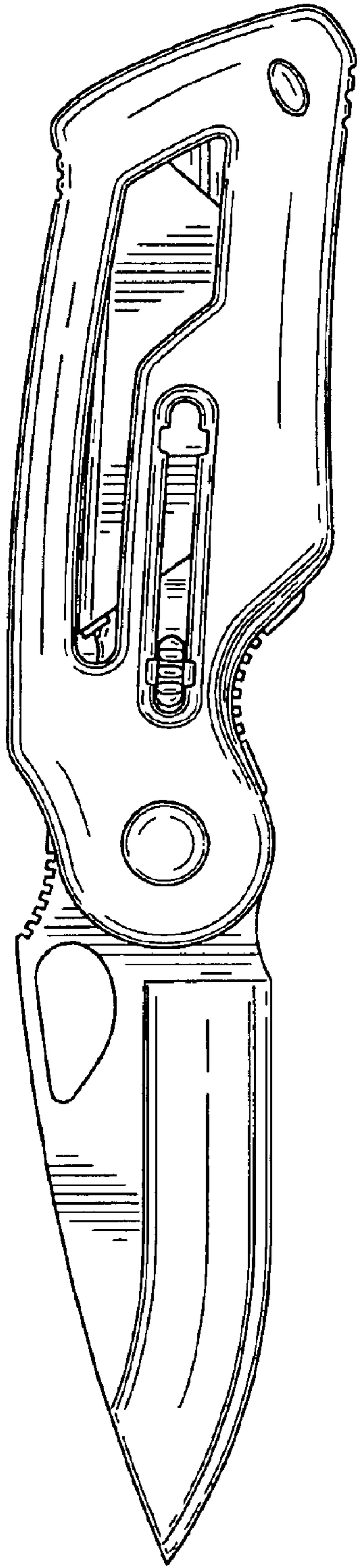

FIG. 10

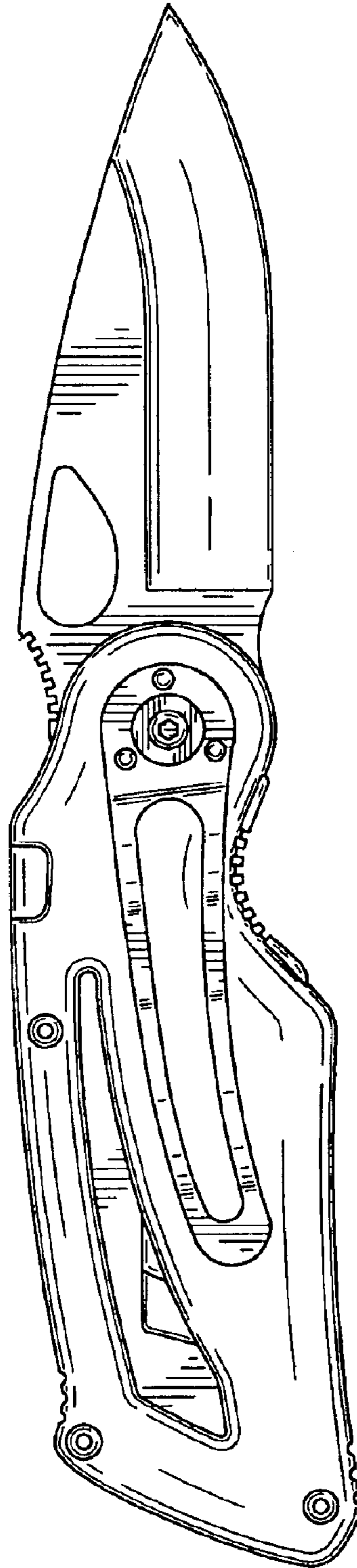

FIG. 11

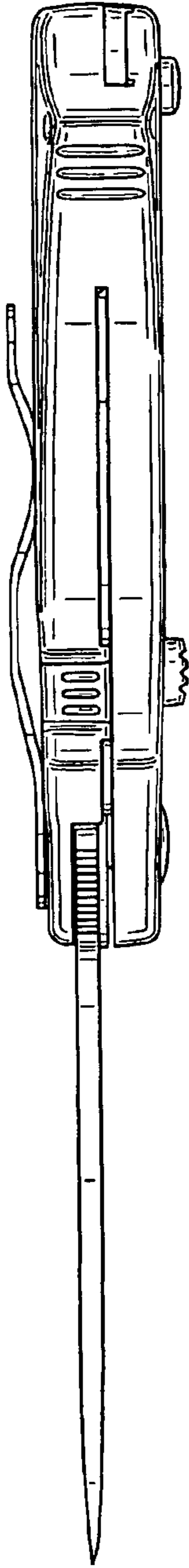

FIG. 12

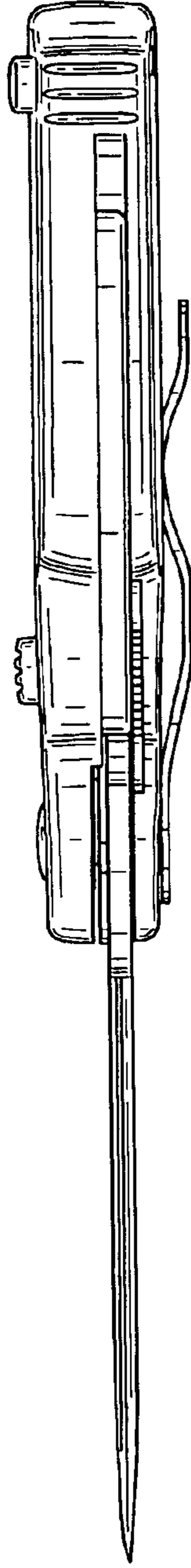

FIG. 13

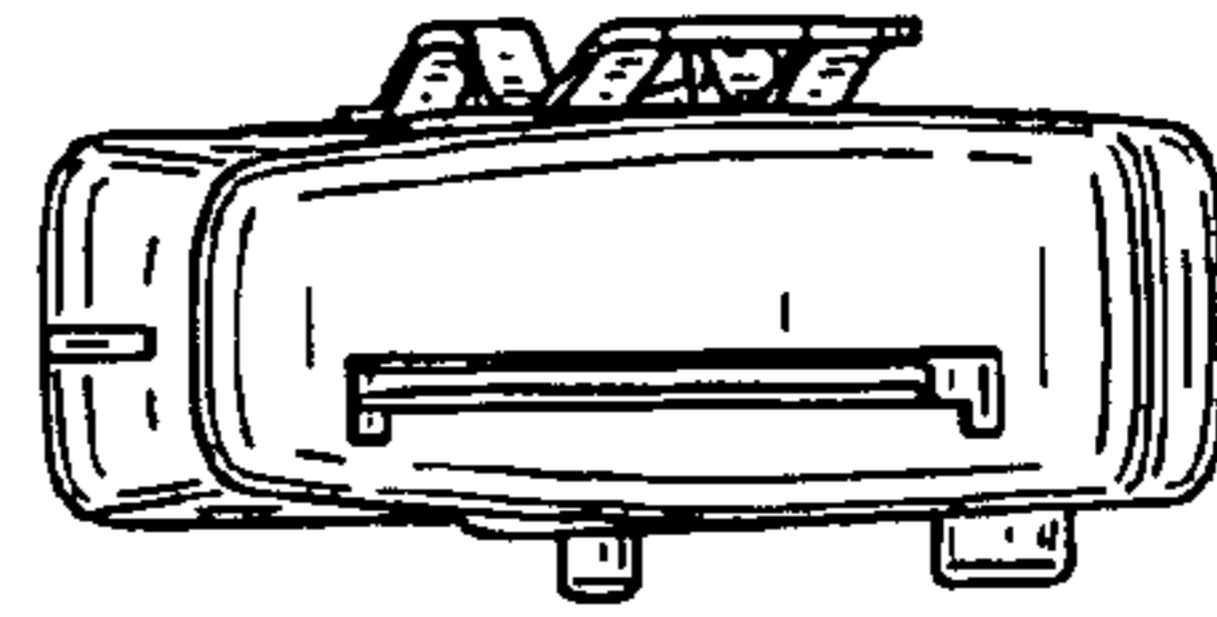

FIG. 15

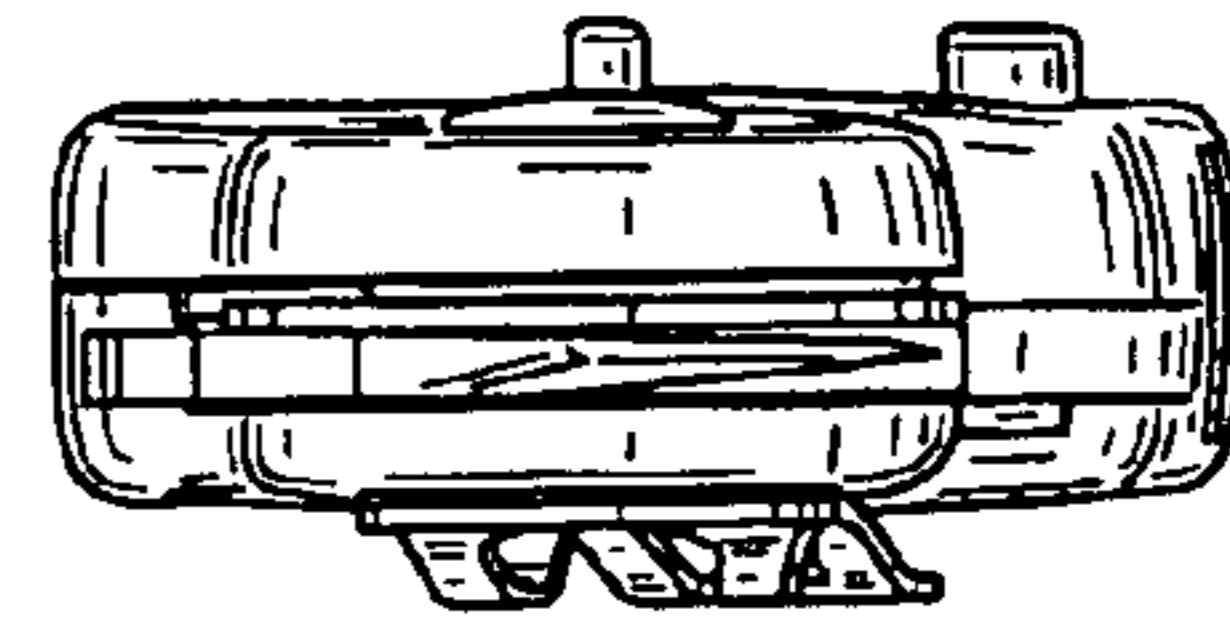

FIG. 14