



US00D509718S

(12) **United States Design Patent** (10) **Patent No.:** **US D509,718 S**
Jimenez (45) **Date of Patent:** **** Sep. 20, 2005**

(54) **HANDLE**

(75) Inventor: **Eduardo J. Jimenez**, Manalapan, NJ (US)

(73) Assignee: **KC Holdings, LLC**

(**) Term: **14 Years**

(21) Appl. No.: **29/211,620**

(22) Filed: **Aug. 19, 2004**

Related U.S. Application Data

(63) Continuation-in-part of application No. 29/195,532, filed on Dec. 15, 2003.

(51) **LOC (8) Cl.** **08-05**

(52) **U.S. Cl.** **D8/45; D8/10**

(58) **Field of Search** **D8/10, 83, 45, D8/107; 81/436; 15/235.4, 235.5**

(56) **References Cited**

U.S. PATENT DOCUMENTS

3,173,462 A * 3/1965 Koepfel 81/436

(Continued)

Primary Examiner—Holly Baynham

(74) *Attorney, Agent, or Firm*—Kevin Alan Wolff; Wolff Law Offices, PLLC

(57) **CLAIM**

The ornamental design for a handle, as shown and described.

DESCRIPTION

FIG. 1 is a perspective view of a first embodiment of the handle showing my new design looking downwardly at a front and left side thereof, and showing a tool blade and unclaimed portion of the handle to the left in broken lines attached to the handle;

FIG. 2 is a left elevation view of a first embodiment of the handle and the attached blade and unclaimed portion of the handle in broken lines to the left of the handle;

FIG. 3 is a top plan view of a first embodiment of the handle and the attached blade and unclaimed portion of the handle in broken lines to the left of the handle;

FIG. 4 is a bottom plan view of a first embodiment of the handle and the attached blade and unclaimed portion of the handle in broken lines to the left of the handle;

FIG. 5 is a front elevation view of a first embodiment of the handle and a portion of the attached blade and unclaimed portion of the handle in broken lines; and

FIG. 6 is a rear elevation view of a first embodiment of the handle with the saw blade and unclaimed portion of the handle in broken lines;

FIG. 7 is a perspective view of a second embodiment of the handle showing my new design looking downwardly at a front and left side thereof, and showing a tool blade and unclaimed portion of the handle to the left in broken lines attached to the handle;

FIG. 8 is a left elevation view of a second embodiment of the handle and the attached blade and unclaimed portion of the handle in broken lines to the left of the handle;

FIG. 9 is a top plan view of a second embodiment of the handle and the attached blade and unclaimed portion of the handle in broken lines to the left of the handle;

FIG. 10 is a bottom plan view of a second embodiment of the handle and the attached blade and unclaimed portion of the handle in broken lines to the left of the handle;

FIG. 11 is a front elevation view of a second embodiment of the handle and a portion of the attached blade and unclaimed portion of the handle in broken lines; and

FIG. 12 is a rear elevation view of a second embodiment of the handle with the saw blade and unclaimed portion of the handle in broken lines.

The broken lines showing the tool blade, the unclaimed portion of the handle, the broken line oval on the side(s) of the handle, and the broken lines around the front and rear circumference of the handle are for illustrative purposes only and forms no part of the claimed design. The demarcation line near the center of the side view of the handle delineates the claimed portion of the handle to the right from the unclaimed portion of the handle to the left. A right side elevation view of the saw handle is a mirror image of the left side elevation view.

1 Claim, 10 Drawing Sheets

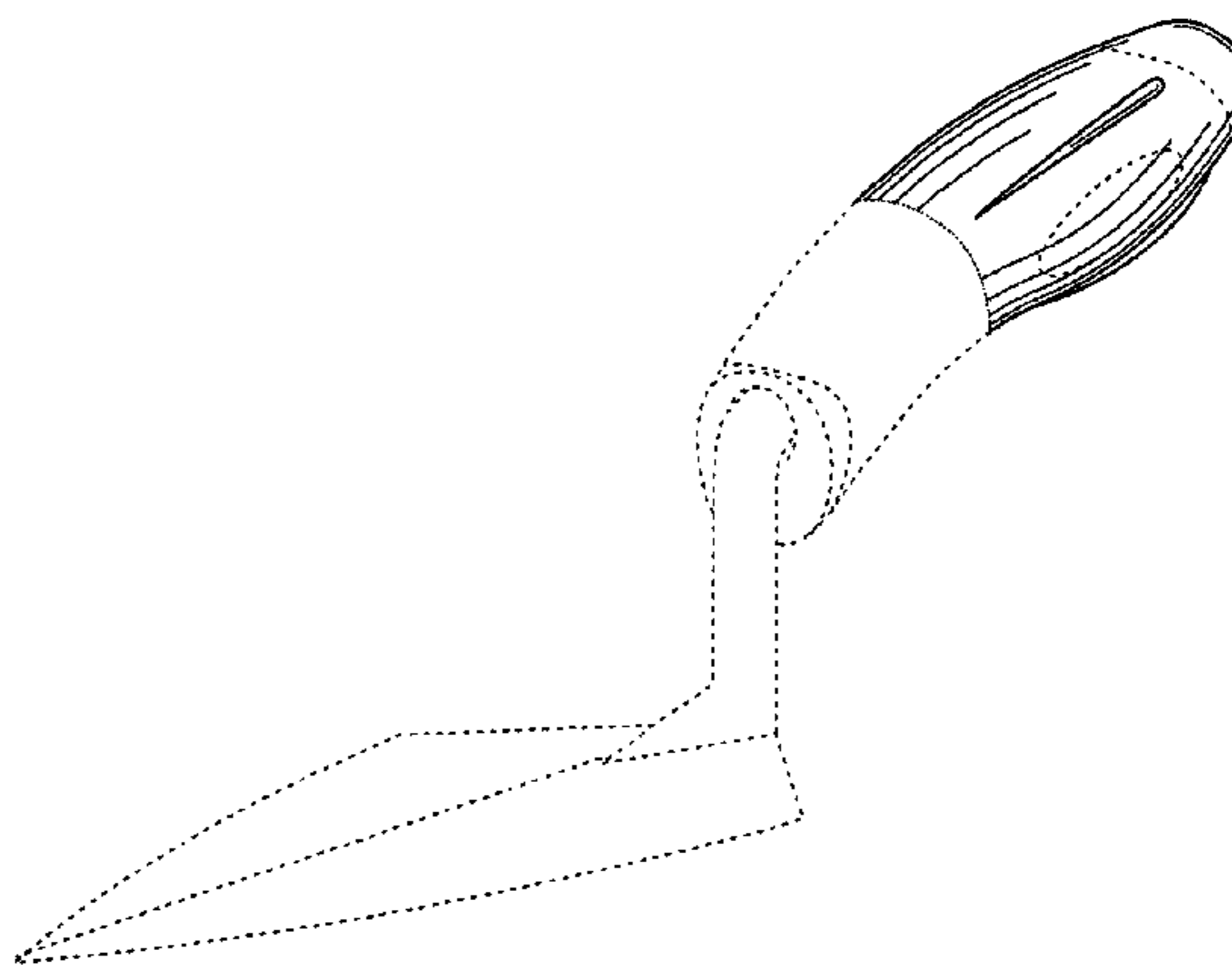
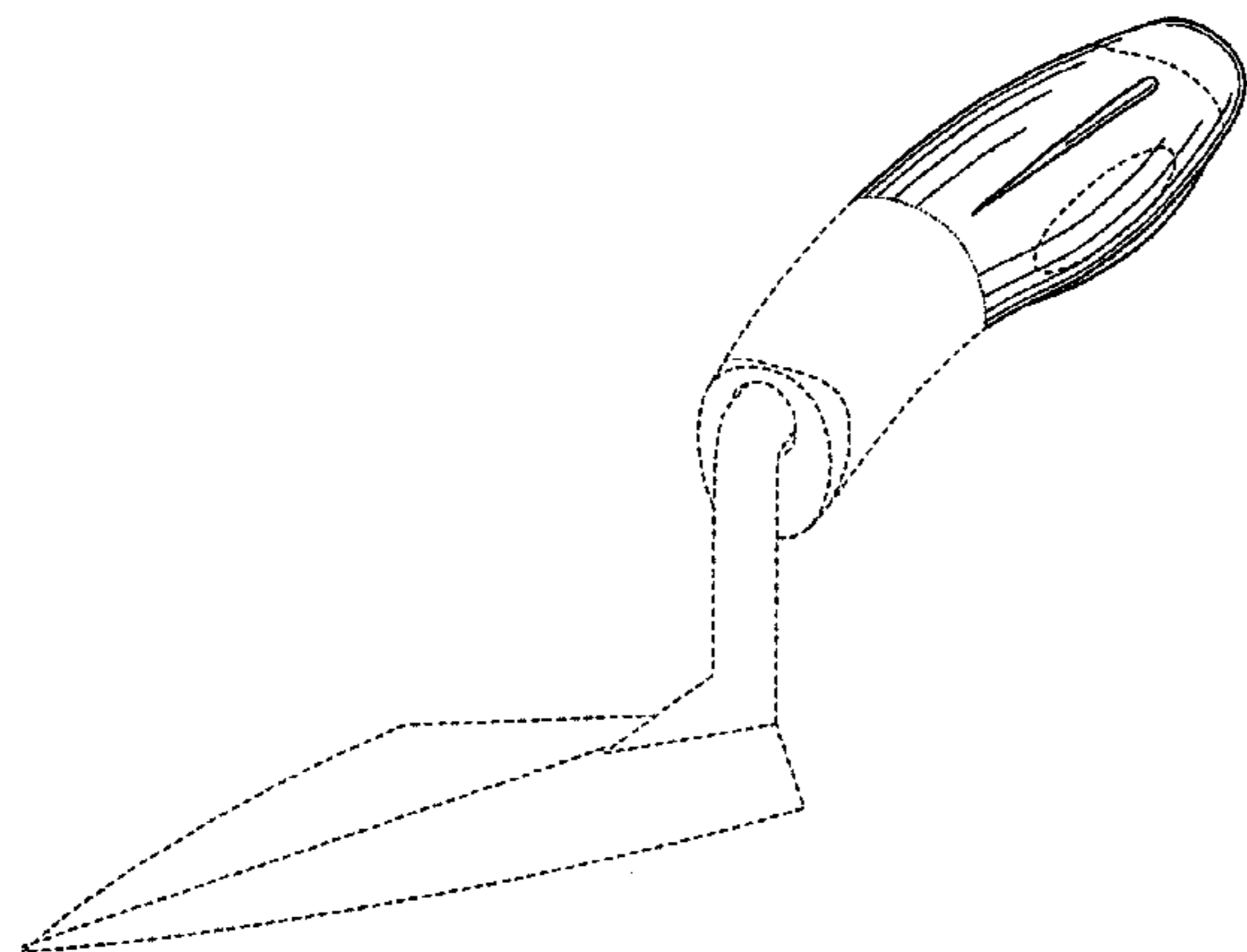

US D509,718 S

Page 2

U.S. PATENT DOCUMENTS

5,446,941 A	*	9/1995	Kelsay	15/235.4	D445,658 S	7/2001	Dierolf	D8/83	
D371,499 S		7/1996	Gomas	D8/107	D446,105 S	8/2001	Hsiao	D8/107	
D398,828 S		9/1998	Shiao	D8/83	D455,944 S	4/2002	Chen	D8/107	
D408,252 S		4/1999	Holland-Letz	D8/83	D456,686 S	5/2002	Holland-Letz	D8/83	
D418,035 S	*	12/1999	Hatch	D8/83	D483,638 S	12/2003	Jimenez	D8/83	
D436,822 S		1/2001	Douglas	D8/83	D486,717 S	*	2/2004	Chen	D8/107
D442,053 S		5/2001	Jimenez	D8/95						

* cited by examiner

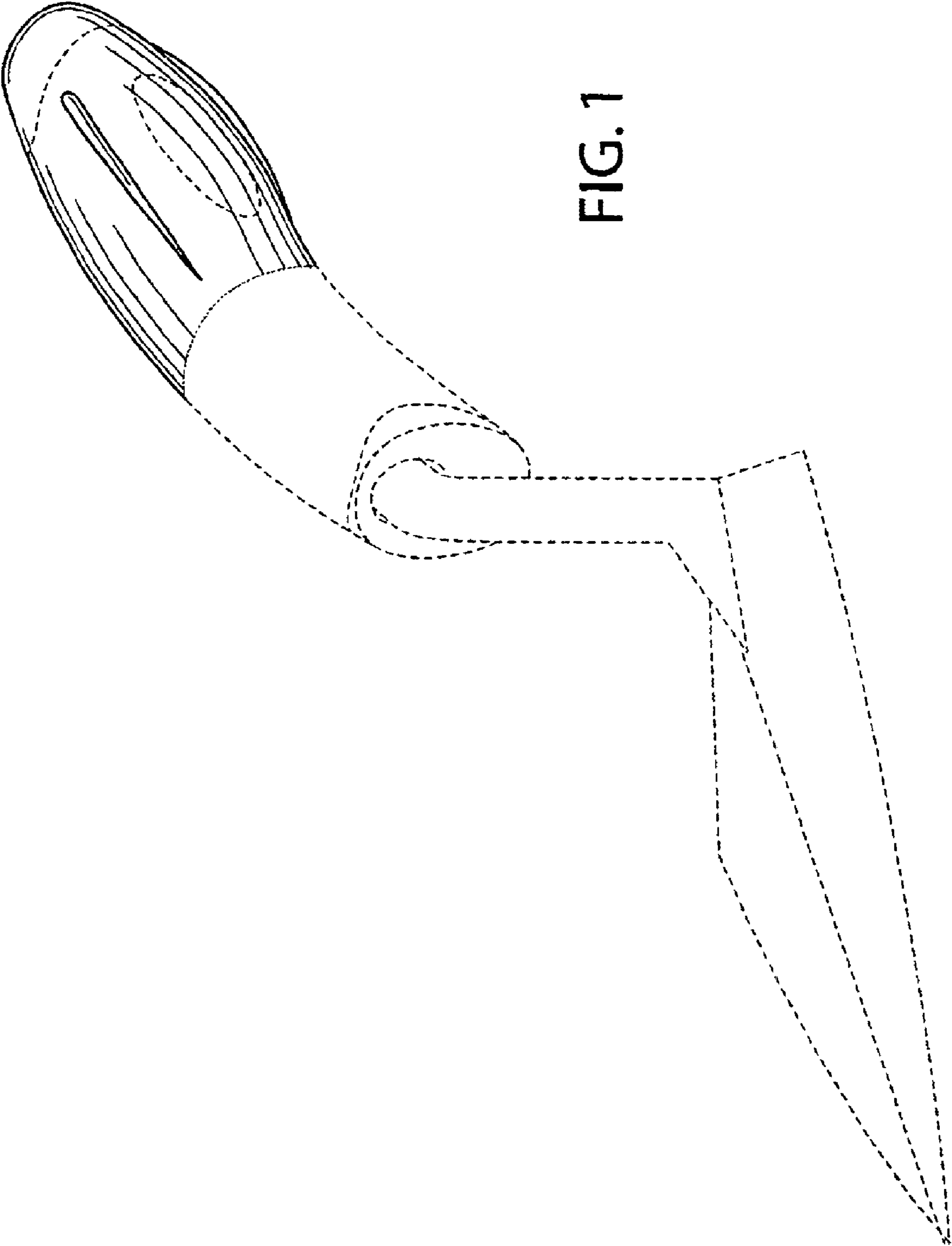

FIG. 1

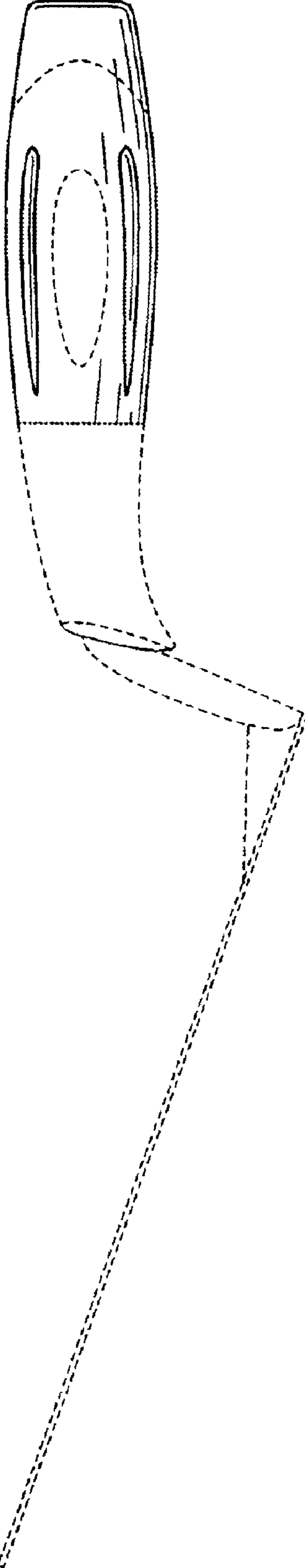

FIG. 2

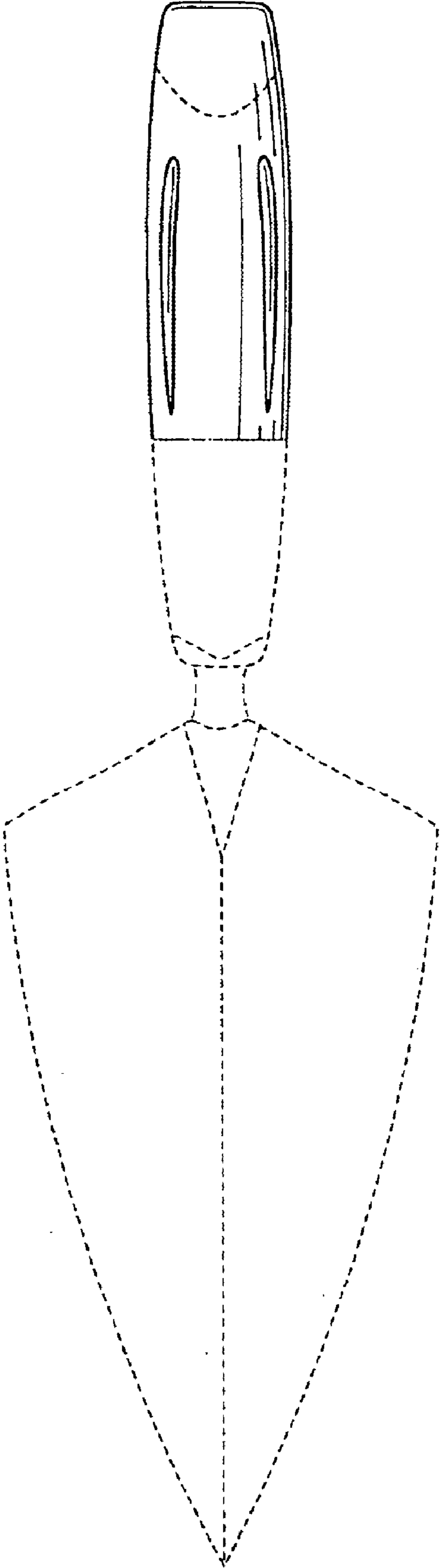

FIG. 3

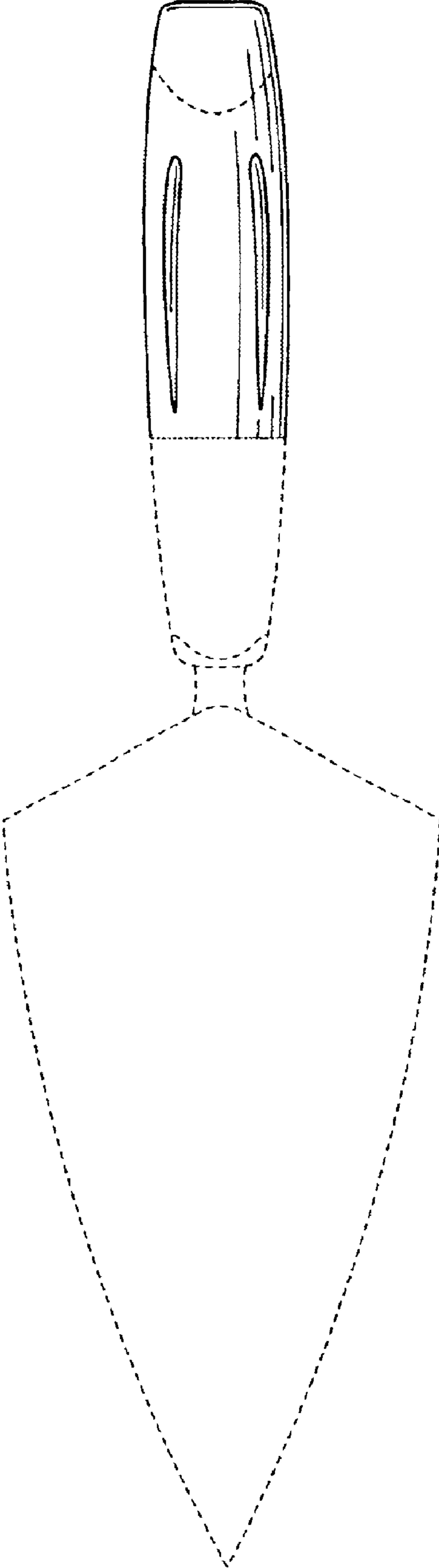

FIG. 4

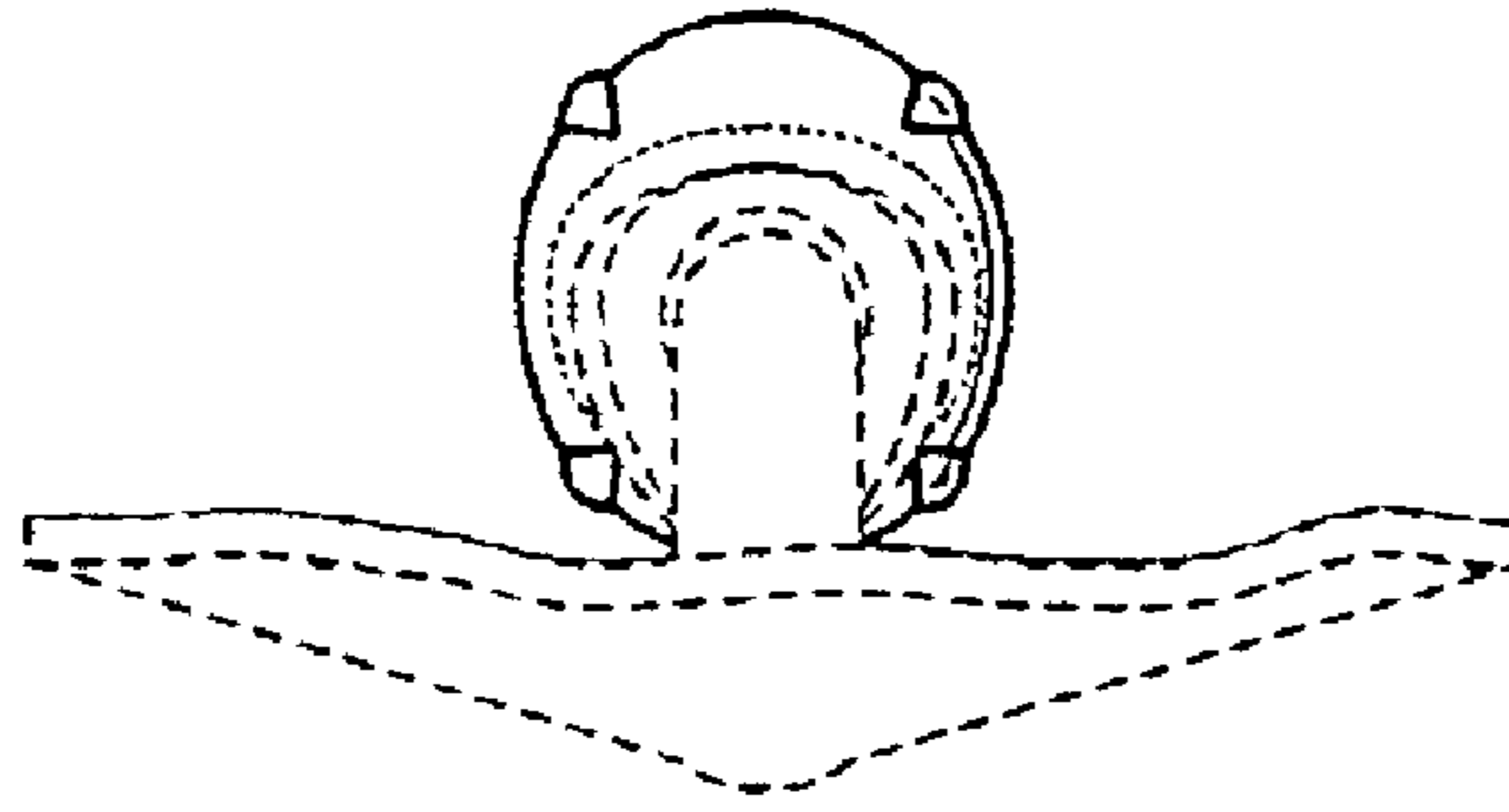

FIG. 5

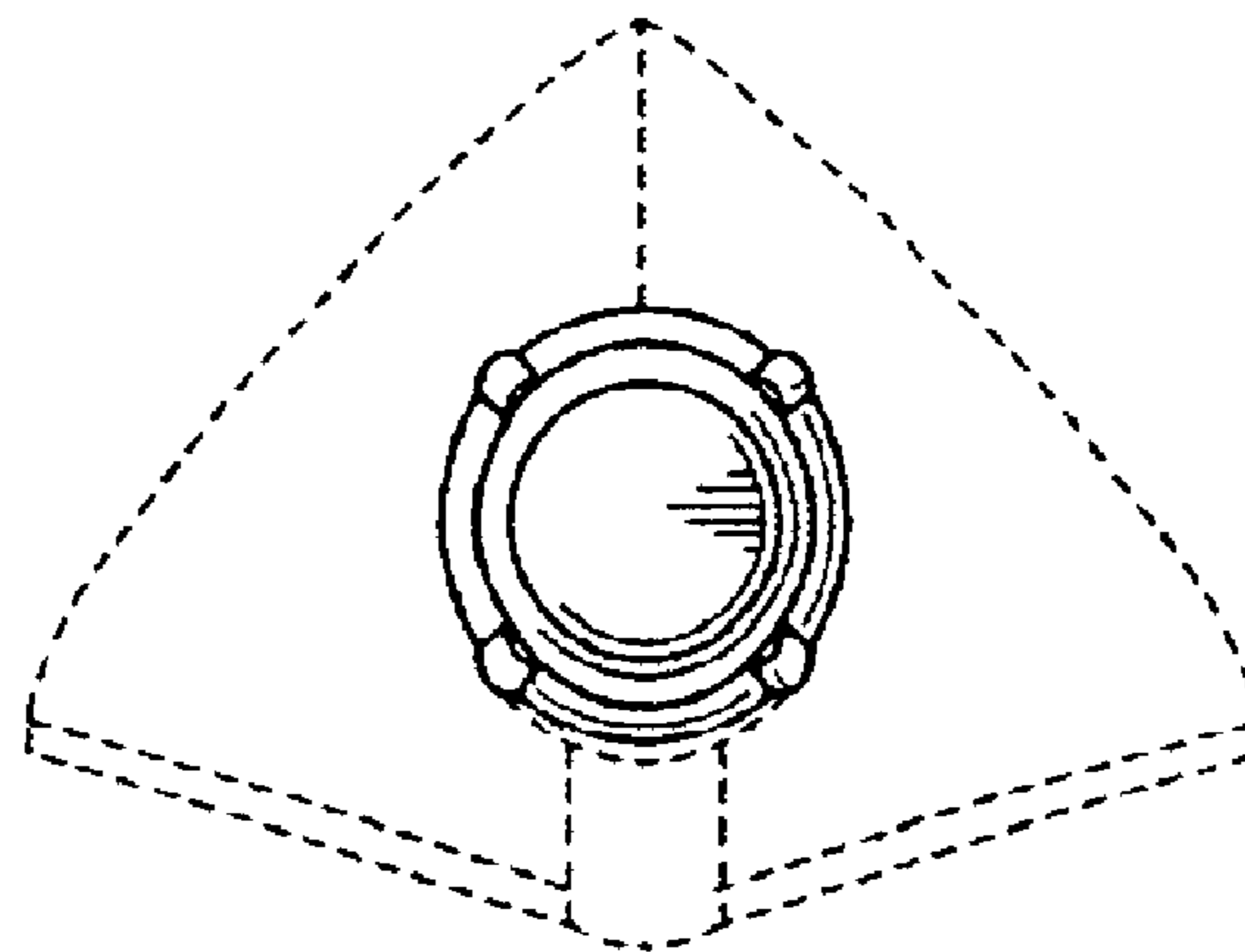
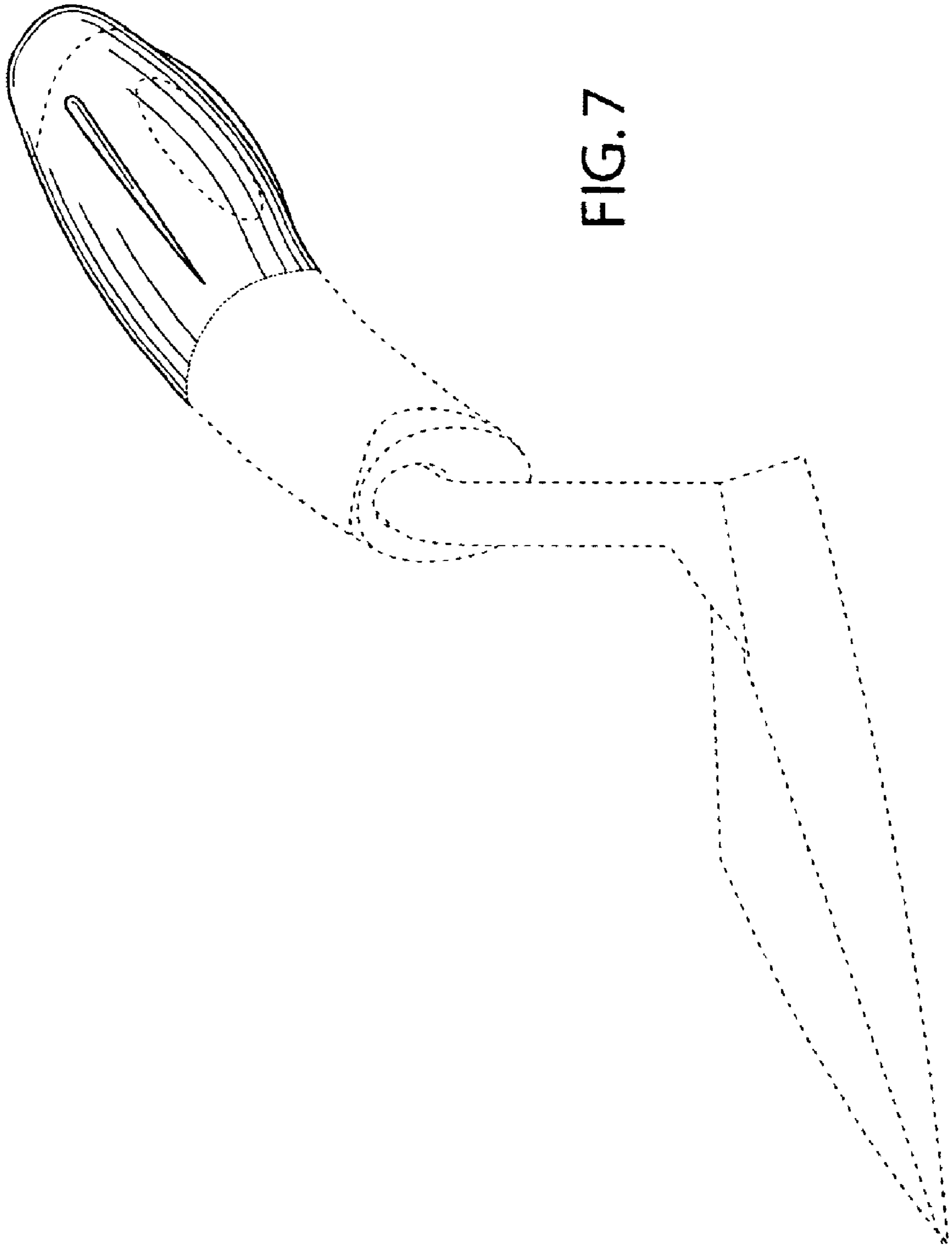

FIG. 6



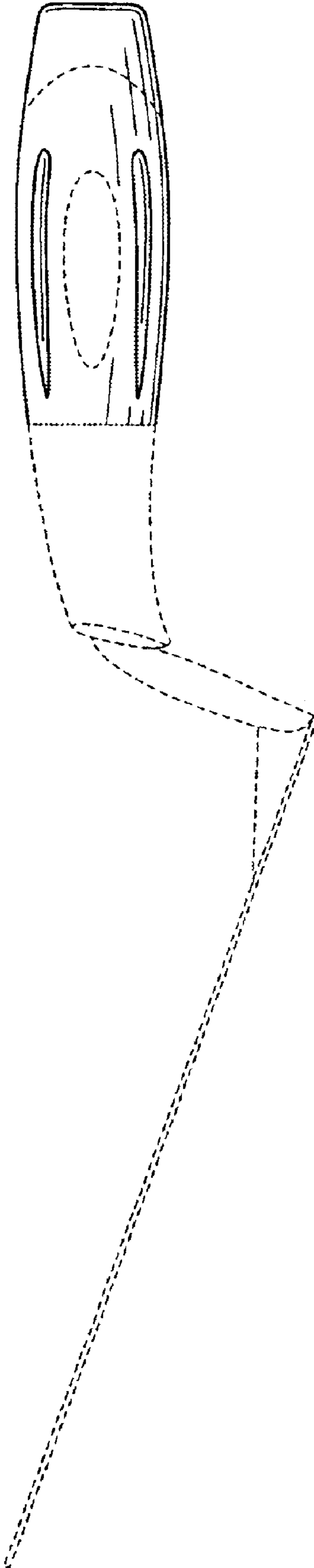

FIG. 8

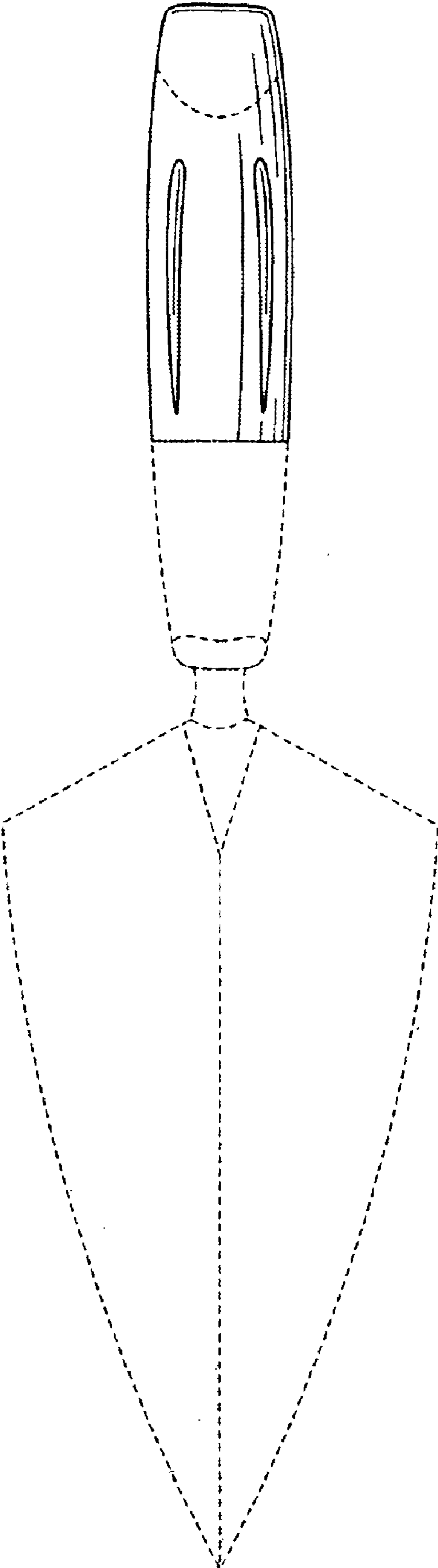

FIG. 9

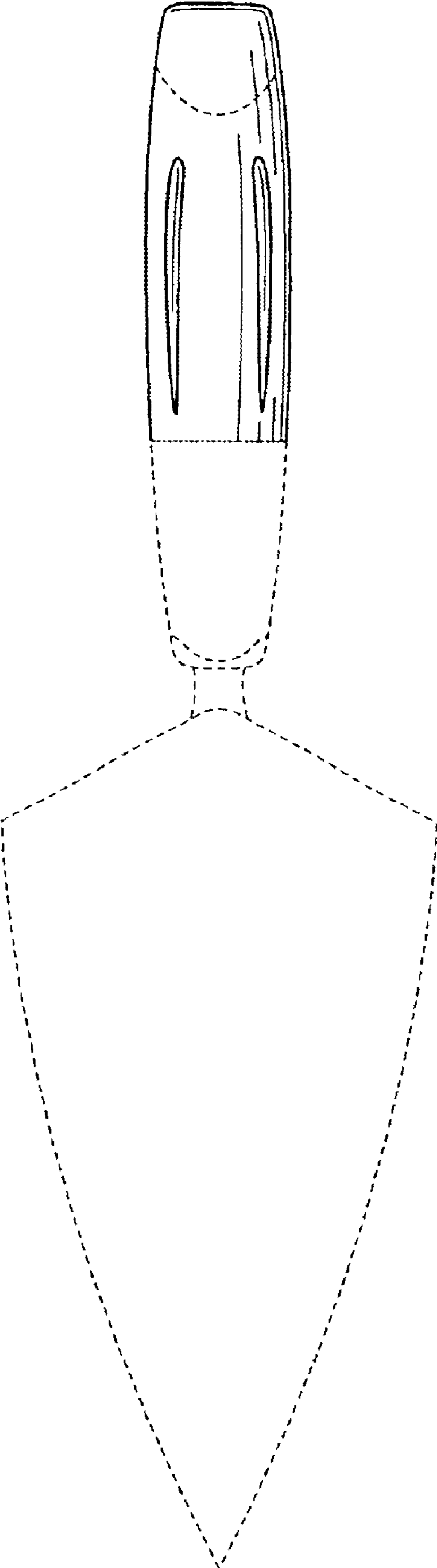

FIG. 10

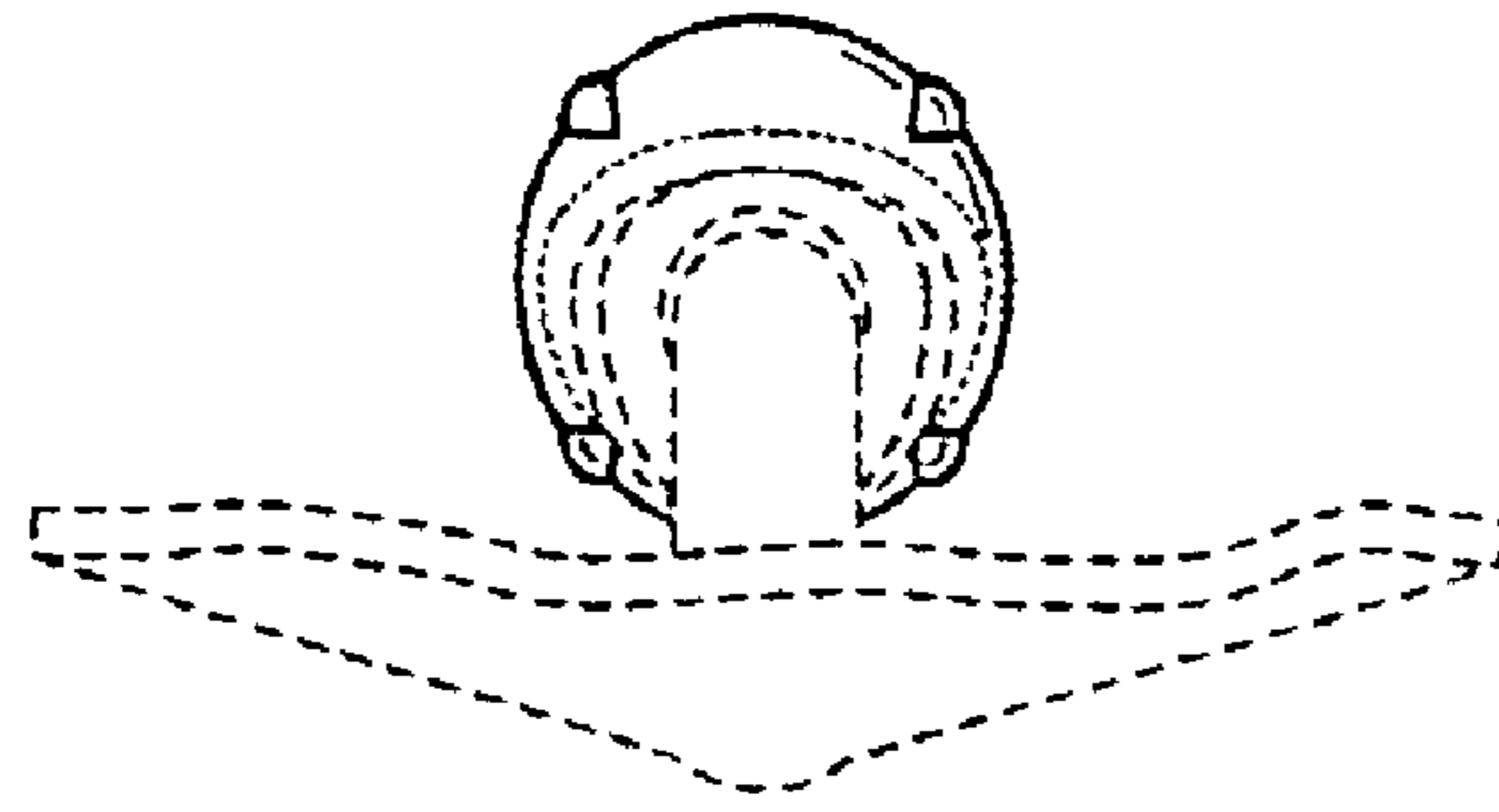

FIG. 11

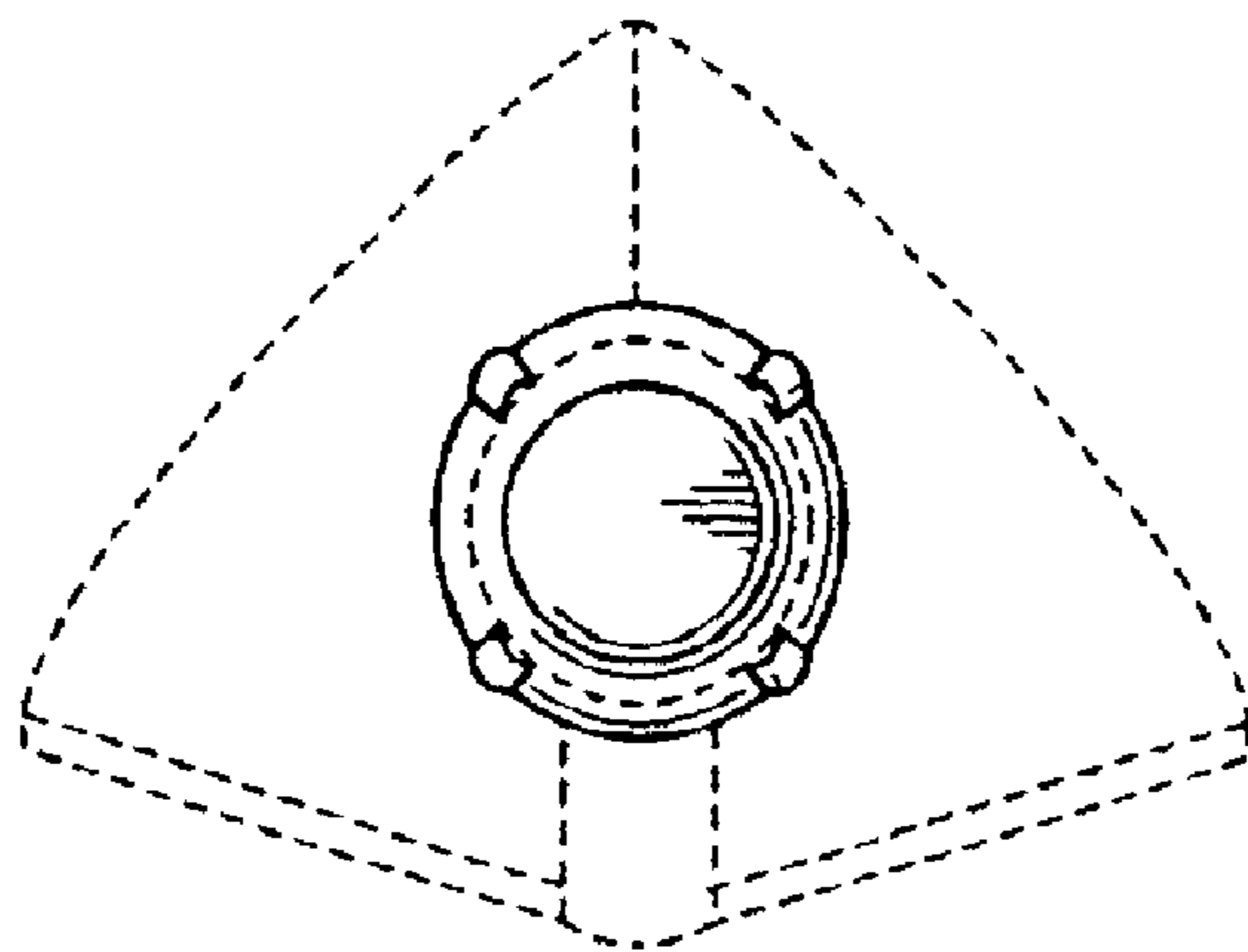

FIG. 12