

US00D509632S

(12) **United States Design Patent**  
**Shin**

(10) **Patent No.:** **US D509,632 S**

(45) **Date of Patent:** **\*\* Sep. 13, 2005**

(54) **VACUUM CLEANER**

(75) **Inventor:** **Hyon Seon Shin, Gyeonggi-do (KR)**

(73) **Assignee:** **LG Electronics Inc., Seoul (KR)**

(\*\*) **Term:** **14 Years**

(21) **Appl. No.:** **29/202,983**

(22) **Filed:** **Apr. 8, 2004**

(30) **Foreign Application Priority Data**

Oct. 9, 2003 (KR) ..... 30-2003-0028349

(51) **LOC (8) Cl.** ..... **15-05**

(52) **U.S. Cl.** ..... **D32/22**

(58) **Field of Search** ..... D32/22, 30-34;  
15/320-321, 347, 350-351, 353, 361, 410,  
412, 414, 246.2, DIG. 8; 55/318, 337, 400,  
DIG. 3, 429, 459.1, 345, 447; 95/271, 268;  
210/512.1, 512.2

(56) **References Cited**

**U.S. PATENT DOCUMENTS**

D347,500 S \* 5/1994 Abe et al. .... D32/22  
D398,098 S \* 9/1998 Mehaffey et al. .... D32/22

D403,480 S \* 12/1998 Diebel ..... D32/22  
D429,854 S \* 8/2000 Hohulin et al. .... D32/22  
D434,884 S \* 12/2000 Hohulin et al. .... D32/22  
D487,323 S \* 3/2004 Leyden et al. .... D32/22  
D494,720 S \* 8/2004 Rosenzweig et al. .... D32/31  
D499,220 S \* 11/2004 Kim ..... D32/22  
D501,965 S \* 2/2005 Ikeno et al. .... D32/22

\* cited by examiner

*Primary Examiner*—Ruth McInroy

(74) *Attorney, Agent, or Firm*—Birch, Stewart, Kolasch & Birch, LLP

(57) **CLAIM**

The ornamental design for vacuum cleaner, as shown and described.

**DESCRIPTION**

FIG. 1 is a perspective view of the vacuum cleaner;  
FIG. 2 is a front view thereof;  
FIG. 3 is a rear view thereof;  
FIG. 4 is a left side view thereof;  
FIG. 5 is a right side view thereof;  
FIG. 6 is a top plan view thereof; and,  
FIG. 7 is a bottom plan view thereof.

**1 Claim, 6 Drawing Sheets**

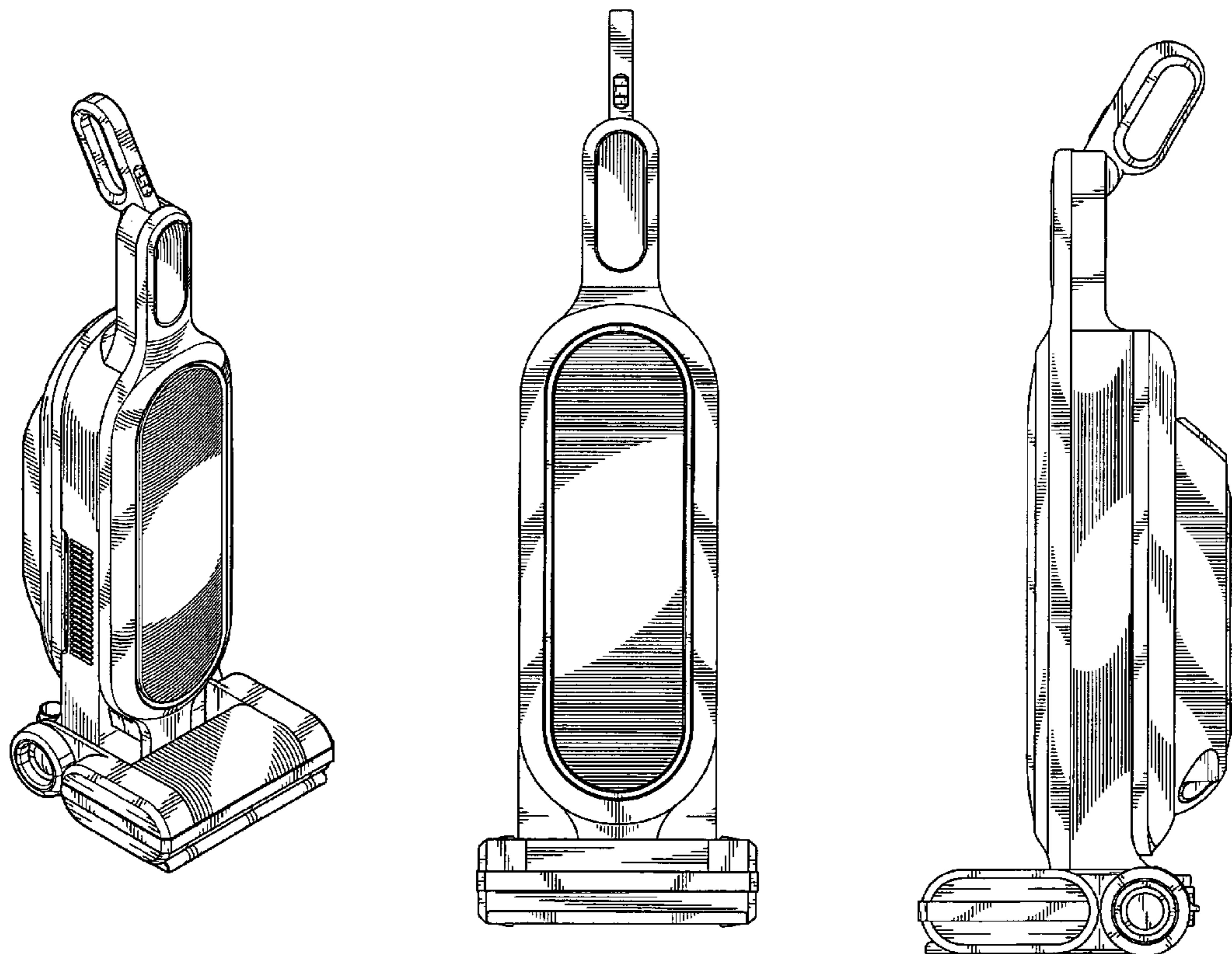

FIG. 1

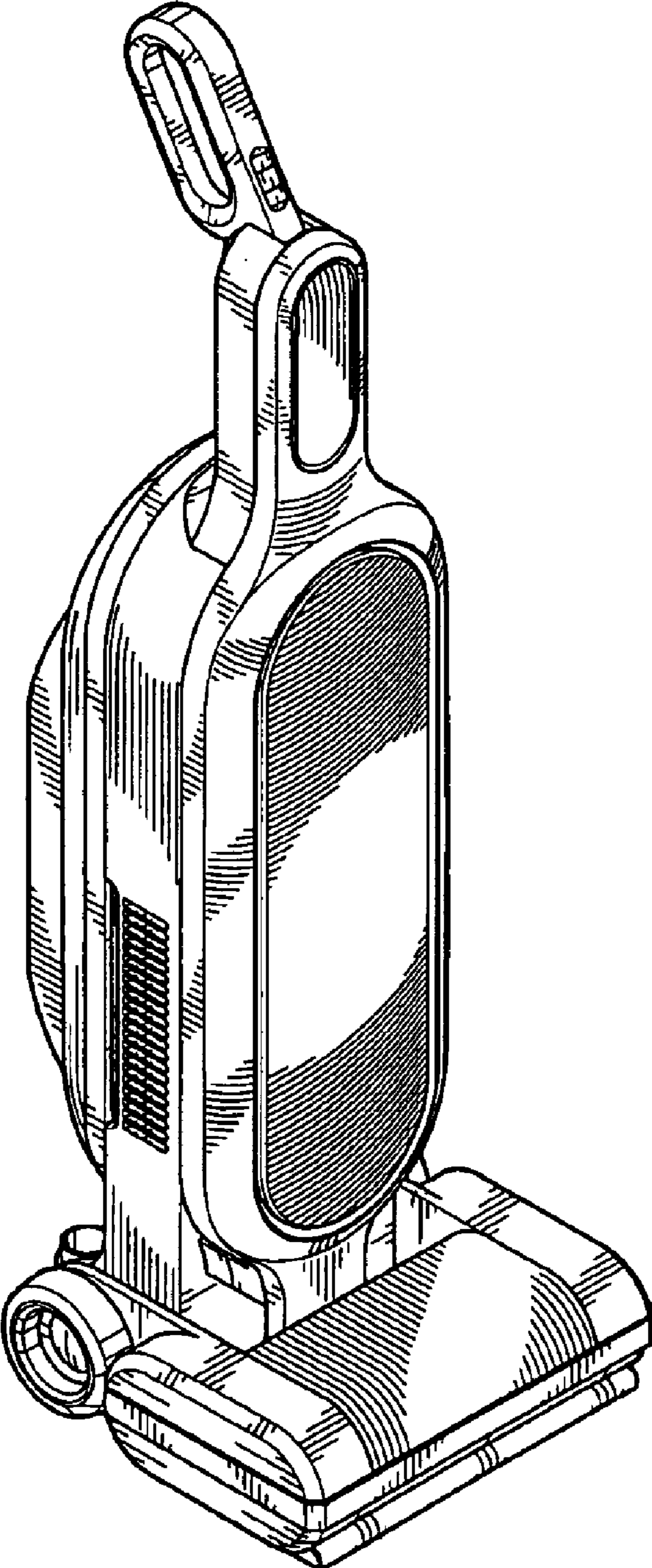

FIG. 2

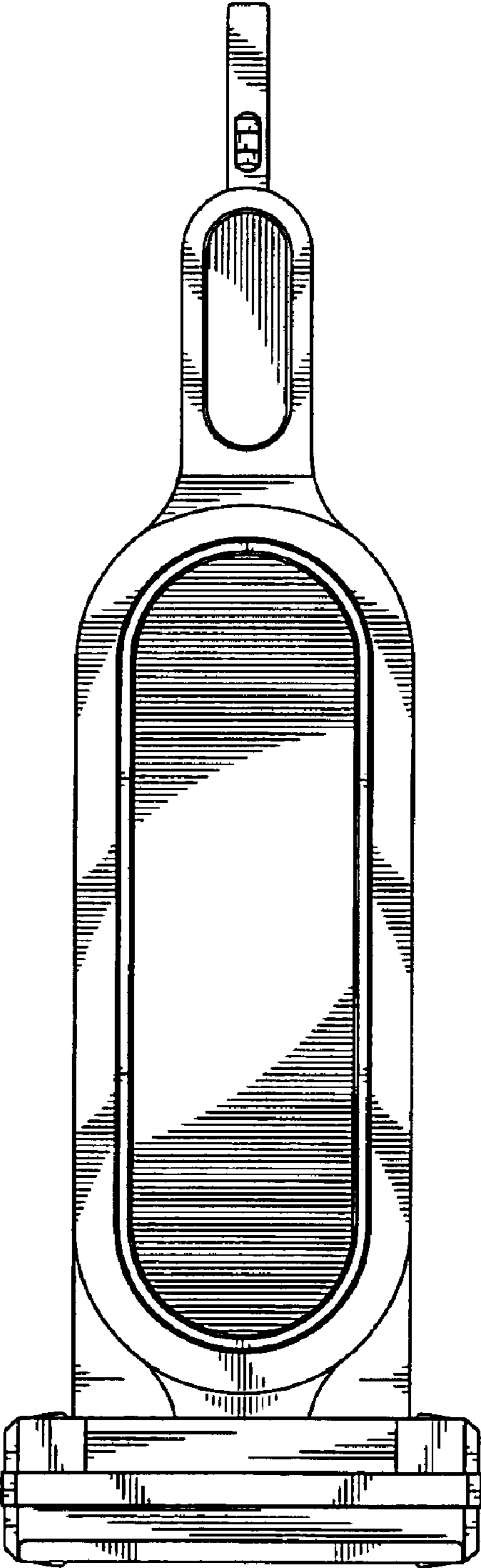

FIG. 3

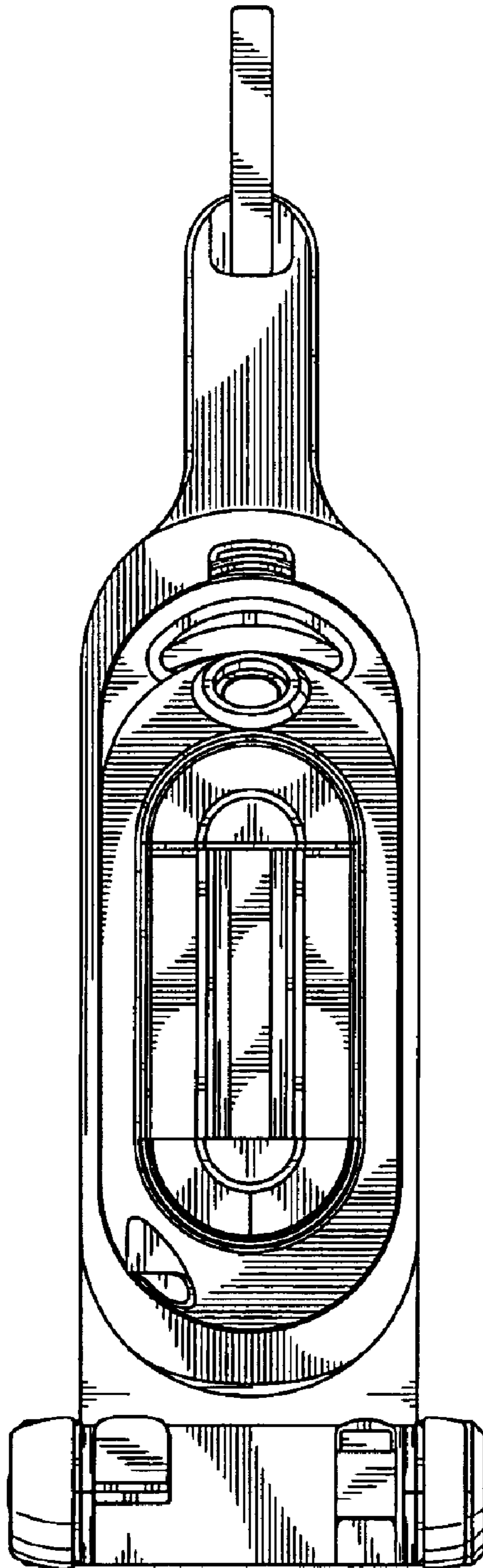

FIG. 4

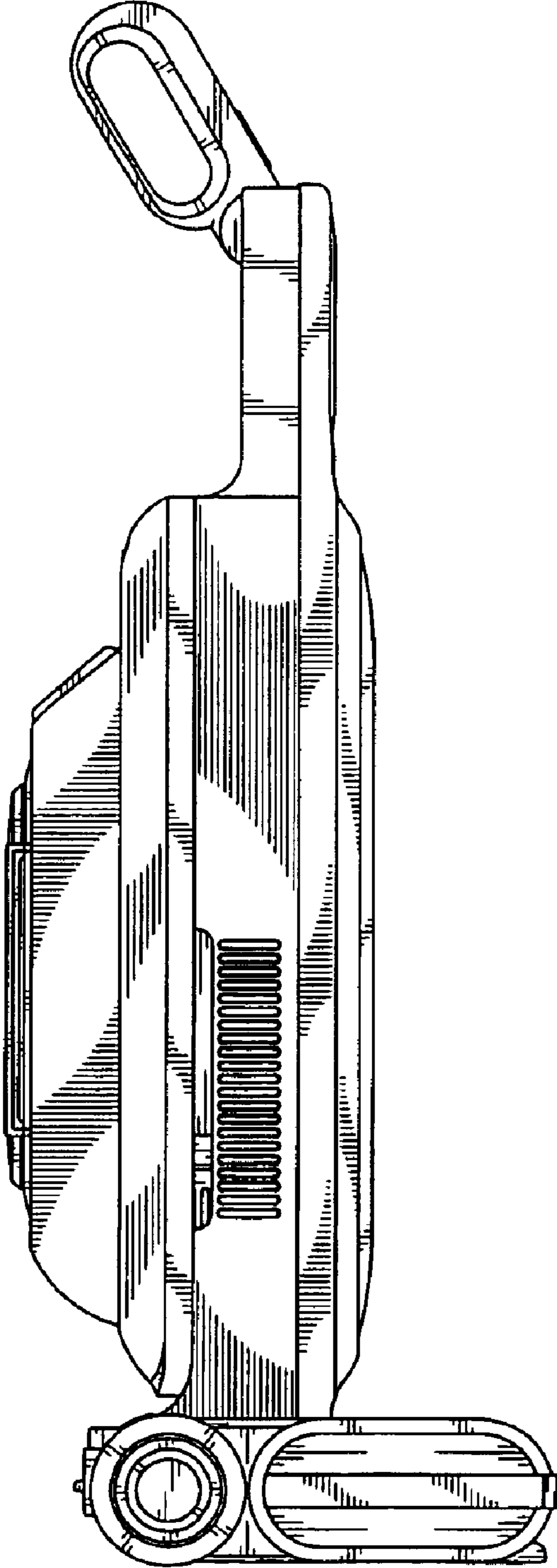

FIG. 5

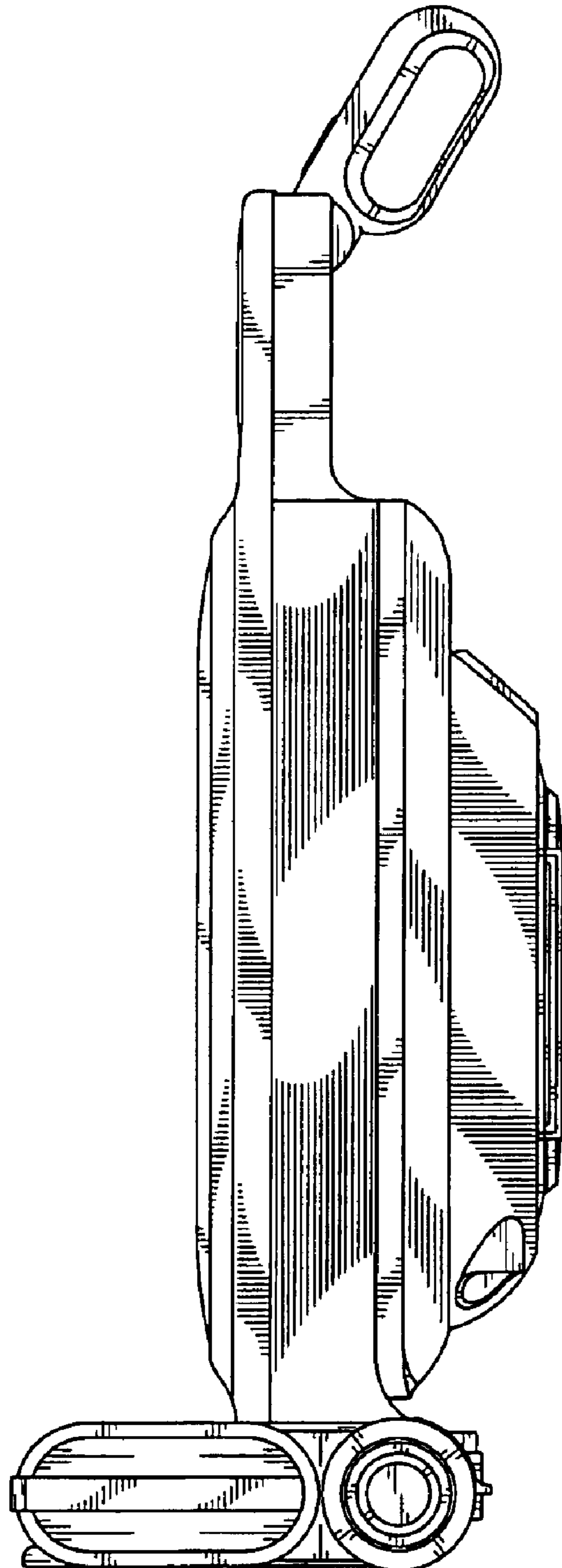

FIG. 6

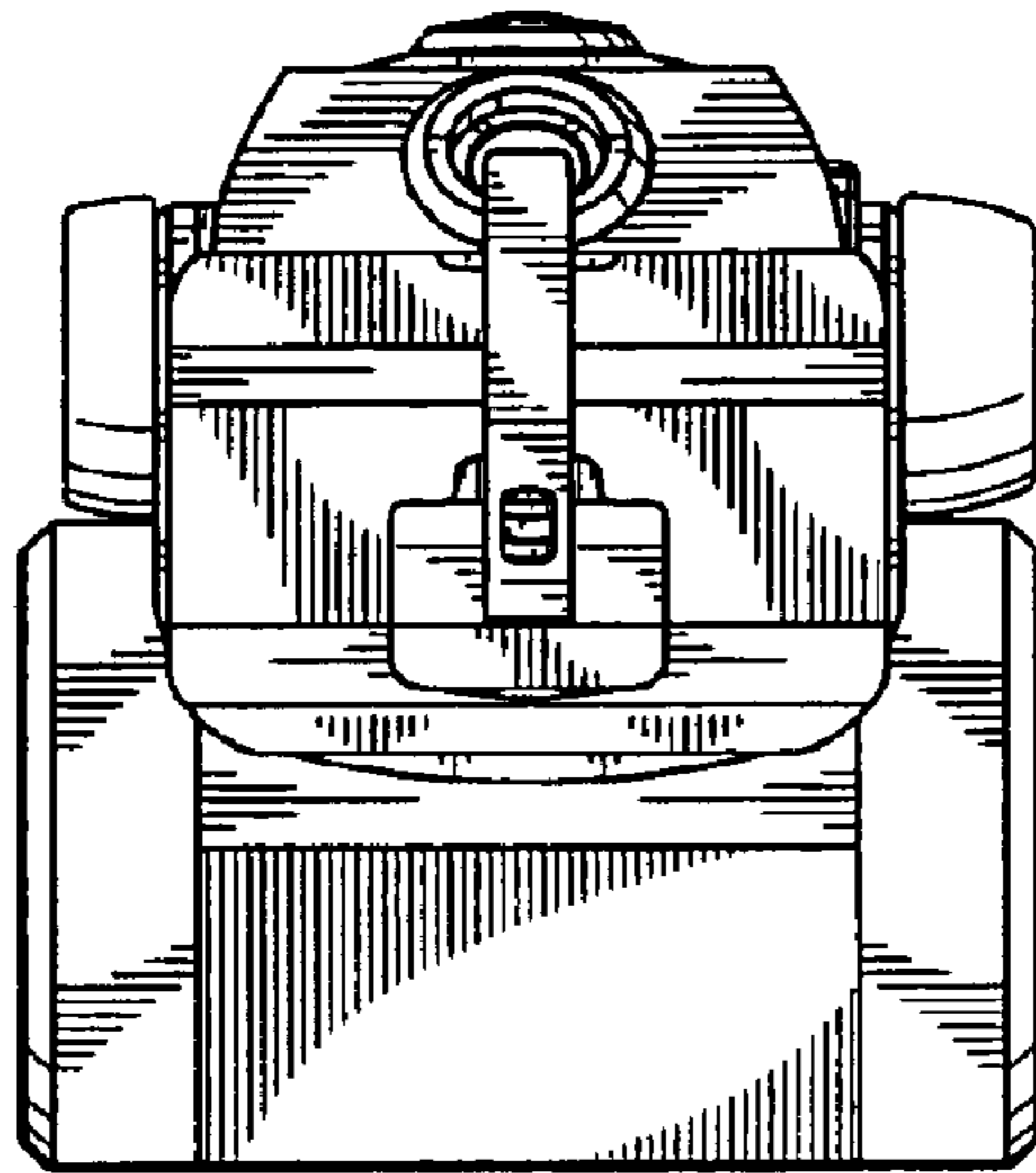

FIG. 7

