

US00D509607S

(12) **United States Design Patent**  
**Egawa**

(10) **Patent No.: US D509,607 S**  
(45) **Date of Patent: \*\* Sep. 13, 2005**

(54) **FLUORESCENT LAMP**

D447,823 S \* 9/2001 Choi ..... D26/3  
D464,154 S \* 10/2002 Xu ..... D26/3

(75) Inventor: **Kazuo Egawa, Tokyo (JP)**

\* cited by examiner

(73) Assignee: **Toshiba Lighting & Technology Corporation, Tokyo (JP)**

*Primary Examiner*—Marcus A. Jackson  
(74) *Attorney, Agent, or Firm*—J.C. Patents

(\*\*) Term: **14 Years**

(57) **CLAIM**

(21) Appl. No.: **29/210,099**

The ornamental design for a fluorescent lamp, as shown and described.

(22) Filed: **Jul. 26, 2004**

**DESCRIPTION**

(30) **Foreign Application Priority Data**

Jan. 28, 2004 (JP) ..... 2004-001988

FIG. 1 is a perspective view of a fluorescent lamp showing the new design.

(51) **LOC (8) Cl.** ..... **26-04**

FIG. 2 is a front view thereof.

(52) **U.S. Cl.** ..... **D26/3**

FIG. 3 is a rear view thereof.

(58) **Field of Search** ..... D26/1-4; 313/110,  
313/315, 317, 318, 491, 567, 569; 315/56,  
57, 58, 73

FIG. 4 is a left side view thereof.

FIG. 5 is a right side view thereof.

FIG. 6 is a top view thereof.

FIG. 7 is a bottom view thereof.

(56) **References Cited**

**U.S. PATENT DOCUMENTS**

D422,371 S \* 4/2000 Kato et al. .... D26/3  
D430,318 S \* 8/2000 Choi ..... D26/3

FIG. 8 is an end view in section taken along line 8—8 in FIG. 2 with the internal parts omitted; and,

FIG. 9 is an end view in section taken along line 9—9 in FIG. 2 with the internal parts omitted.

**1 Claim, 9 Drawing Sheets**

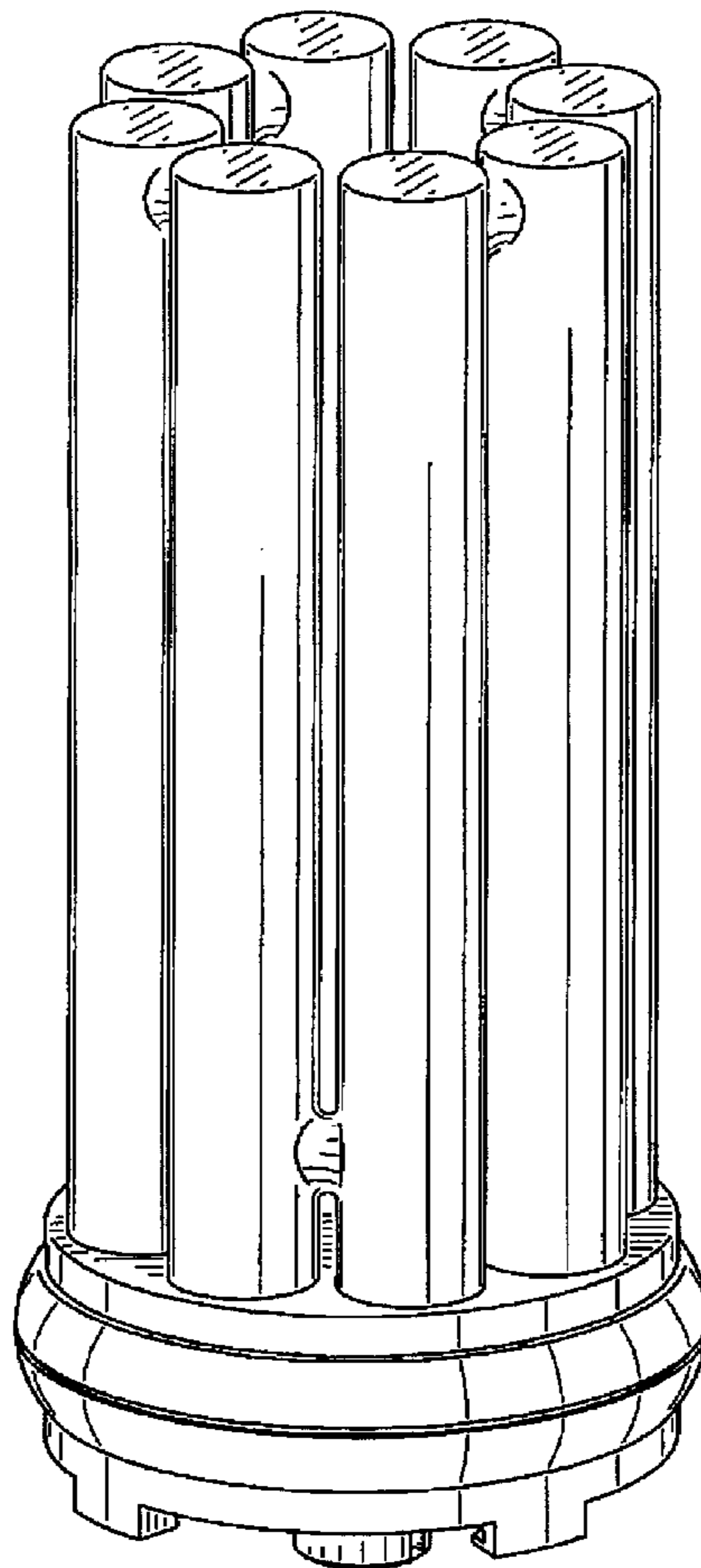

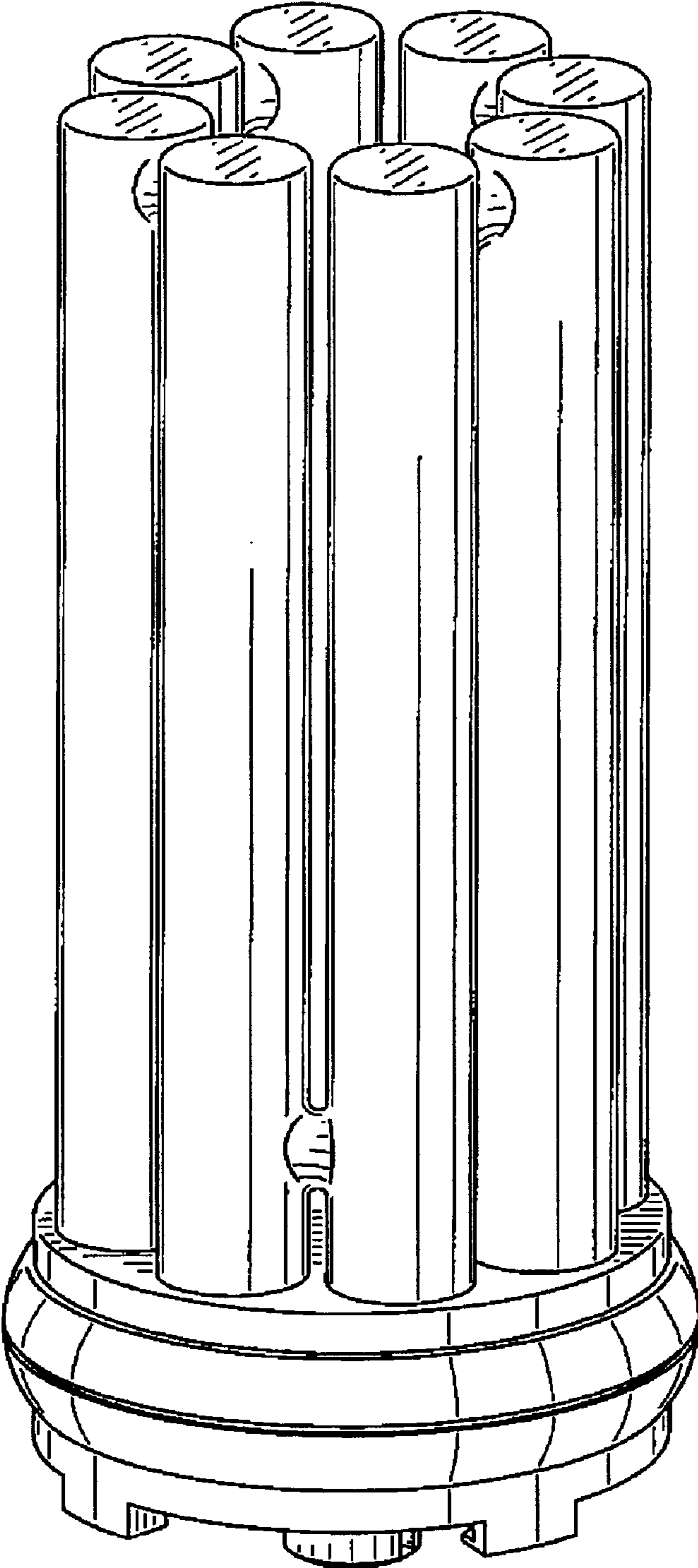

FIG. 1

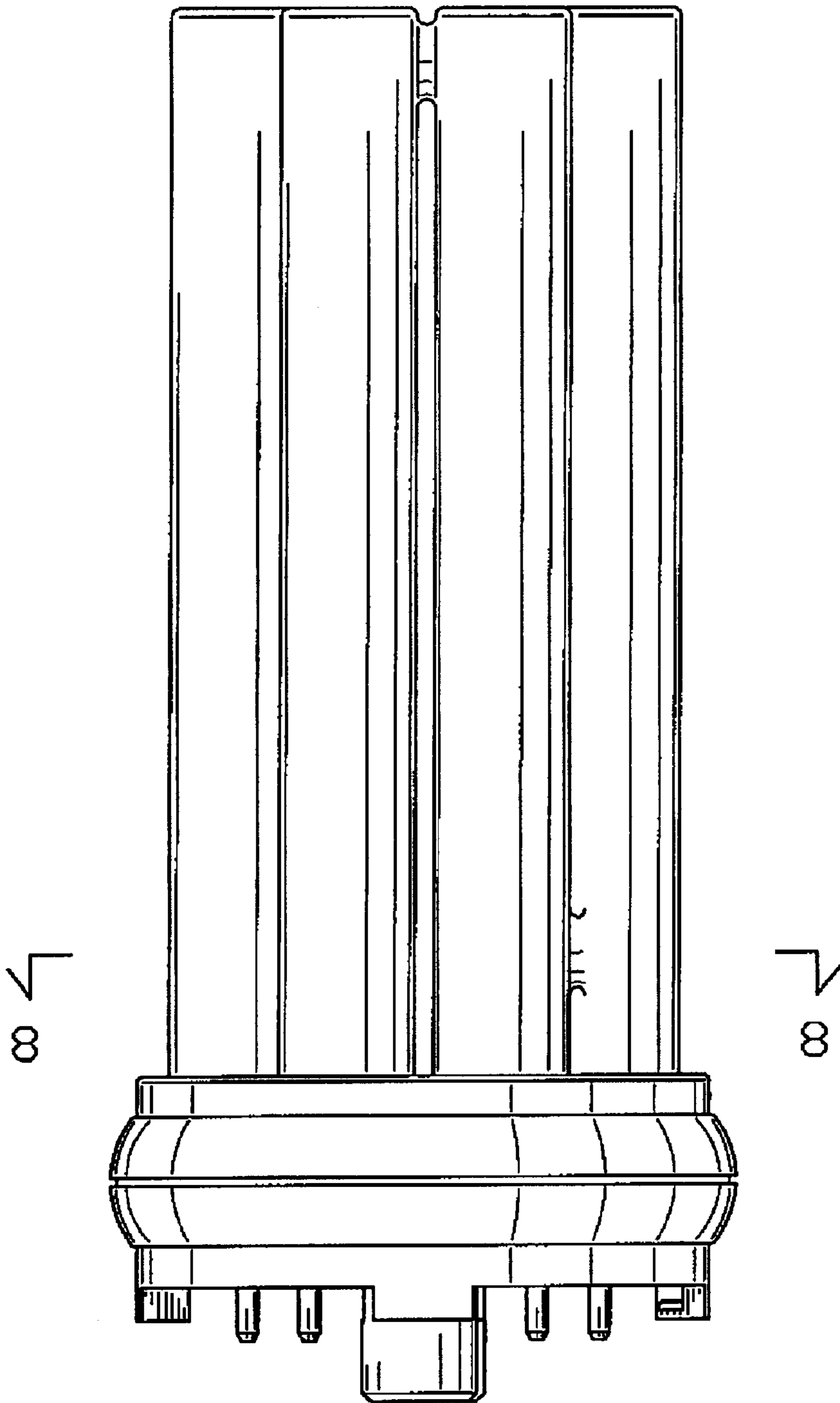

FIG. 2

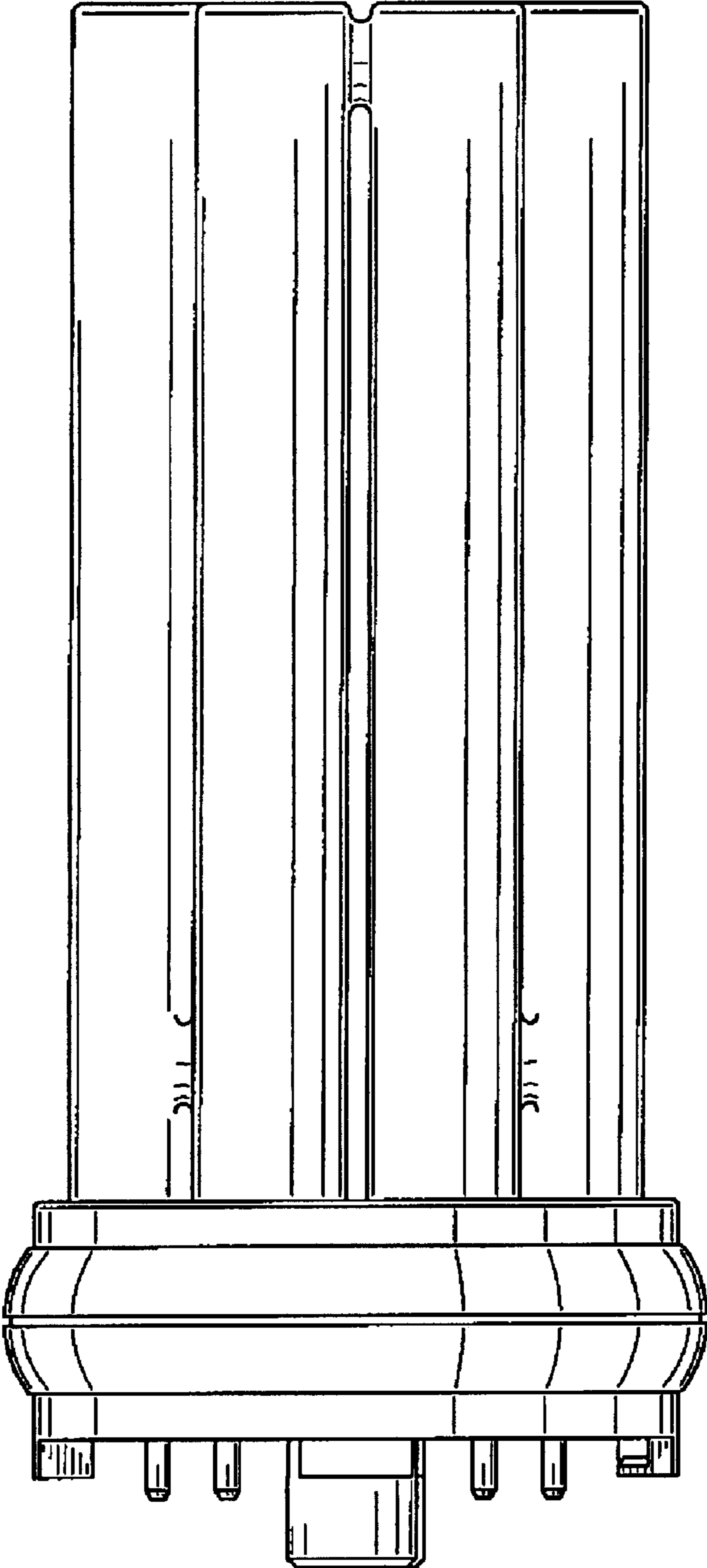

FIG. 3

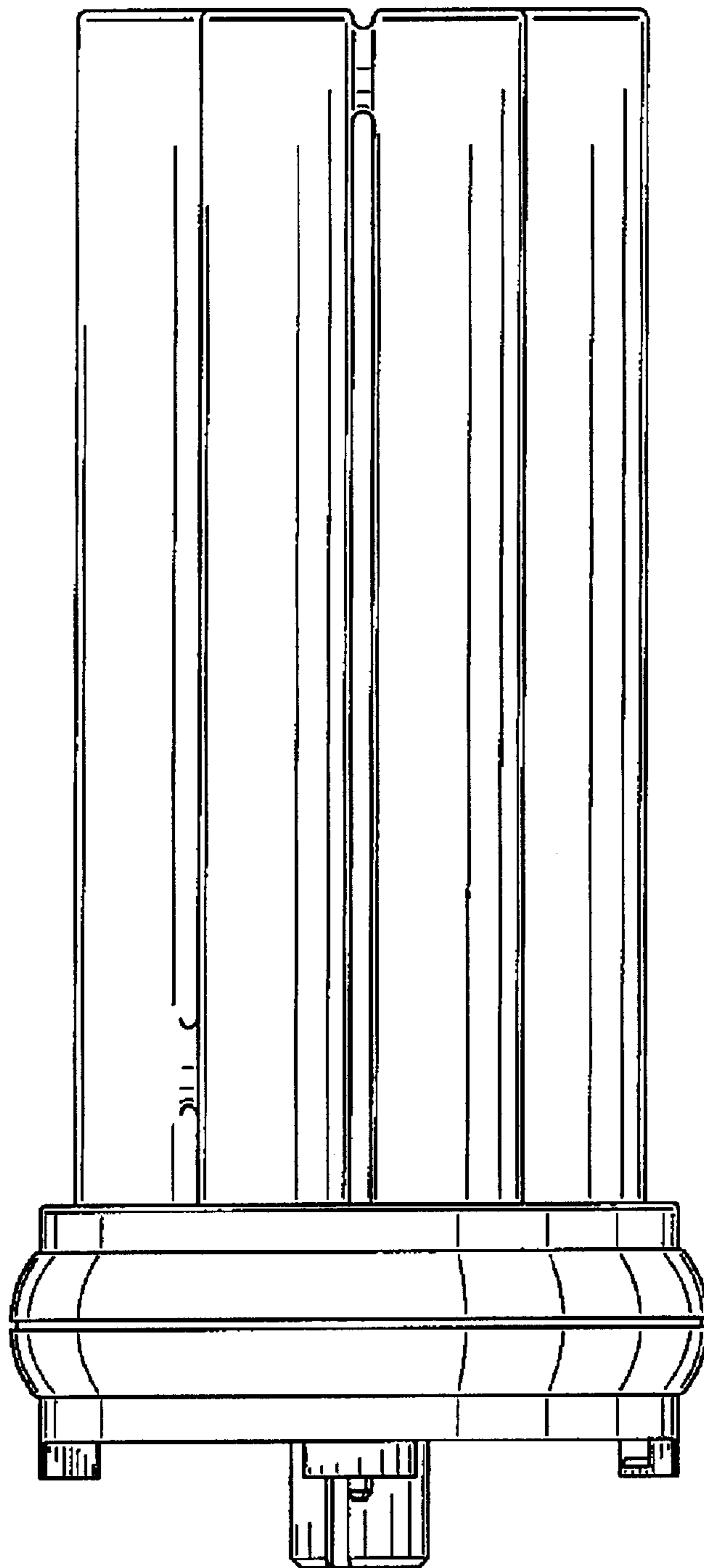

FIG. 4

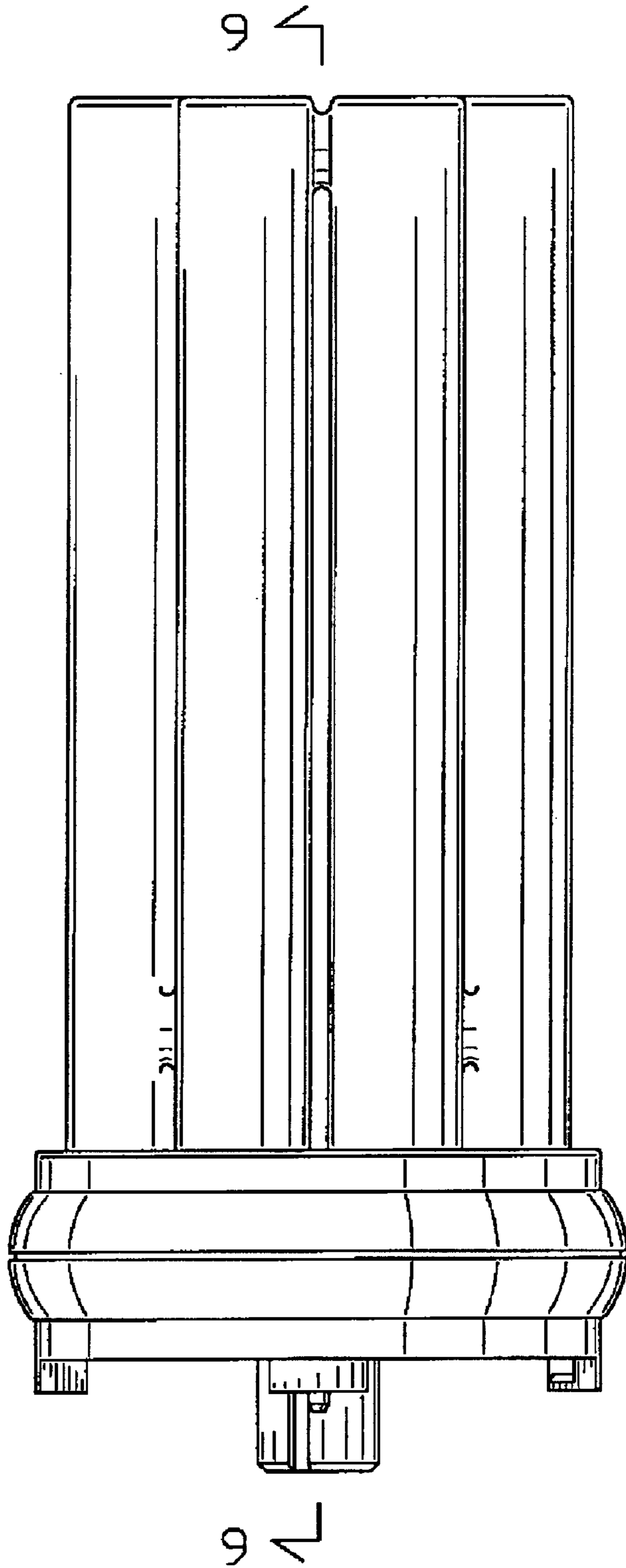

FIG. 5

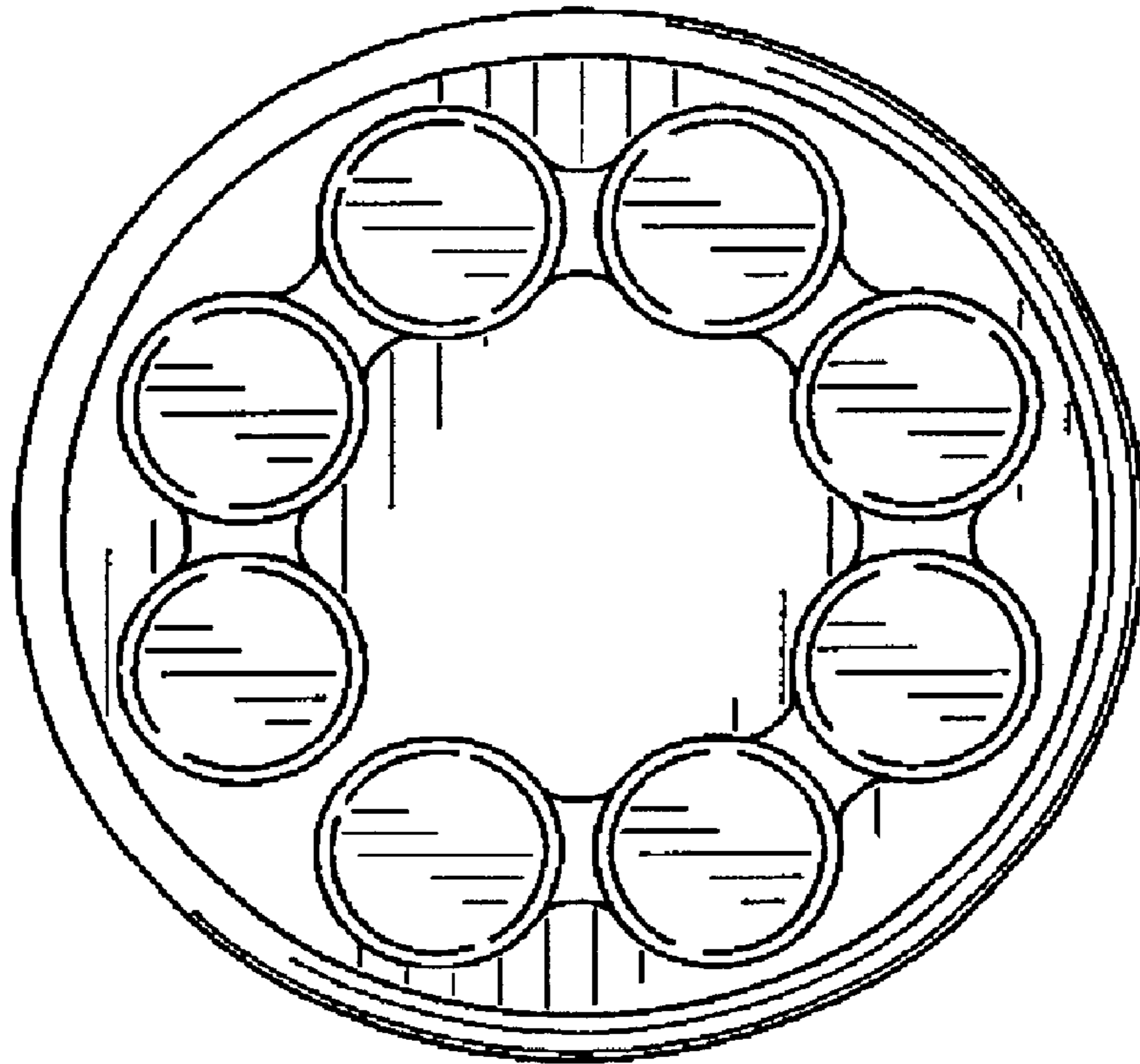

FIG. 6

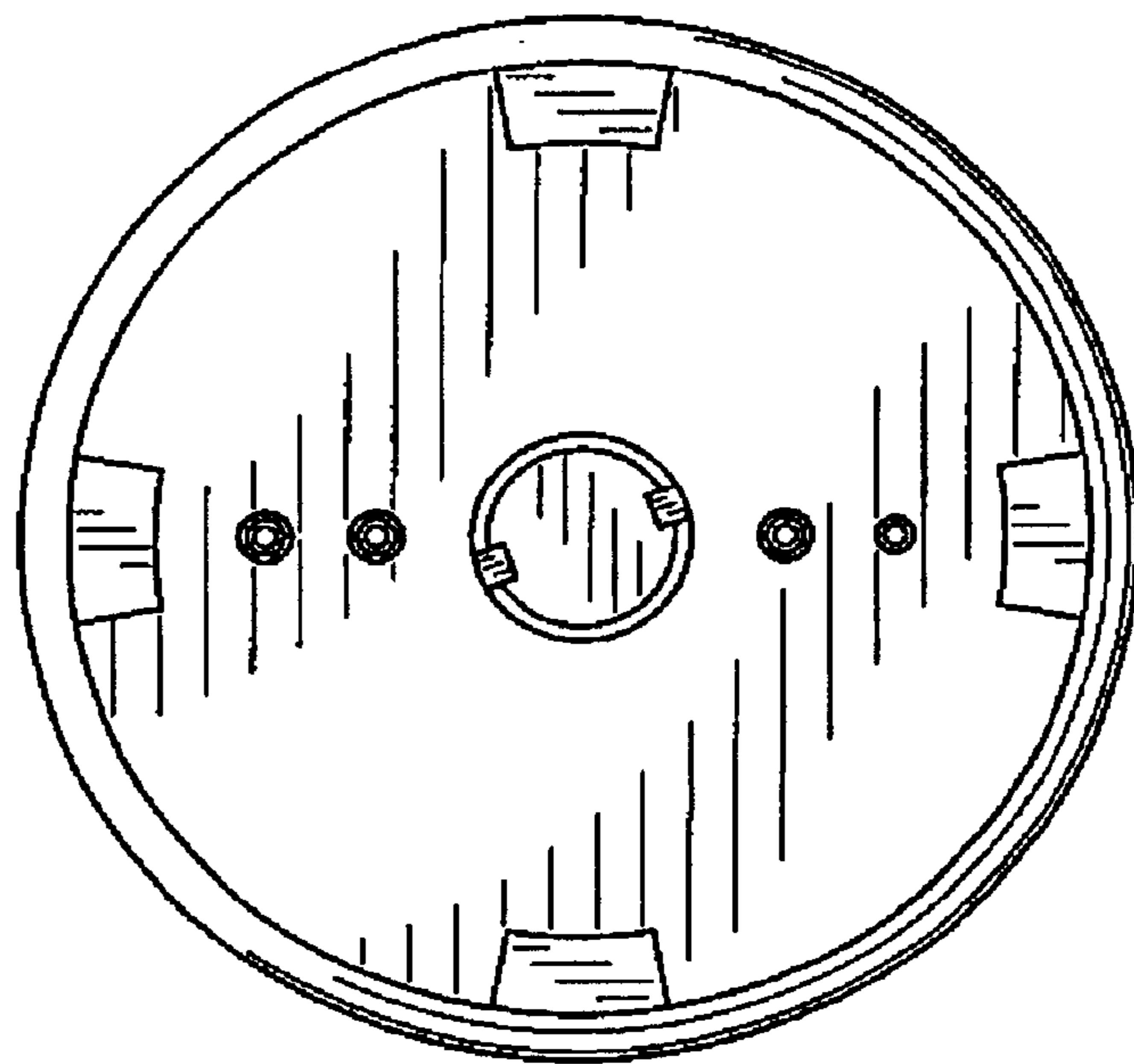

FIG. 7



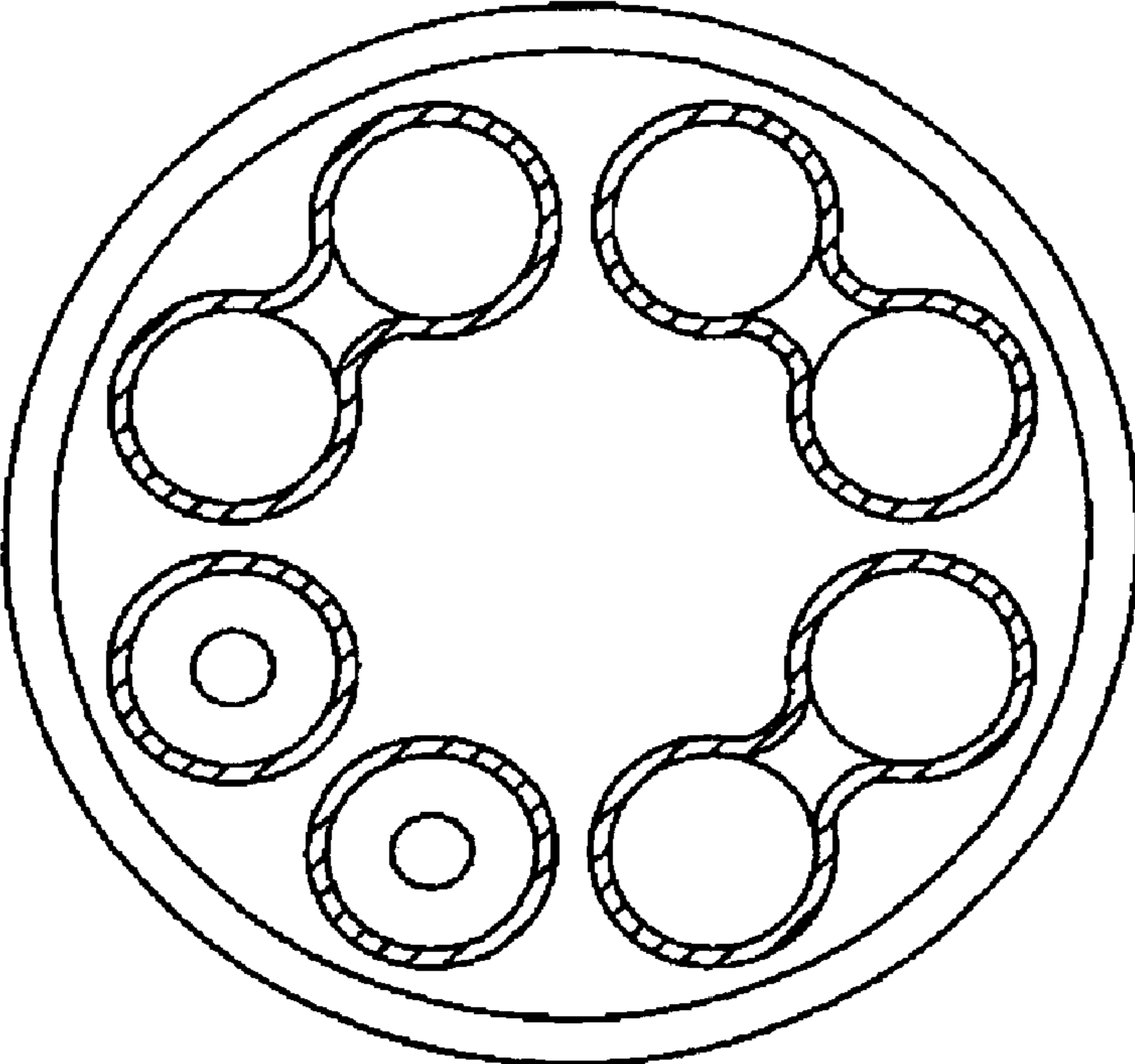

FIG. 8

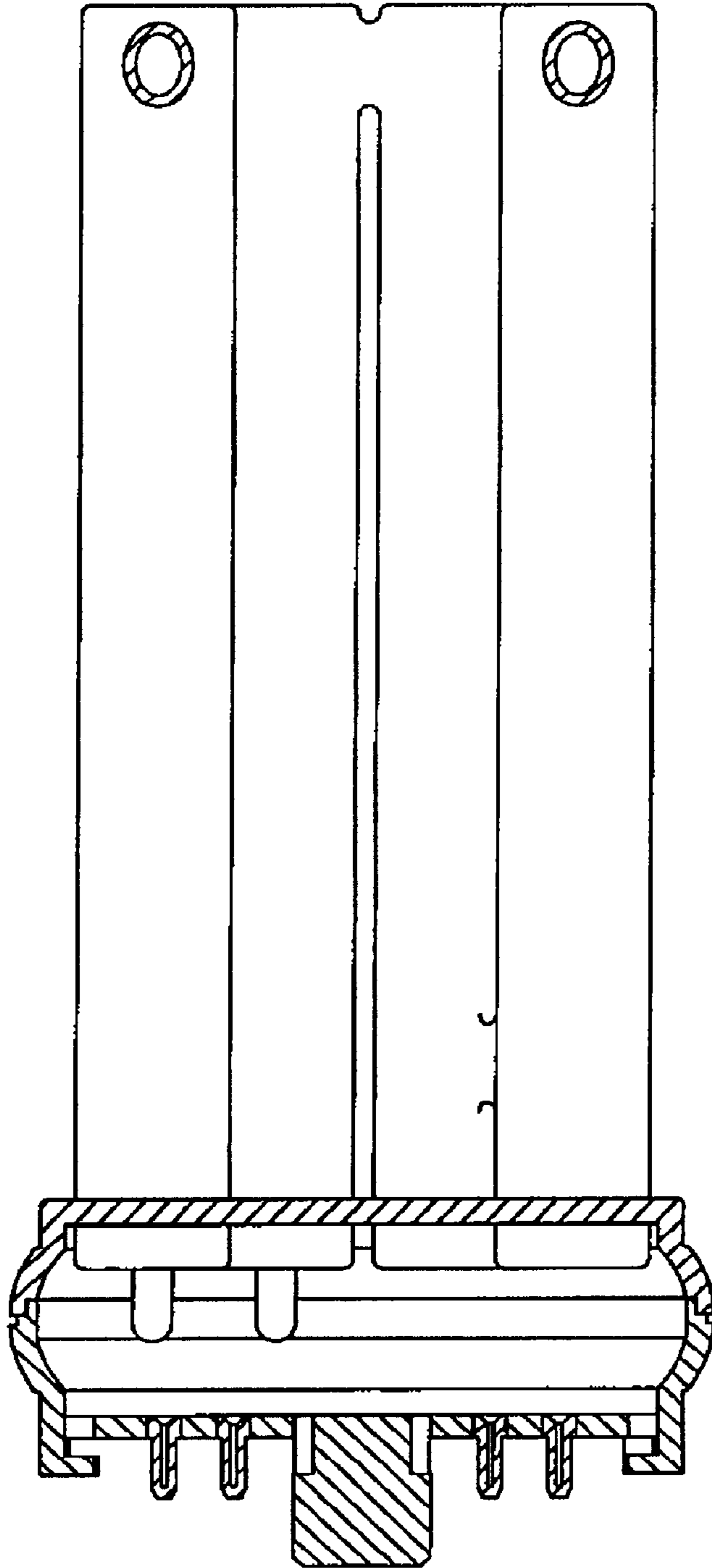

FIG. 9