



US00D509577S

(12) **United States Design Patent**
Loberger et al.

(10) **Patent No.: US D509,577 S**
(45) **Date of Patent: ** Sep. 13, 2005**

(54) **LAVATORY**

(75) Inventors: **John M. Loberger**, Germantown, WI (US); **Jason M. Renner**, Milwaukee, WI (US)

(73) Assignee: **Bradley Fixtures Corporation**, Menomonee Falls, WI (US)

(**) Term: **14 Years**

(21) Appl. No.: **29/200,657**

(22) Filed: **Mar. 2, 2004**

(51) **LOC (8) Cl.** **23-02**

(52) **U.S. Cl.** **D23/308**

(58) **Field of Search** D23/270-273, D23/286-290, 293.1, 303, 308; 4/662-665, 630-631, 637-643, 661; D6/511, 486; 108/50.01

(56) **References Cited**

U.S. PATENT DOCUMENTS

D426,988 S * 6/2000 Desombre D6/486

* cited by examiner

Primary Examiner—Robert A. Delehanty

(74) *Attorney, Agent, or Firm*—Foley & Lardner LLP

(57) **CLAIM**

We claim the ornamental design for a lavatory, as shown and described.

DESCRIPTION

FIG. 1 is a perspective view of a second embodiment of a lavatory.

FIG. 2 is a top plan view of the lavatory of FIG. 1.

FIG. 3 is a front elevation view of the lavatory of FIG. 1.

FIG. 4 is a bottom plan view of the lavatory of FIG. 1.

FIG. 5 is a rear elevation view of the lavatory of FIG. 1.

FIG. 6 is a left-side elevation view of the lavatory of FIG. 1.

FIG. 7 is a right-side elevation view of the lavatory of FIG. 1.

FIG. 8 is a perspective view of a second embodiment of a lavatory.

FIG. 9 is a top plan view of the lavatory of FIG. 8.

FIG. 10 is a front elevation view of the lavatory of FIG. 8.

FIG. 11 is a bottom plan view of the lavatory of FIG. 8.

FIG. 12 is a rear elevation view of the lavatory of FIG. 8.

FIG. 13 is a left-side elevation view of the lavatory of FIG. 8; and,

FIG. 14 is a right-side elevation view of the lavatory of FIG. 8.

The ornamental design which is claimed is shown in solid lines in the drawings. The broken lines in the drawings are for illustrative purposes only and form no part of the claimed design.

1 Claim, 6 Drawing Sheets

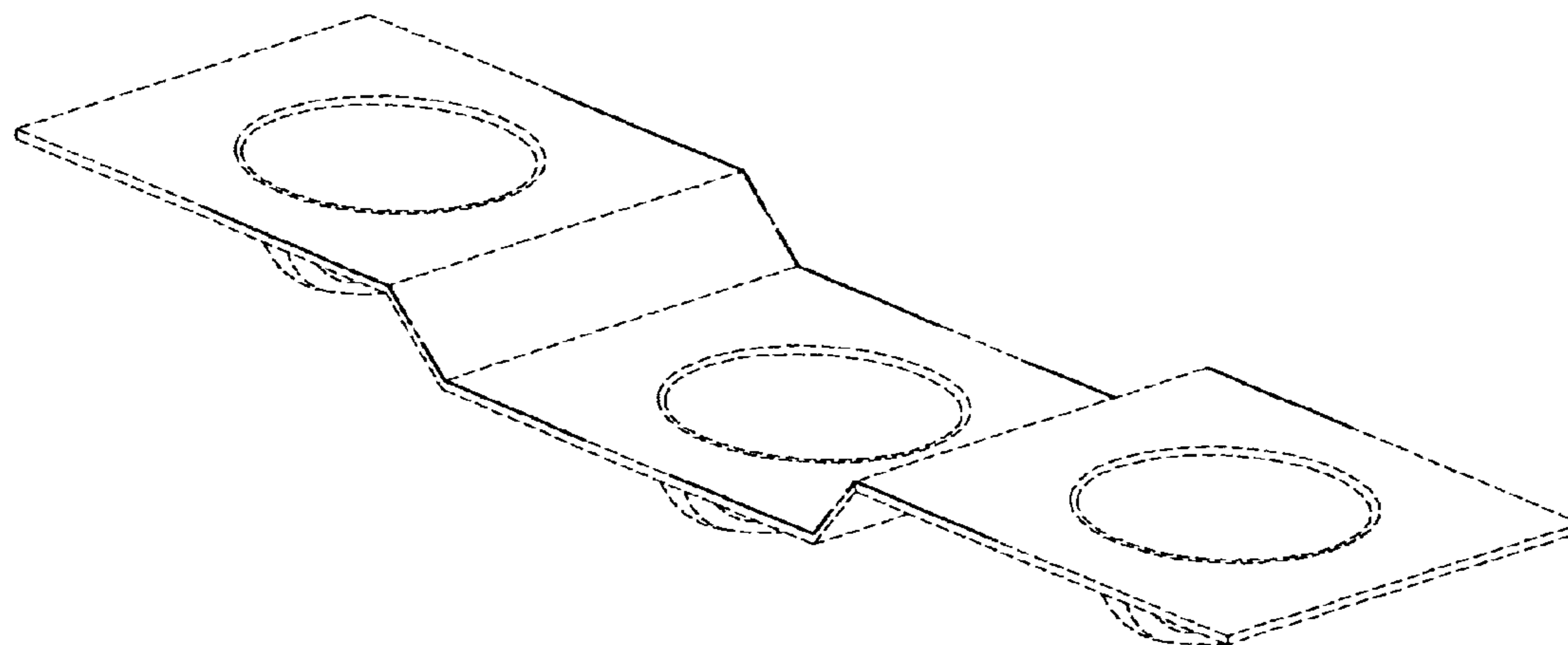

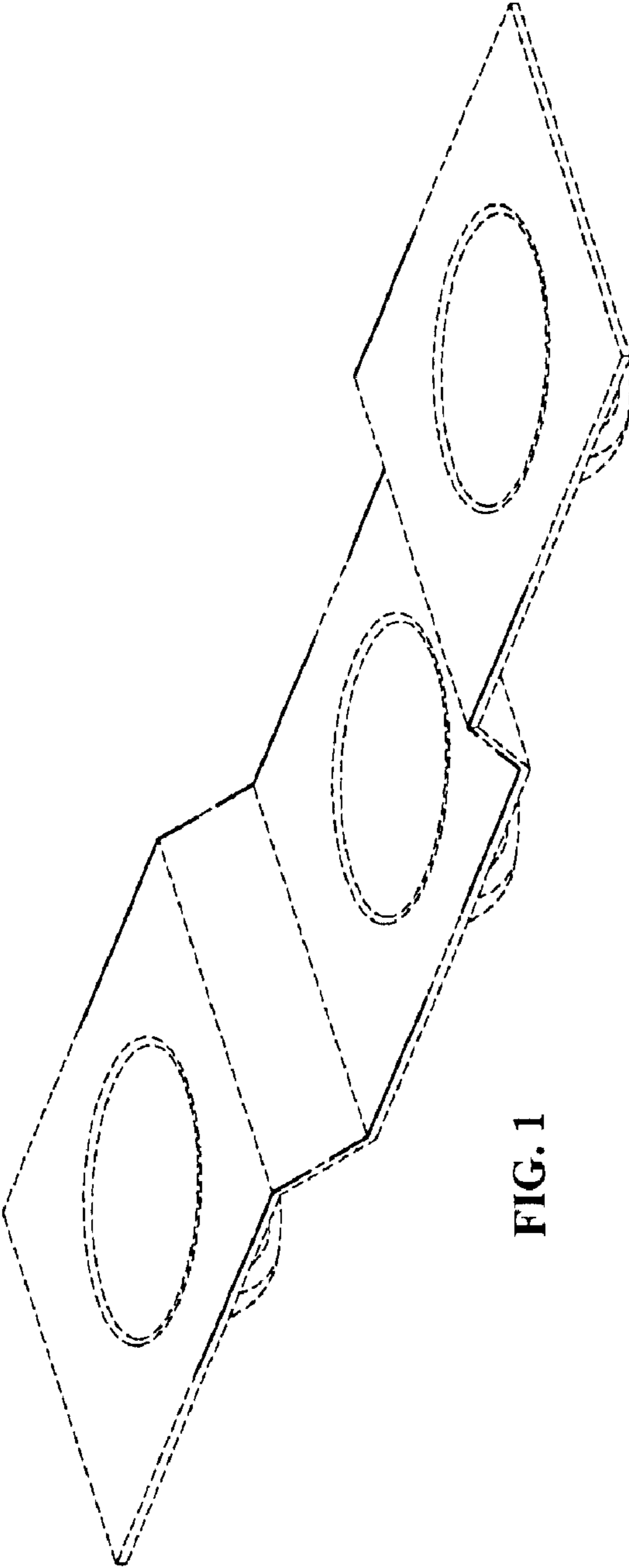

FIG. 1

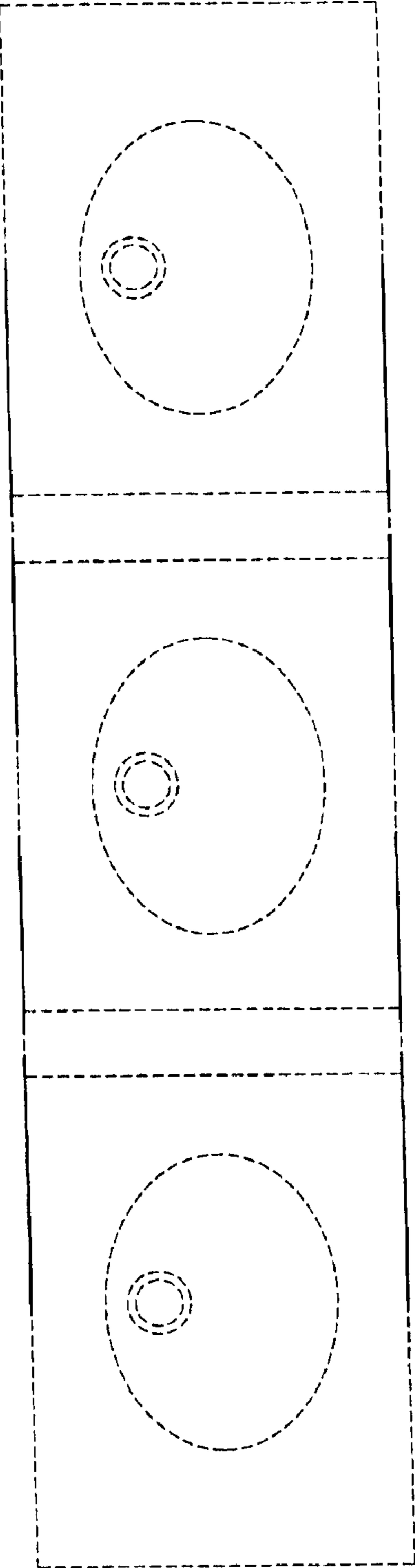

FIG. 2

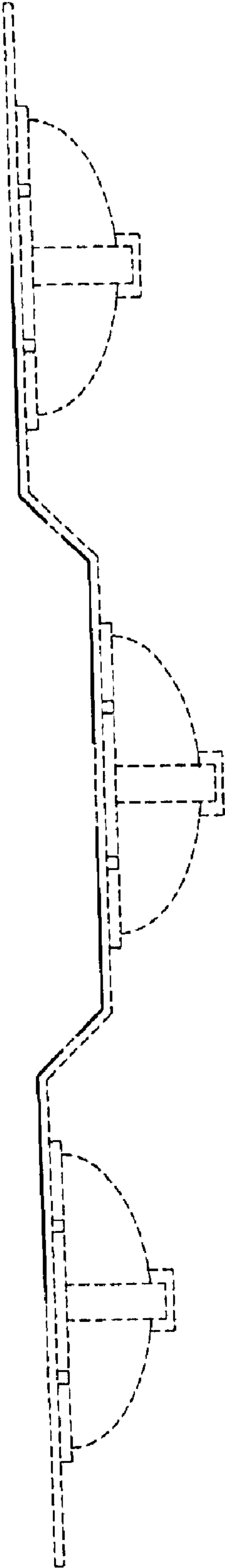

FIG. 3

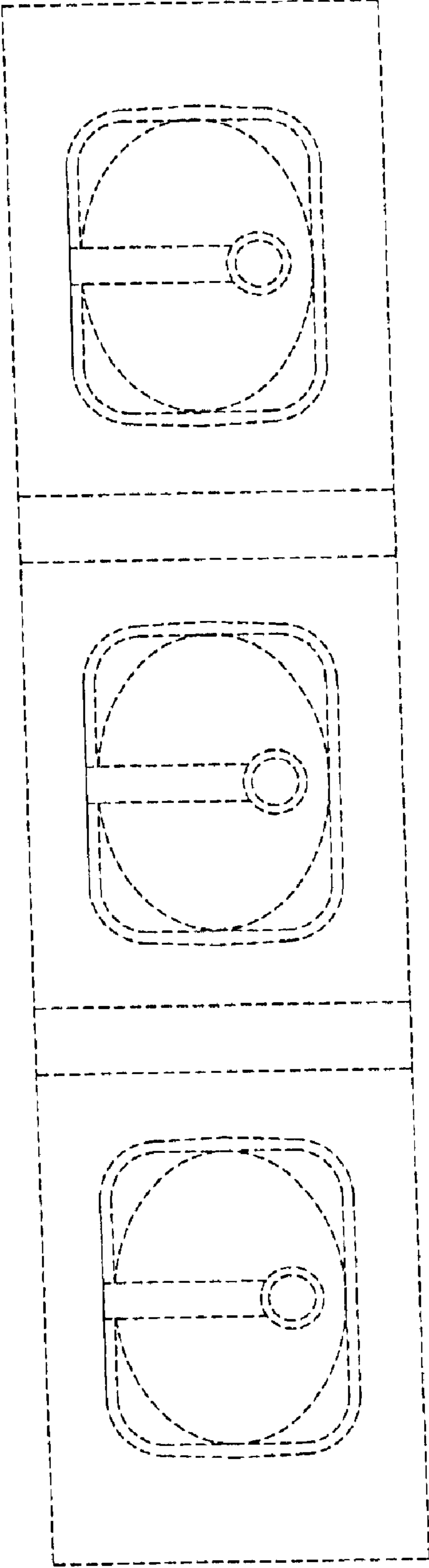

FIG. 4

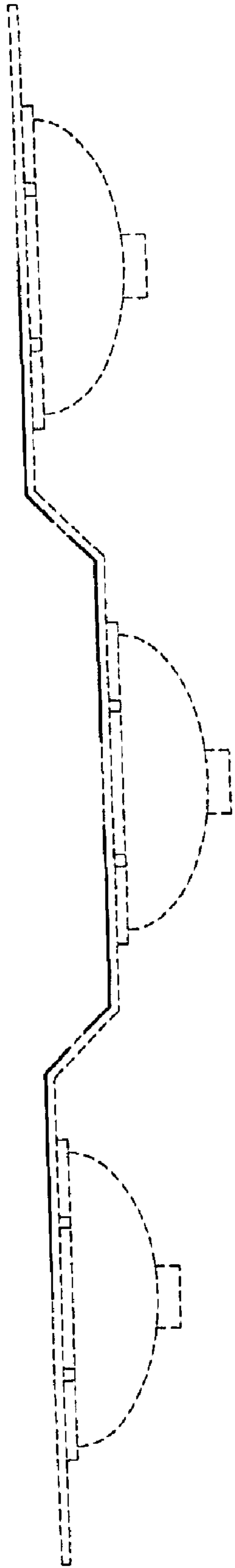

FIG. 5

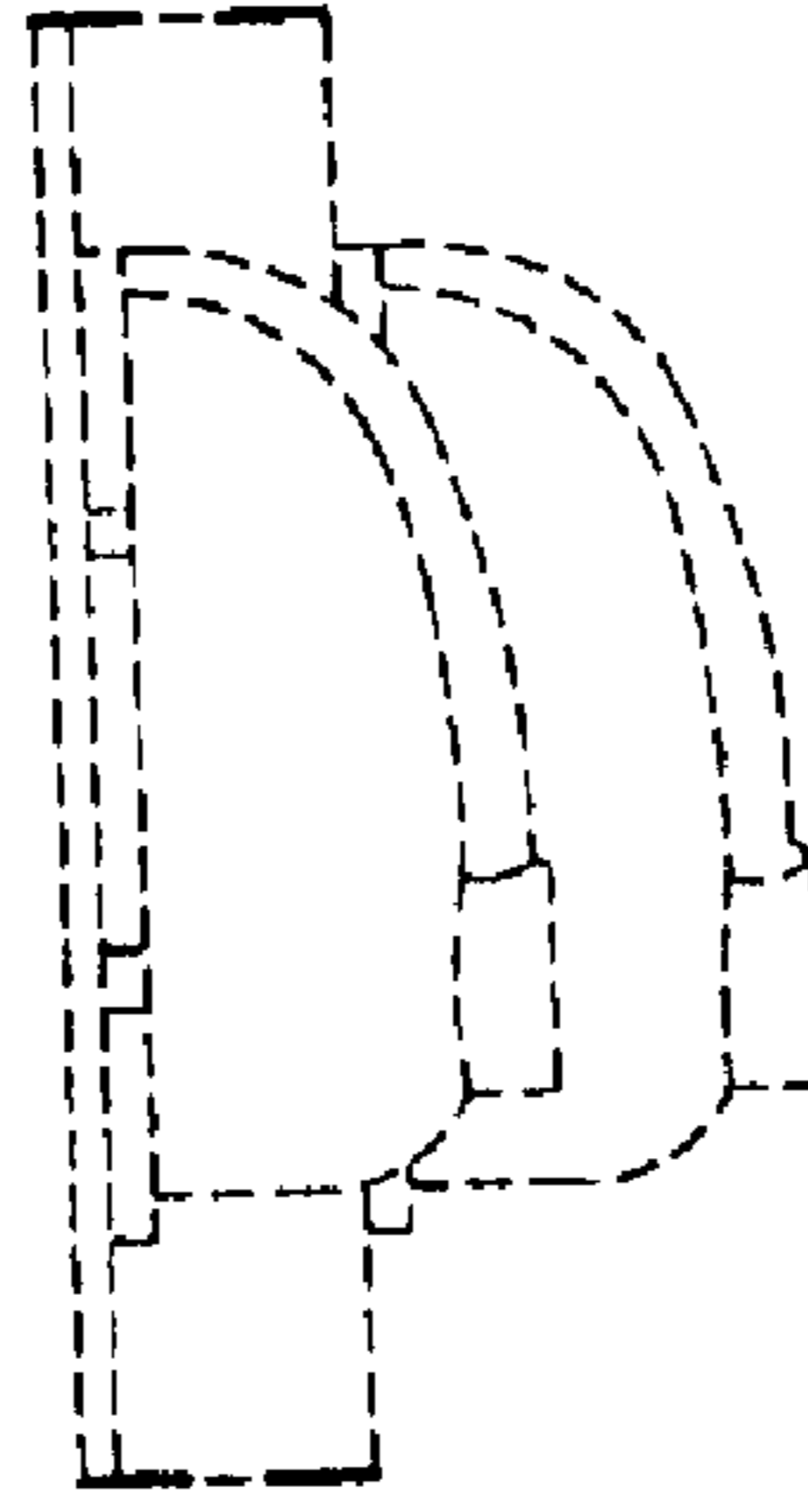

FIG. 7

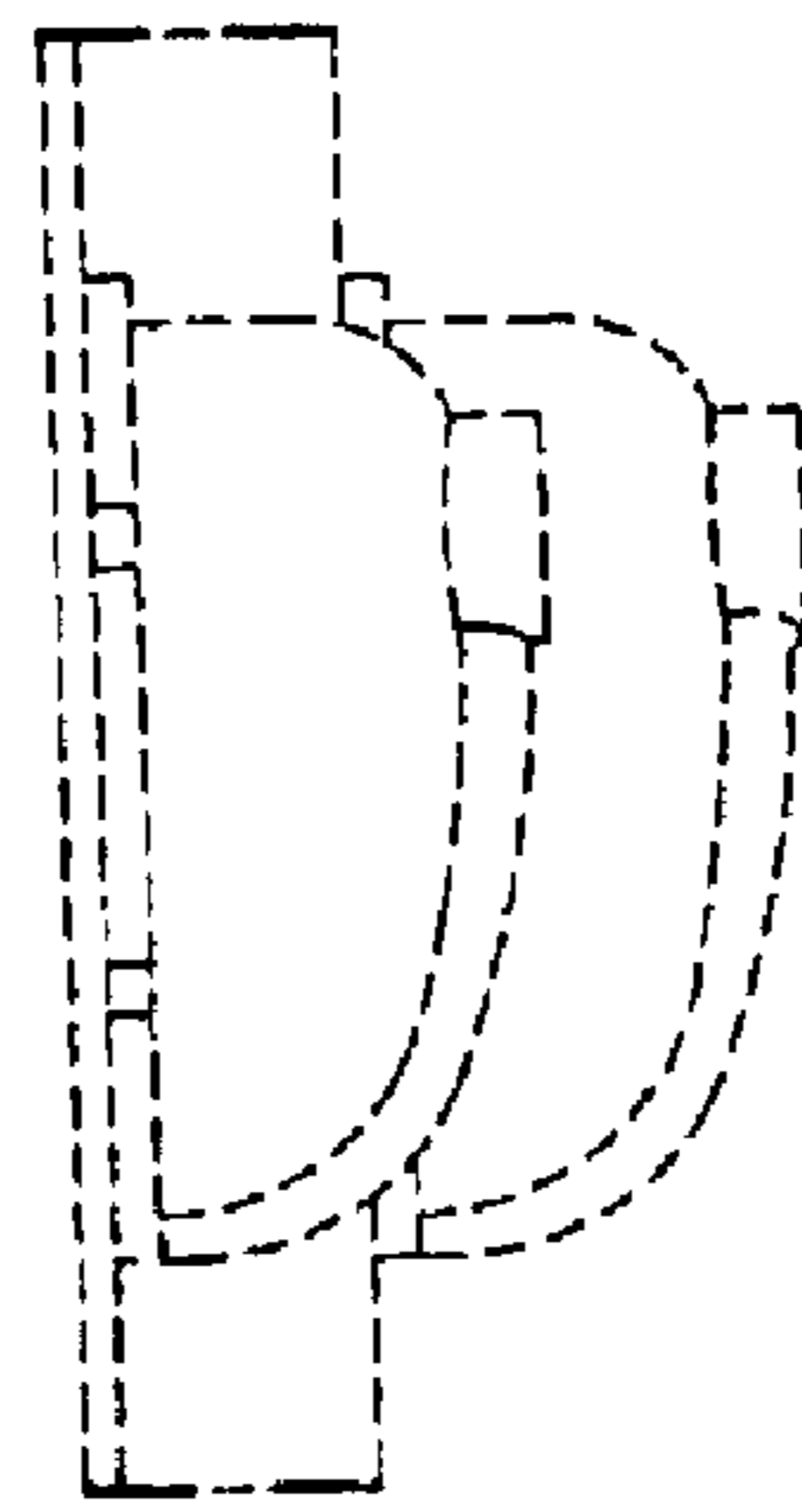

FIG. 6

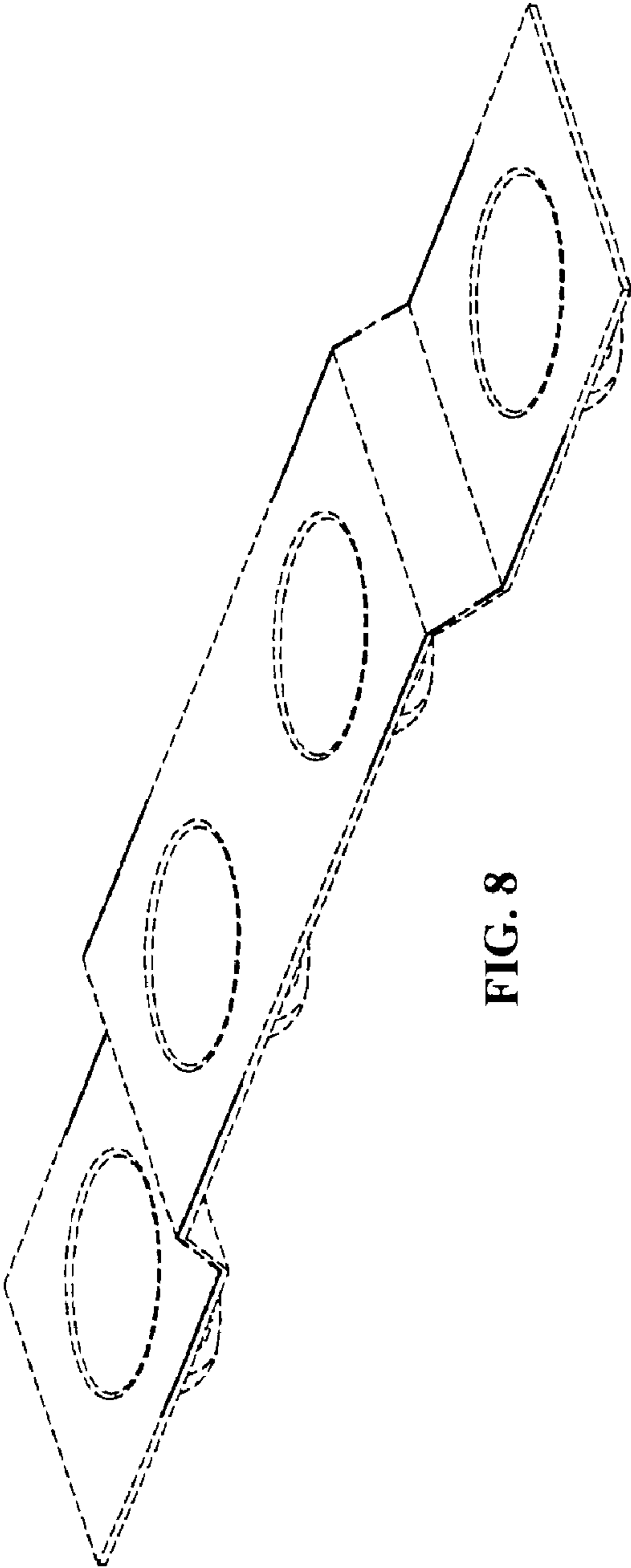

FIG. 8

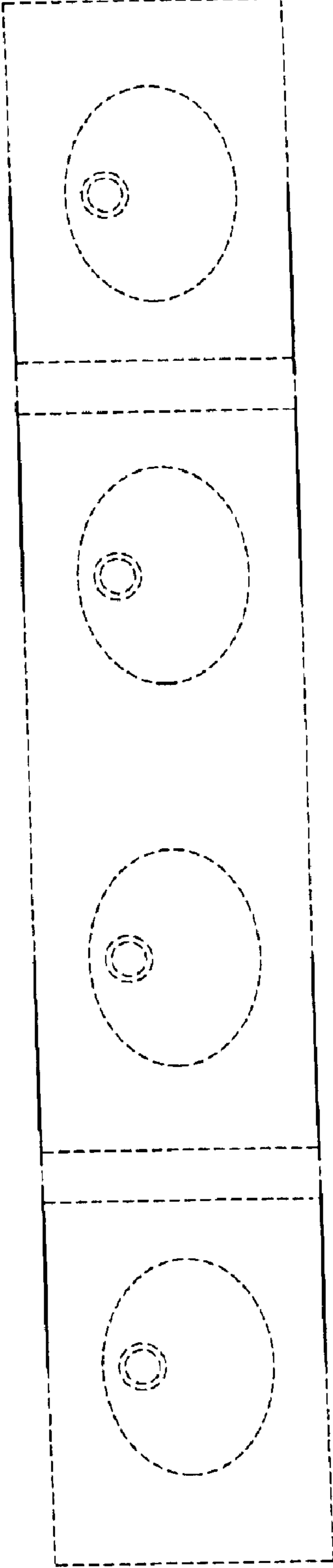

FIG. 9

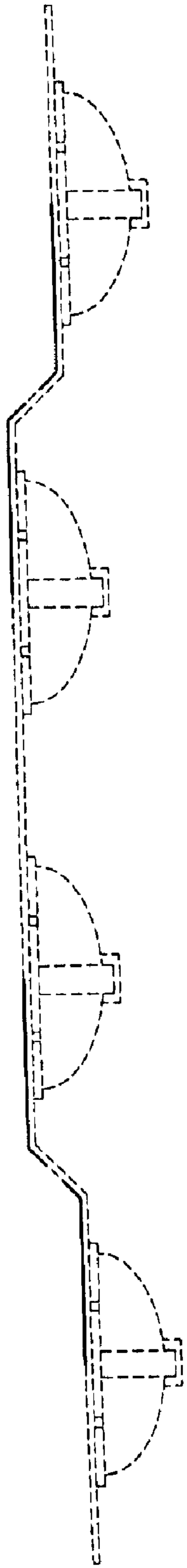

FIG. 10

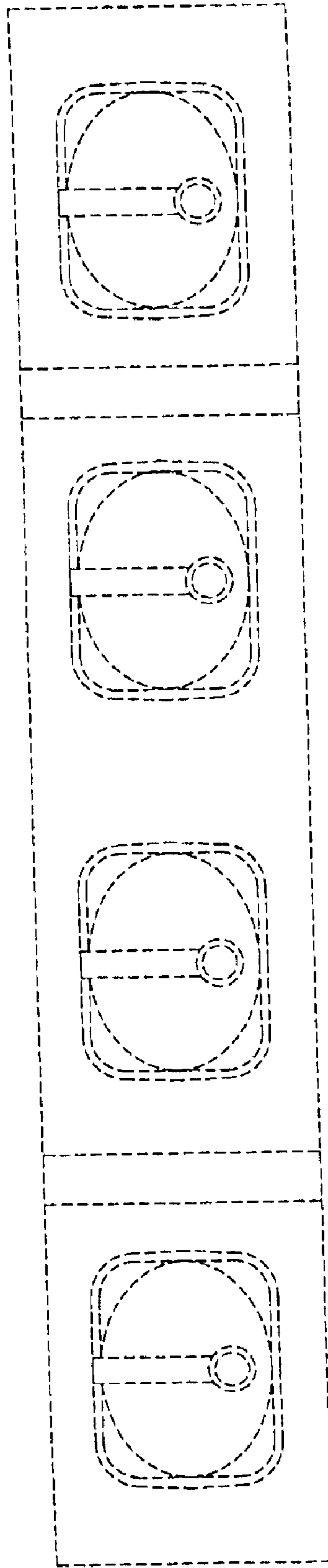

FIG. 11

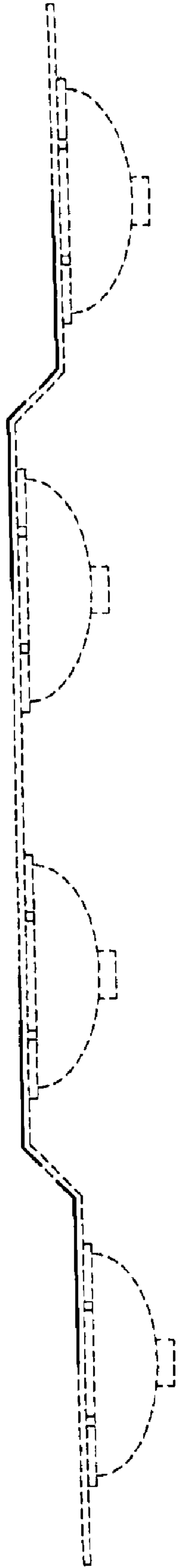

FIG. 12

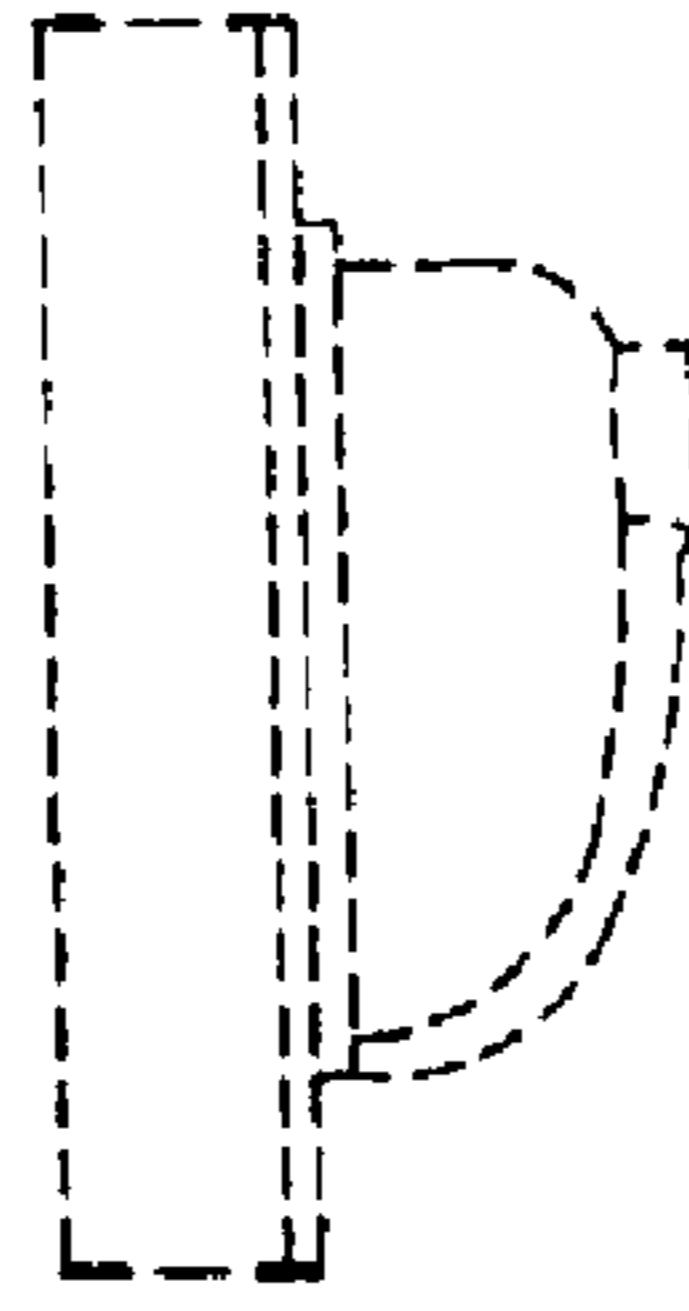

FIG. 14

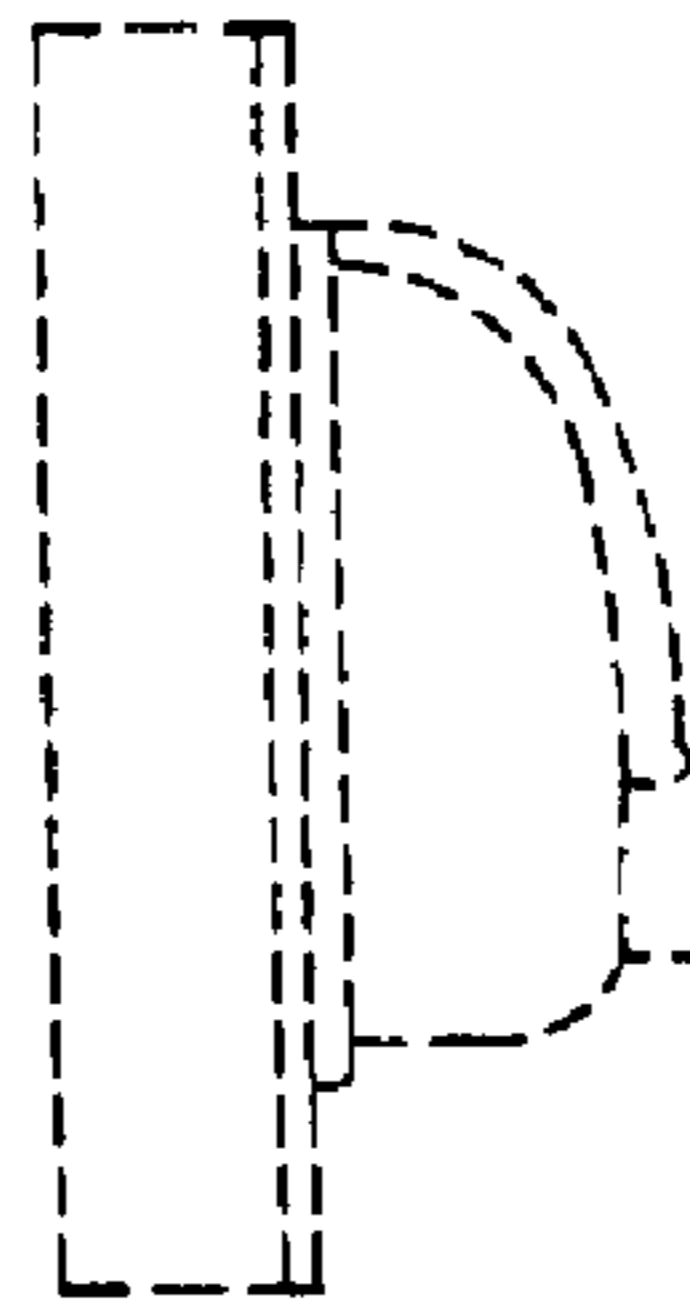

FIG. 13