

US00D509497S

(12) **United States Design Patent**
Michler

(10) **Patent No.:** **US D509,497 S**

(45) **Date of Patent:** **** Sep. 13, 2005**

(54) **MOBILE PHONE**

(75) **Inventor:** **Nico Michler, München (DE)**

(73) **Assignee:** **Siemens Aktiengesellschaft, Munich (DE)**

(**) **Term:** **14 Years**

(21) **Appl. No.:** **29/212,089**

(22) **Filed:** **Aug. 26, 2004**

(30) **Foreign Application Priority Data**

Feb. 27, 2004 (EM) 000149802

(51) **LOC (8) Cl.** **14-03**

(52) **U.S. Cl.** **D14/138**

(58) **Field of Search** D14/137, 138,
D14/147-148, 247-248, 144, 341-347;
379/433.01-433.13, 434; 455/550.1-90.3,
575.4, 566, 575.1, 556.1, 556.2, 575.6;
D21/517; 345/169

(56) **References Cited**

U.S. PATENT DOCUMENTS

D406,131 S	*	2/1999	Osthues	D14/138
6,308,084 B1	*	10/2001	Lonka	455/556.1
D466,096 S	*	11/2002	Takada	D14/138
D469,367 S	*	1/2003	Mirabelli et al.	D10/65
D476,328 S	*	6/2003	Miao et al.	D14/346
D477,596 S	*	7/2003	Hayes	D14/343
D479,215 S	*	9/2003	Yokoyama	D14/138
D481,692 S	*	11/2003	Husgafvel	D14/138
D485,267 S	*	1/2004	Chien	D14/346
D492,276 S	*	6/2004	Walliser et al.	D14/138
D493,156 S	*	7/2004	Hamann et al.	D14/138
D494,561 S	*	8/2004	Kagami et al.	D14/138
D494,950 S	*	8/2004	Keunecke	D14/138
D495,310 S	*	8/2004	Husgafvel	D14/138
D496,921 S	*	10/2004	Hwang	D14/138
D498,737 S	*	11/2004	Park et al.	D14/138

D498,754 S	*	11/2004	Blyth	D14/341
6,822,871 B2	*	11/2004	Lee et al.	361/727
D501,475 S	*	2/2005	Kim	D14/346
D502,162 S	*	2/2005	Kim et al.	D14/138
2003/0064688 A1	*	4/2003	Mizuta et al.	455/90
2004/0259592 A1	*	12/2004	Taneya et al.	455/556.1
2004/0266477 A1	*	12/2004	Murata	455/556.1
2005/0009581 A1	*	1/2005	Im et al.	455/575.4
2005/0014538 A1	*	1/2005	Hyun et al.	455/575.4

FOREIGN PATENT DOCUMENTS

JP	1088577	*	10/2000	
JP	1124434	*	10/2001	
JP	1160810	*	12/2002	
JP	2003298699 A	*	10/2003 H04M/1/02

OTHER PUBLICATIONS

NTTDoCoMo SO505i, © 2003, showings from NTT DoCoMo visited Apr. 10, 2003 and www.mobileburn.com visited Sep. 28, 2004.*

* cited by examiner

Primary Examiner—Jeffrey Asch

(74) *Attorney, Agent, or Firm*—Bell Boyd & Lloyd LLC

(57) **CLAIM**

I claim the ornamental design for a mobile phone, as shown and described.

DESCRIPTION

FIG. 1 is a front elevational view of a mobile phone of the claimed design.

FIG. 2 is a rear elevational view of the mobile phone of FIG. 1.

FIG. 3 is a top view of the mobile phone of FIG. 1.

FIG. 4 is a bottom view of the mobile phone of FIG. 1.

FIG. 5 is a right side view of the mobile phone of FIG. 1.

FIG. 6 is a left side view of the mobile phone of FIG. 1; and,

FIG. 7 is a perspective view of the mobile phone of FIG. 1.

1 Claim, 7 Drawing Sheets

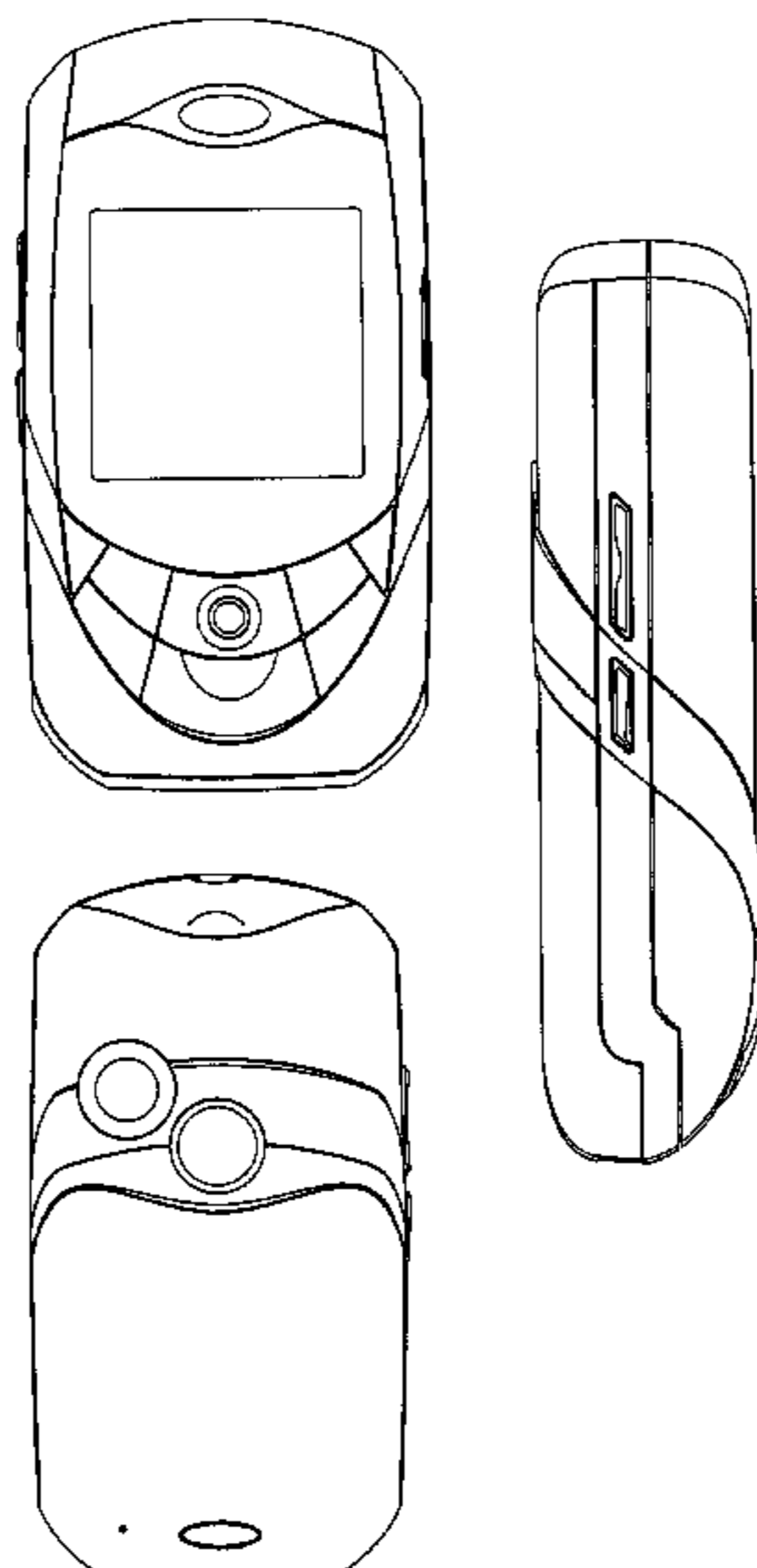

Fig. 1

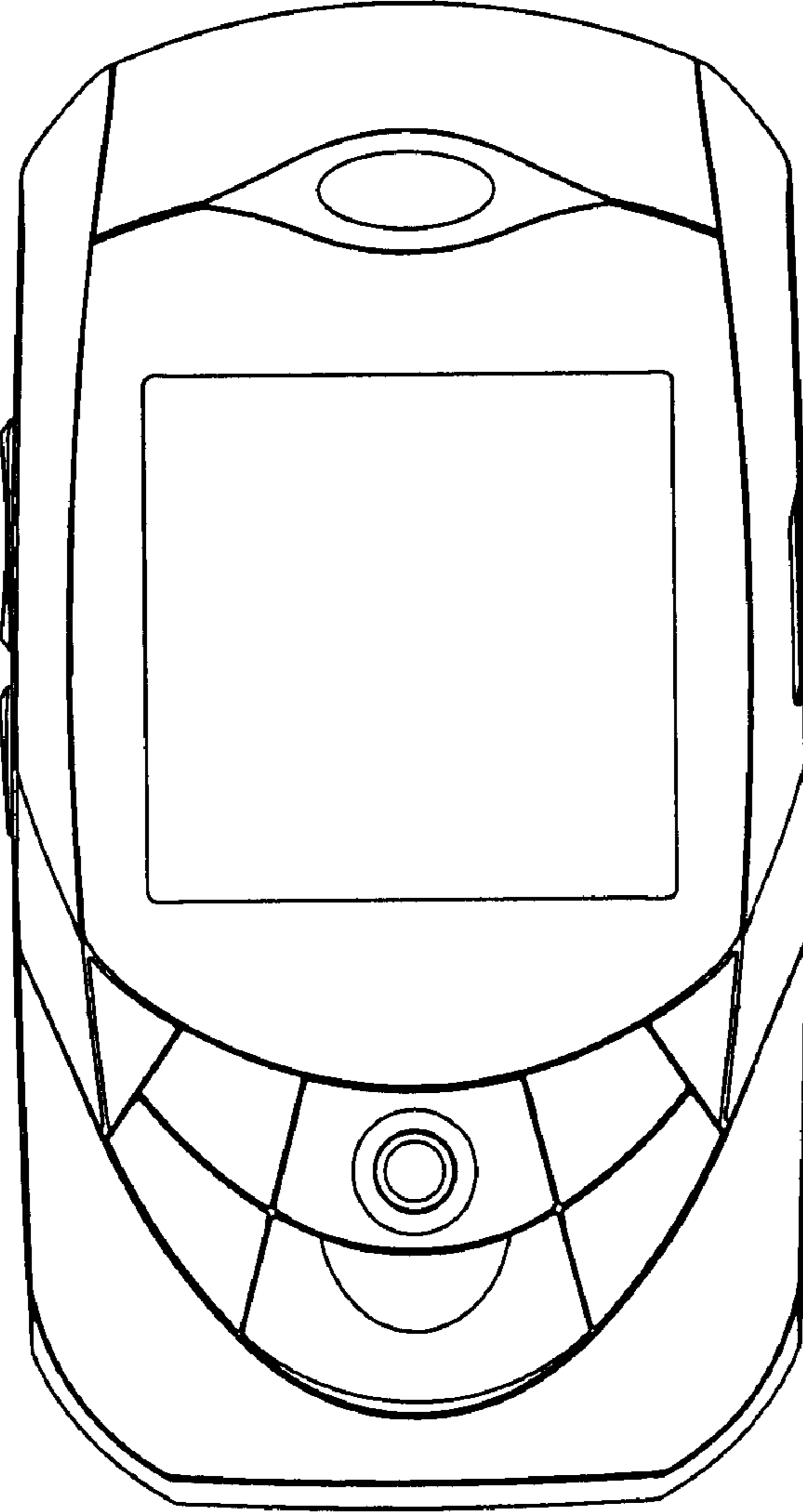

Fig. 2

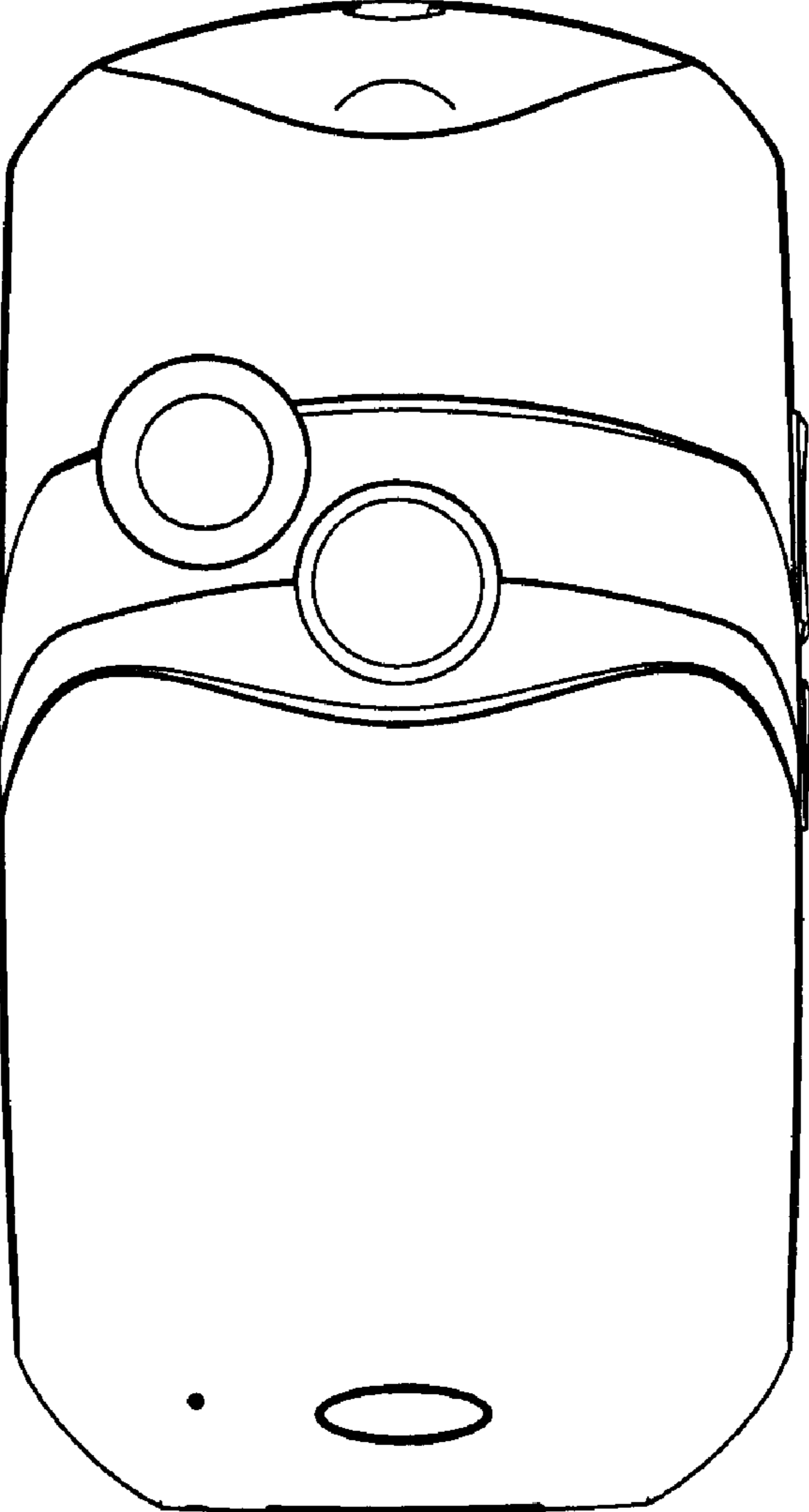

Fig. 3

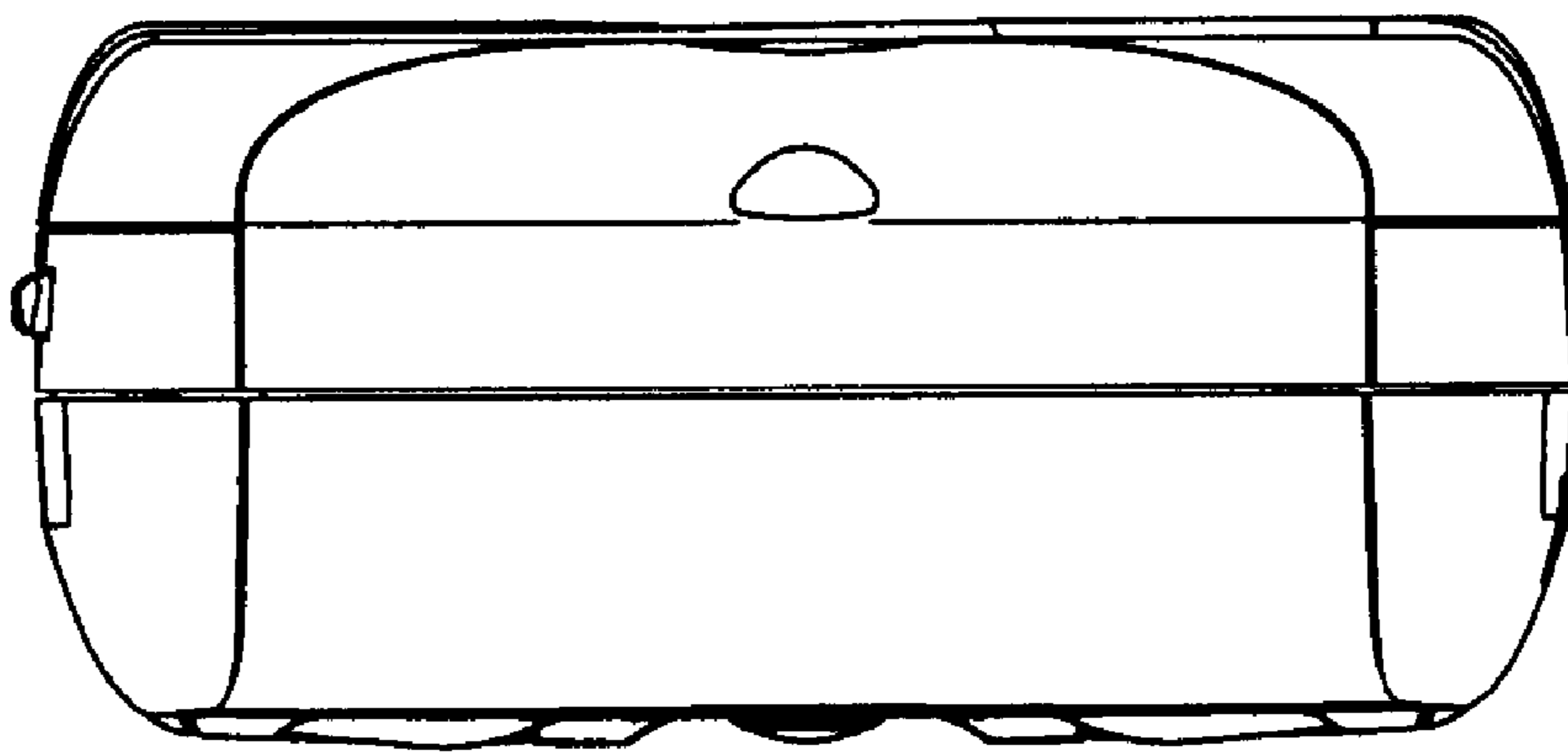

Fig. 4

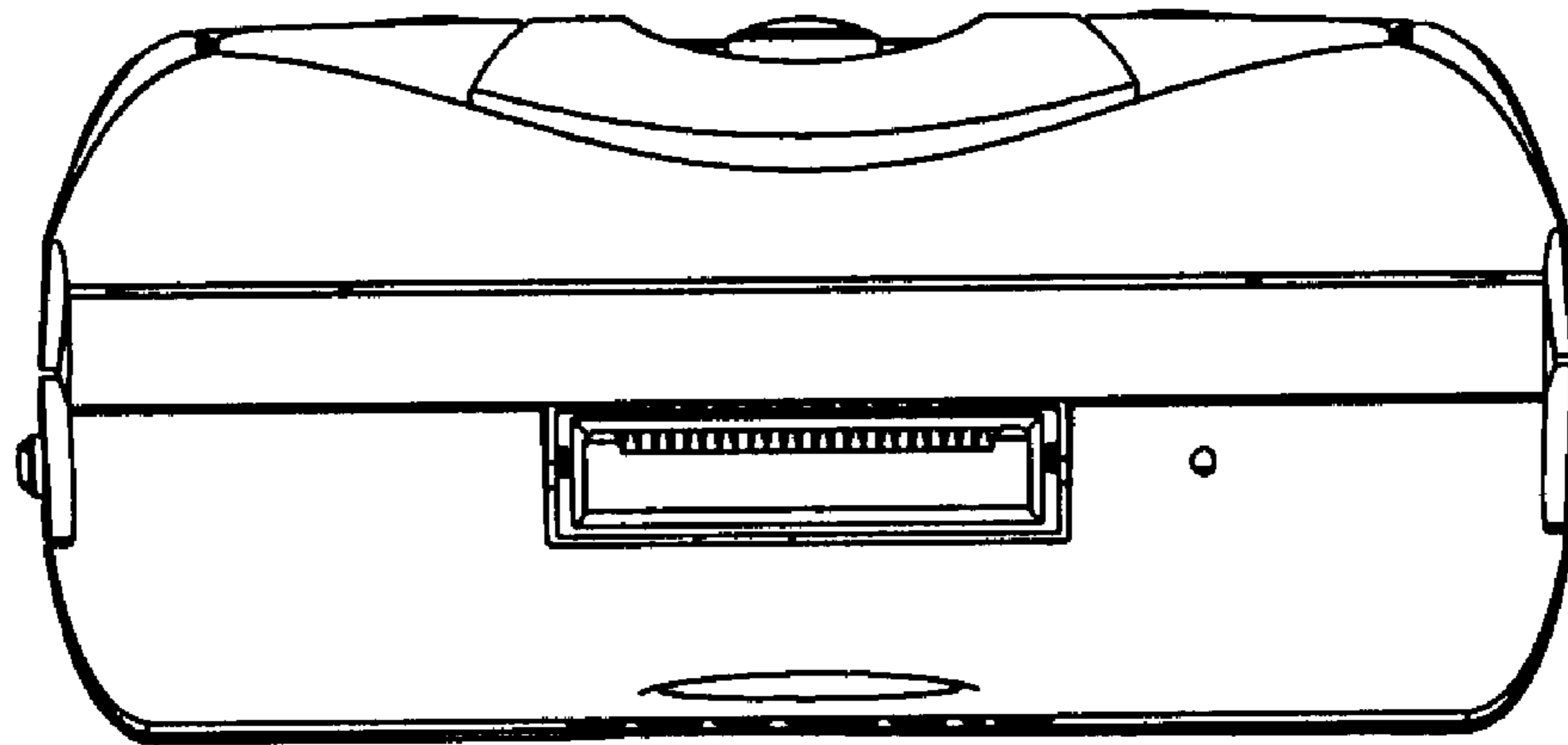

Fig. 5

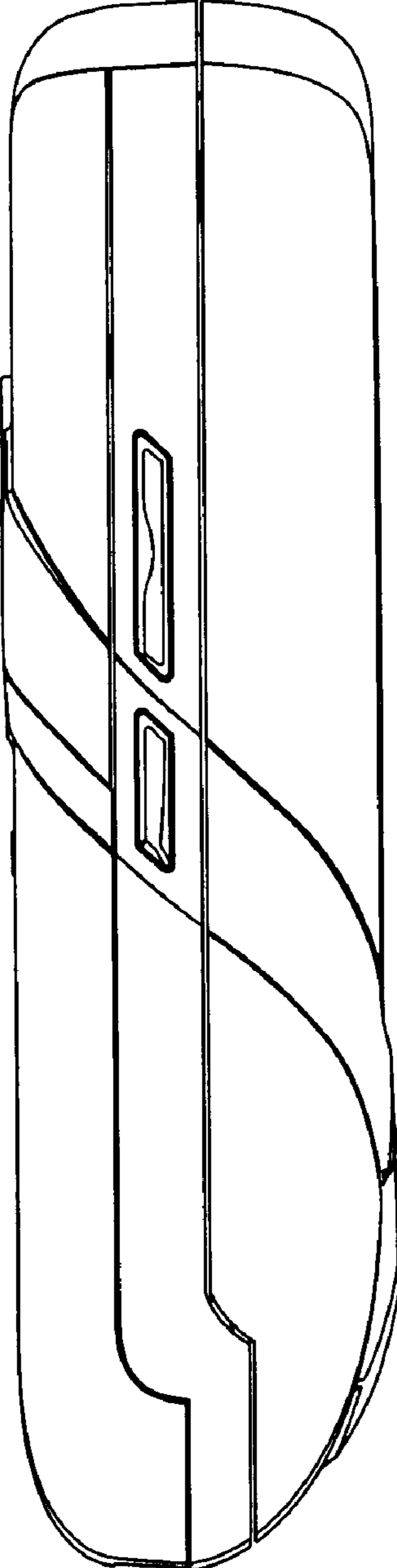

Fig. 6

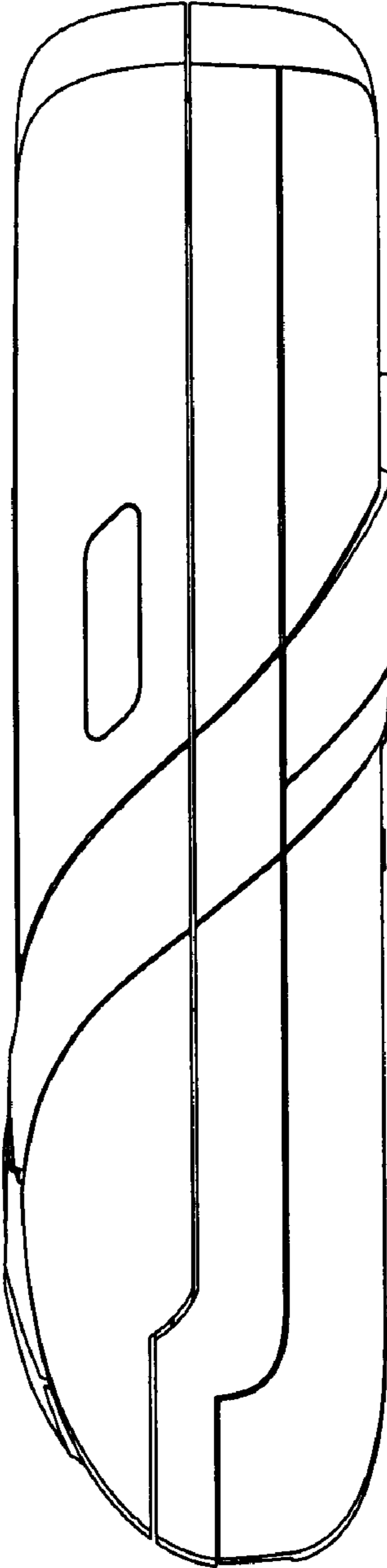

Fig. 7

