

US00D509421S

(12) **United States Design Patent**
Gehry

(10) **Patent No.:** **US D509,421 S**

(45) **Date of Patent:** **** Sep. 13, 2005**

(54) **HANDLE**

(75) **Inventor:** **Frank O. Gehry**, Los Angeles, CA
(US)

(73) **Assignee:** **Gehry Designs, LLC**, Los Angeles, CA
(US)

(**) **Term:** **14 Years**

(21) **Appl. No.:** **29/214,631**

(22) **Filed:** **Oct. 7, 2004**

(30) **Foreign Application Priority Data**

Apr. 8, 2004 (IT) MI2004 O 000084

(51) **LOC (8) Cl.** **08-06**

(52) **U.S. Cl.** **D8/300**

(58) **Field of Search** D8/DIG. 9, DIG. 10,
D8/107, 300-309, 315, 321, 350, 393;
D23/250-252, 254; 16/110.1, 412-415,
417, 430; 292/DIG. 30, 336.3, 347

(56) **References Cited**

U.S. PATENT DOCUMENTS

- 3,107,113 A * 10/1963 Sconzo 292/228
- D197,400 S * 1/1964 Patriquin D8/302
- D231,725 S * 6/1974 Frattini D8/308
- D395,220 S * 6/1998 Klinker D8/308
- D443,921 S * 6/2001 Tolosa D23/252
- D457,048 S * 5/2002 Zoerner et al. D8/308
- D460,529 S * 7/2002 Caplow D23/252
- D464,119 S * 10/2002 Blomstrom D23/252

- D466,771 S * 12/2002 Chang D8/41
- D470,574 S * 2/2003 Marshall D23/252
- D470,922 S * 2/2003 Marshall D23/254
- D476,398 S * 6/2003 Ouyoung D23/252
- D491,042 S * 6/2004 Ellis D8/337

OTHER PUBLICATIONS

www.southco.com—online catalog, p. 1 of swing door lock category, Mobella Products, no item number, Mar. 1, 2005.*
Kitchen & Bath Source Book, Valli & Colombo, c. 1989 advertisement, p. A027, 1 page.*

* cited by examiner

Primary Examiner—Stella Reid
Assistant Examiner—Jean E. McCormick
(74) *Attorney, Agent, or Firm*—Young & Thompson

(57) **CLAIM**

I claim the ornamental design for a handle, as shown and described.

DESCRIPTION

FIG. 1 is a perspective view of the handle showing my new design;
FIG. 2 is a top view thereof;
FIG. 3 is a left side view thereof;
FIG. 4 is a right side view thereof;
FIG. 5 is a front view thereof;
FIG. 6 is a bottom view thereof; and,
FIG. 7 is a rear view thereof.

1 Claim, 2 Drawing Sheets

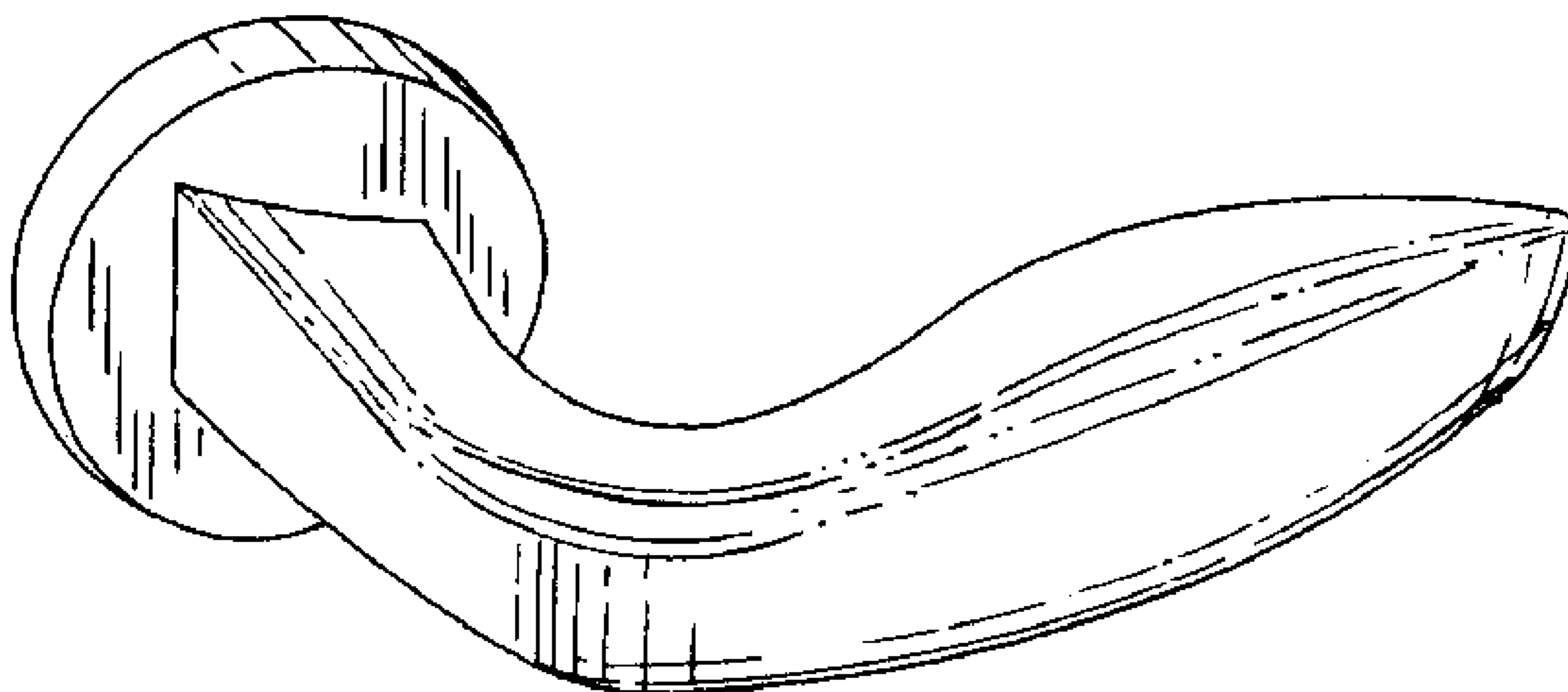

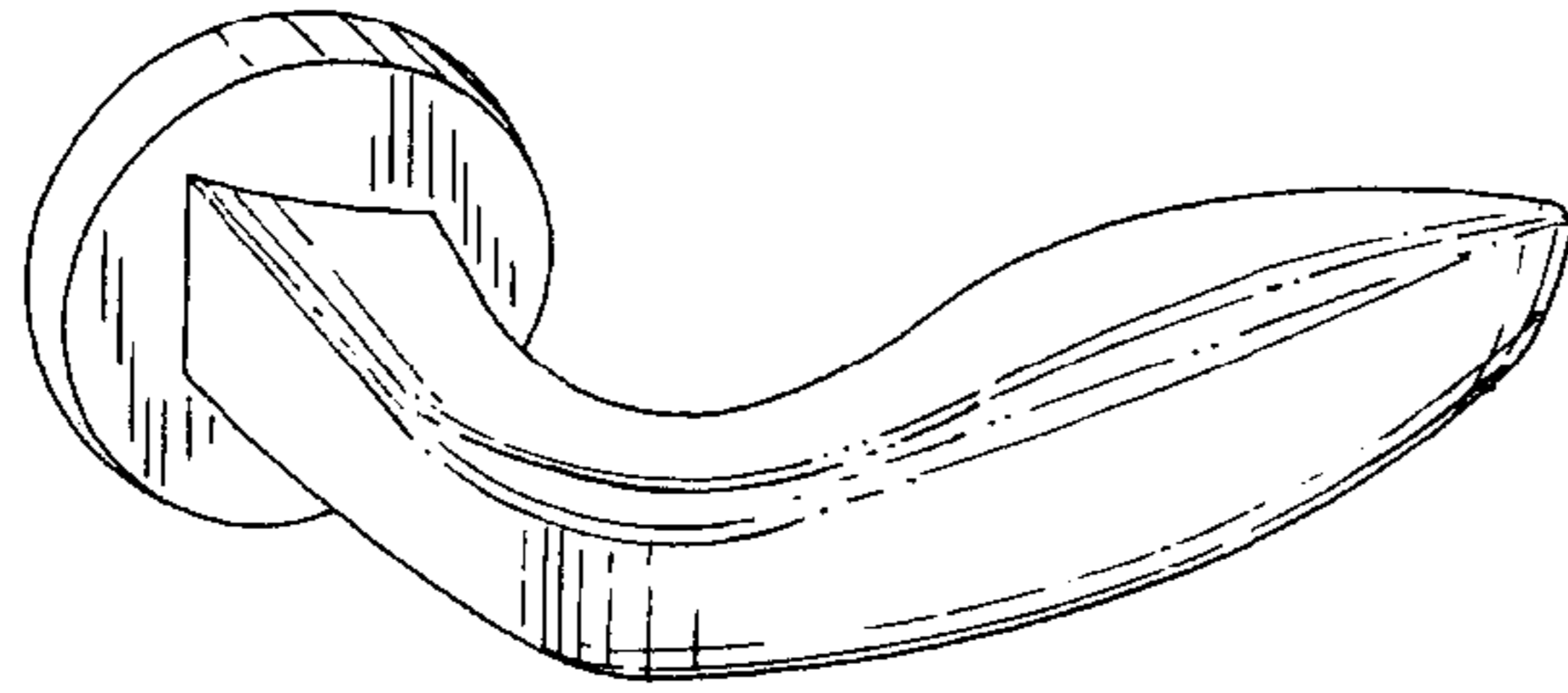

FIG. 1

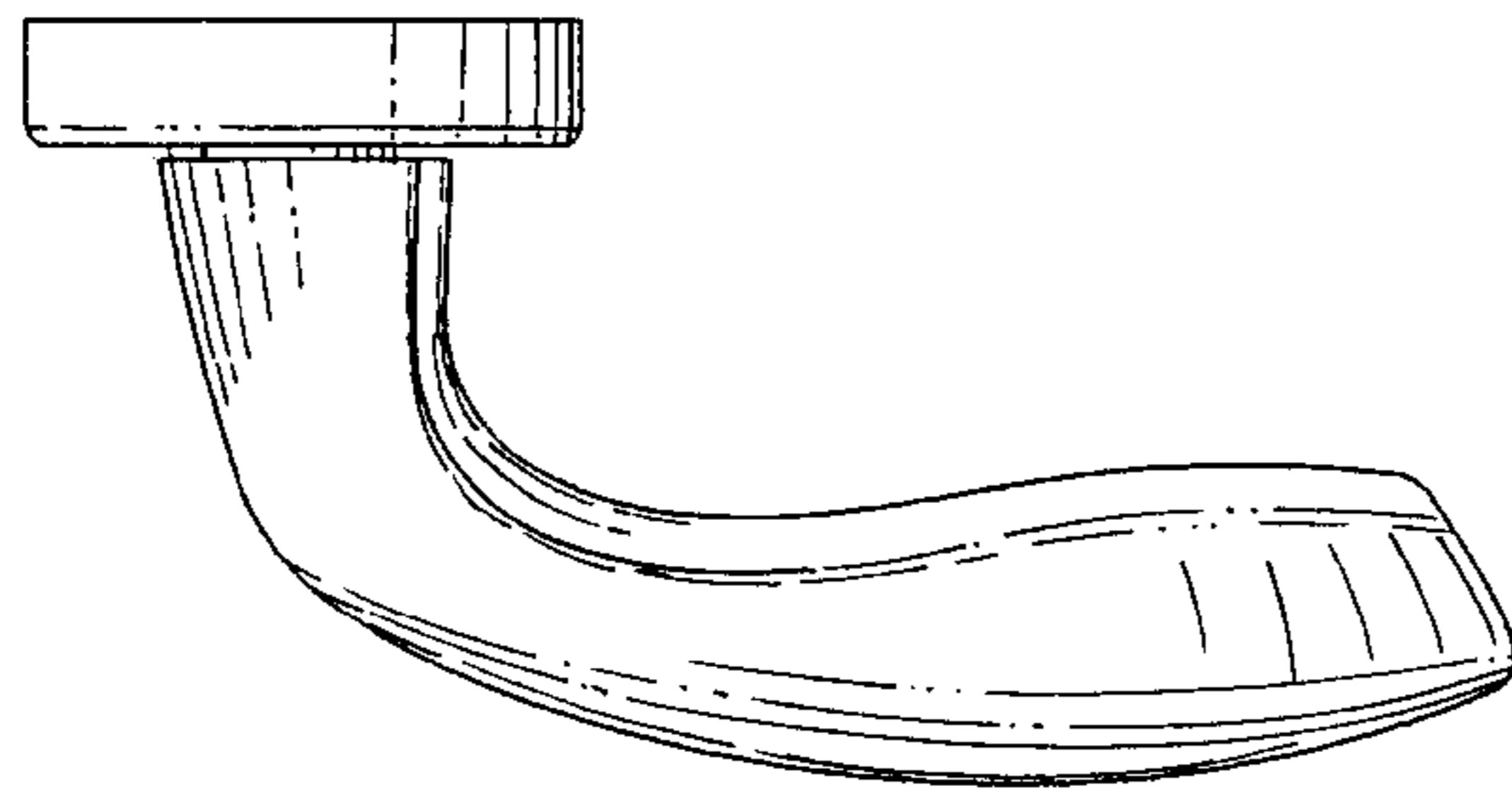

FIG. 2

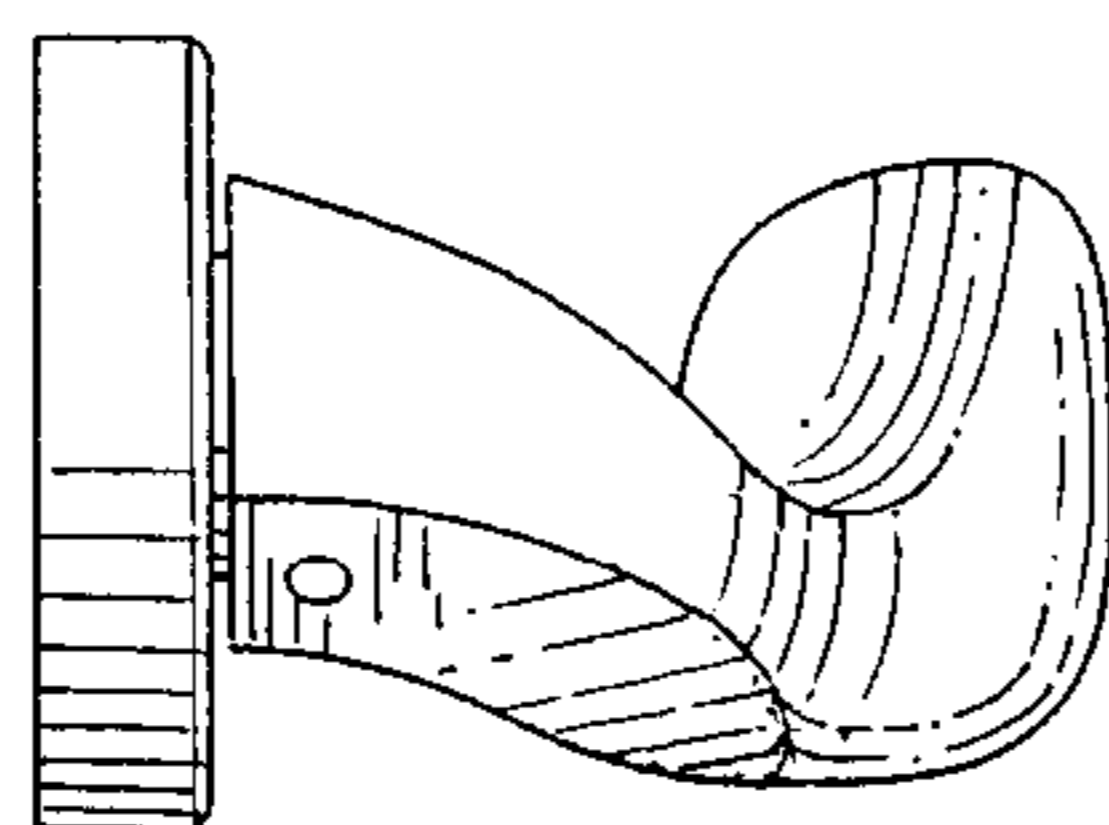

FIG. 3

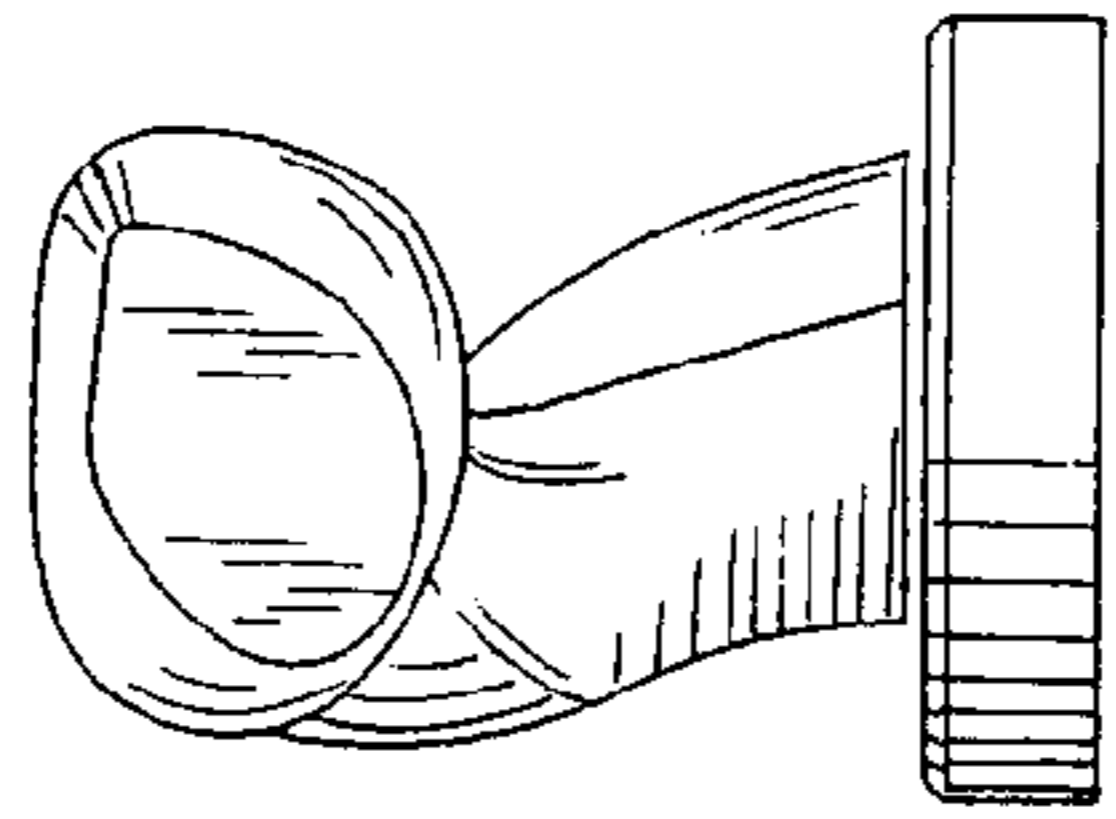

FIG. 4

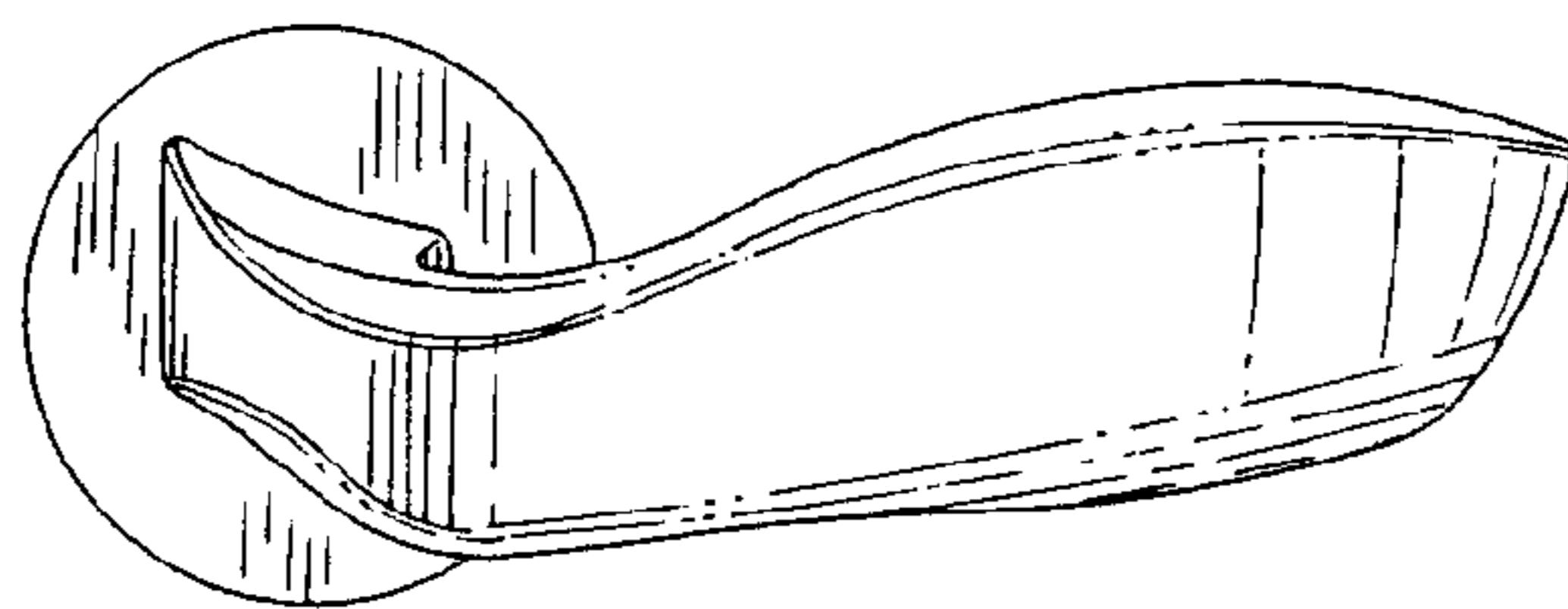

FIG. 5

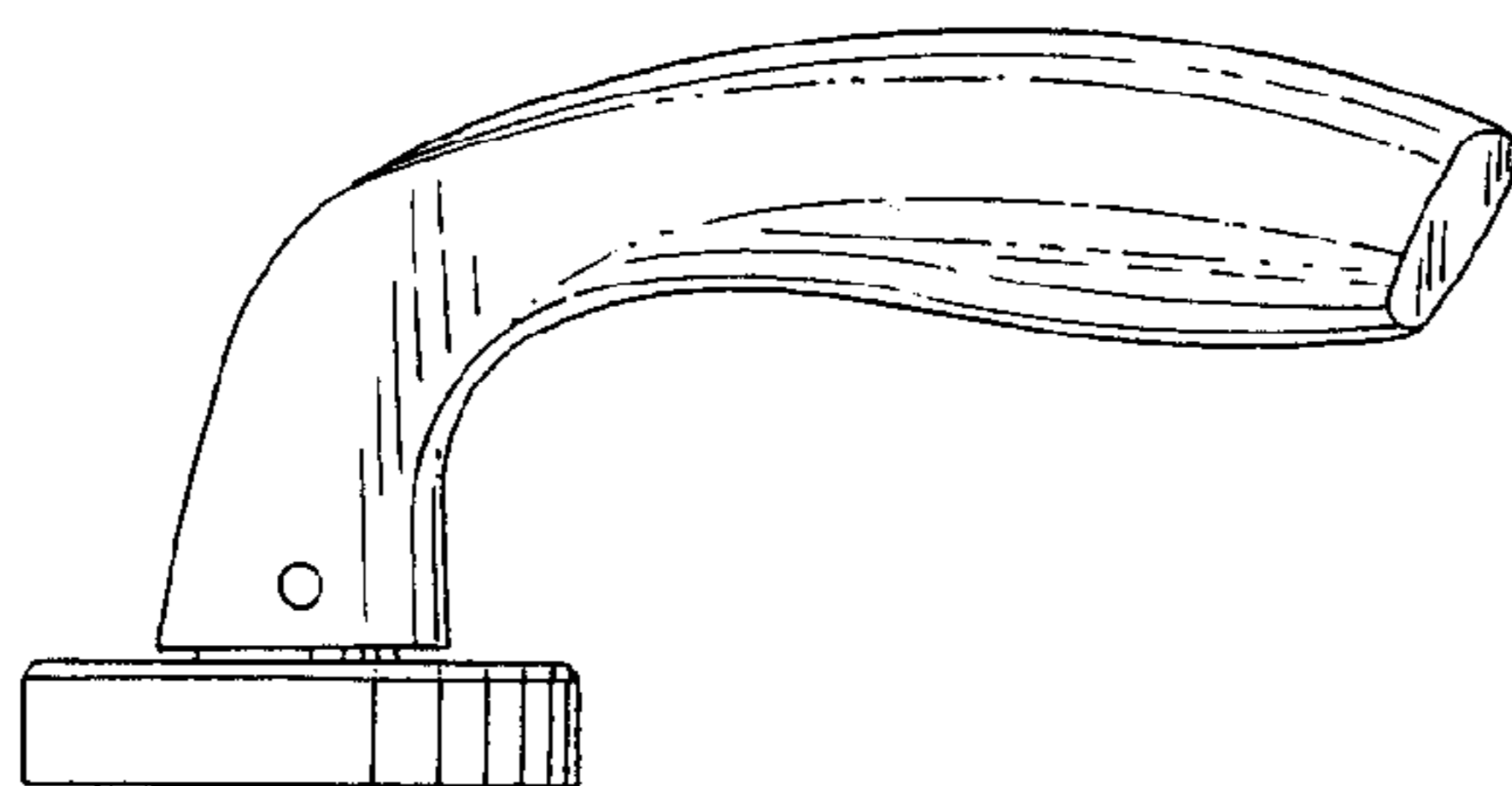

FIG. 6

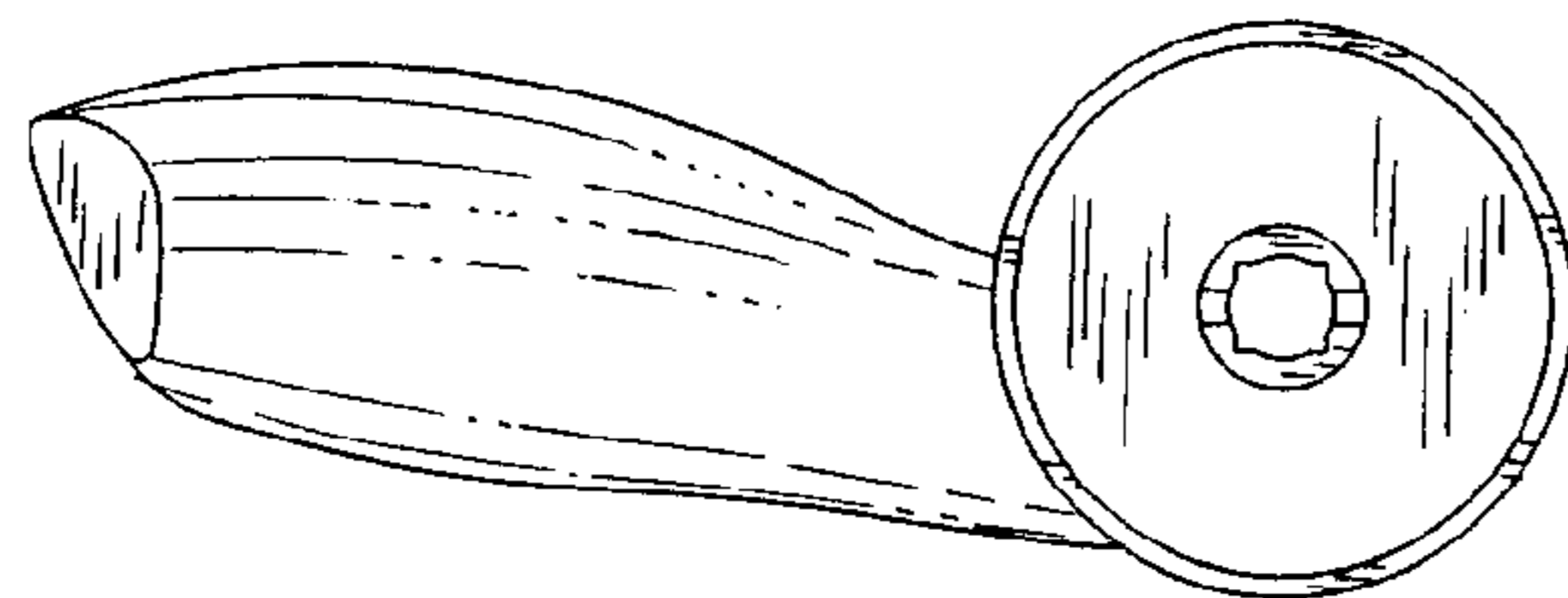

FIG. 7