

US00D509411S

(12) **United States Design Patent** (10) **Patent No.:** **US D509,411 S**
Laib et al. (45) **Date of Patent:** **** Sep. 13, 2005**

(54) **CONTAINER WITH COVER**

(75) Inventors: **Douglas M. Laib**, Orlando, FL (US);
John-Michael R. Ekeblad, Orlando, FL (US)

(73) Assignee: **Dart Industries Inc.**, Orlando, FL (US)

(**) Term: **14 Years**

(21) Appl. No.: **29/204,505**

(22) Filed: **Apr. 29, 2004**

Related U.S. Application Data

(63) Continuation of application No. 29/186,642, filed on Feb. 18, 2003, now abandoned.

(51) **LOC (8) Cl.** **07-01**

(52) **U.S. Cl.** **D7/629**

(58) **Field of Search** D7/629, 538-542,
D7/602; D3/201, 203, 206, 273, 274; D9/430-432,
424, 425; 220/675, 780-783, 792-799,
805

(56) **References Cited**

U.S. PATENT DOCUMENTS

4,697,703 A	10/1987	Will	
4,742,585 A	5/1988	Logsdon	
D302,774 S	* 8/1989	Murphy D7/629
4,989,731 A	2/1991	Shuert	
5,007,231 A	4/1991	Ingemann	

(Continued)

FOREIGN PATENT DOCUMENTS

JP	D1153951	8/2002
JP	D1153952	8/2002
JP	D1153953	8/2002
JP	D1153954	8/2002

OTHER PUBLICATIONS

Tupperware Collection Catalog, Sep. 2002, pp. 36 and 37 showing above listed Japanese Design Registrations 1153951; 1153952; 1153953; 1153954.

Primary Examiner—Terry A. Wallace

(74) *Attorney, Agent, or Firm*—John A. Doninger

(57) **CLAIM**

The ornamental design for a container with cover, as shown and described.

DESCRIPTION

FIG. 1 is a top, side and front perspective view of a first embodiment of a container with cover showing the new design;

FIG. 2 is a front elevation view thereof;

FIG. 3 is a rear elevation view thereof;

FIG. 4 is a left side elevation view thereof, the right side elevation view being a mirror image thereof;

FIG. 5 is a top plan view thereof;

FIG. 6 is a bottom plan view thereof.

FIG. 7 is a top, side and front perspective view of a second embodiment of a container with cover showing the new design;

FIG. 8 is a front elevation view thereof;

FIG. 9 is a rear elevation view thereof;

FIG. 10 is a left side elevation view thereof, the right side elevation being a mirror image thereof;

FIG. 11 is a top plan view thereof;

FIG. 12 is a bottom plan view thereof;

FIG. 13 is a top, side and front perspective view of a third embodiment of a container with cover showing the new design;

FIG. 14 is a front elevation view thereof;

FIG. 15 is a rear elevation view thereof;

FIG. 16 is a left side elevation view thereof, the right side elevation view being a mirror image thereof;

FIG. 17 is a top plan view thereof;

FIG. 18 is a bottom plan view thereof.

FIG. 19 is a top, side and front perspective view of a fourth embodiment of a container with cover showing the new design;

FIG. 20 is a front elevation view thereof;

FIG. 21 is a rear elevation view thereof;

FIG. 22 is a left side elevation view thereof, the right side elevation view being a mirror image thereof;

FIG. 23 is a top plan view thereof; and,

FIG. 24 is a bottom plan view thereof.

1 Claim, 13 Drawing Sheets

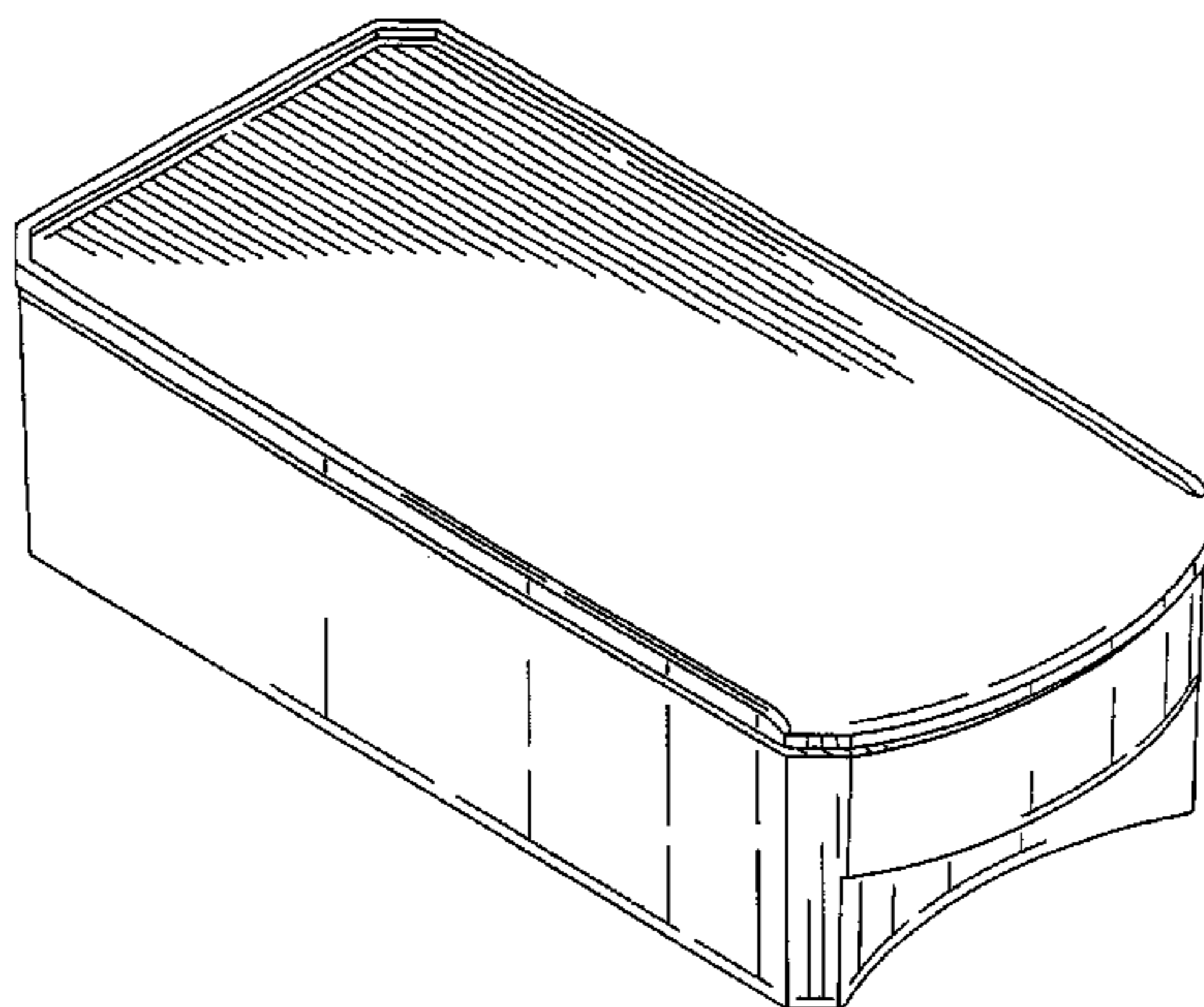

US D509,411 S

Page 2

U.S. PATENT DOCUMENTS

D330,161 S	*	10/1992	Schuh	D9/425	D413,231 S	8/1999	Loew et al.	D7/612	
D334,499 S		4/1993	Meisner et al.		5,944,211 A	8/1999	Woodnorth et al.	220/203.13	
5,363,978 A		11/1994	Molo		D418,021 S	12/1999	Terracciano et al.	D7/605	
5,377,858 A		1/1995	Morris		D422,457 S	4/2000	Daenen et al.	D7/615	
D366,397 S		1/1996	Zimmerman		D423,294 S	4/2000	Klein et al.	D7/605	
D371,053 S		6/1996	Lillelund et al.		D437,984 S	2/2001	Weiss et al.	D34/1	
5,535,940 A		7/1996	Olds		D445,568 S	*	7/2001	Lippisch	D3/273
D372,641 S	*	8/1996	Betend-Bon	D7/629	D445,986 S		7/2001	Stanek et al.	D34/38
D373,053 S		8/1996	Allegre		D448,662 S	*	10/2001	Collins et al.	D9/425
D387,530 S		12/1997	Doxey	D34/1	6,311,838 B1	11/2001	Johnson et al.	206/363	
5,697,707 A		12/1997	Esposito		6,318,586 B1	11/2001	Frankenberg	220/826	
5,762,228 A		6/1998	Morgan et al.	220/367.1	D455,614 S	4/2002	Miller	D7/629	
D397,552 S	*	9/1998	Rutledge	D3/302	6,371,363 B1	4/2002	Franklin et al.	229/109	
D398,485 S		9/1998	Landauer et al.	D7/629	D462,877 S	9/2002	Lillelund et al.	D7/602	
D405,576 S		2/1999	Rausch	D34/1					

* cited by examiner

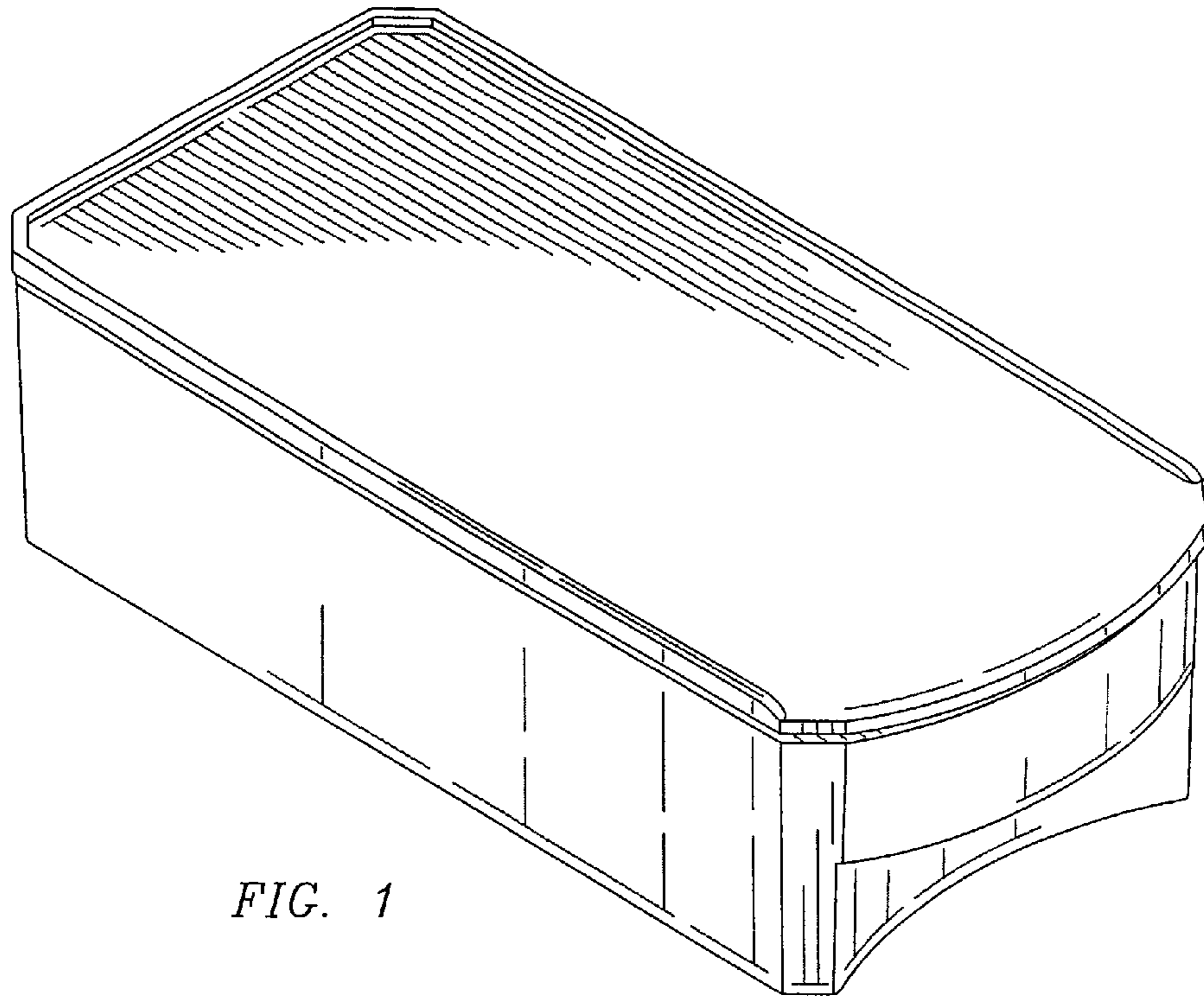

FIG. 1

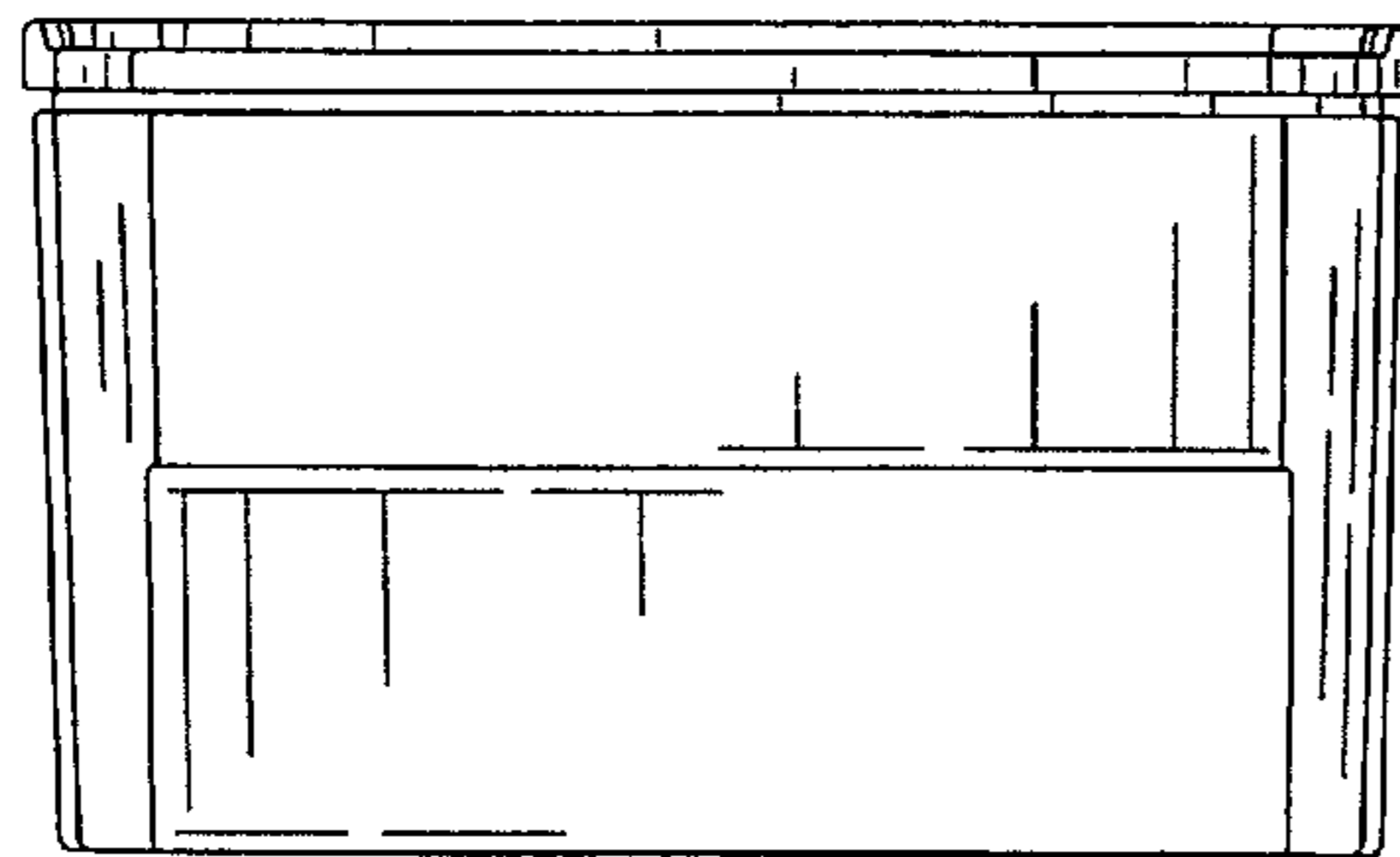

FIG. 2

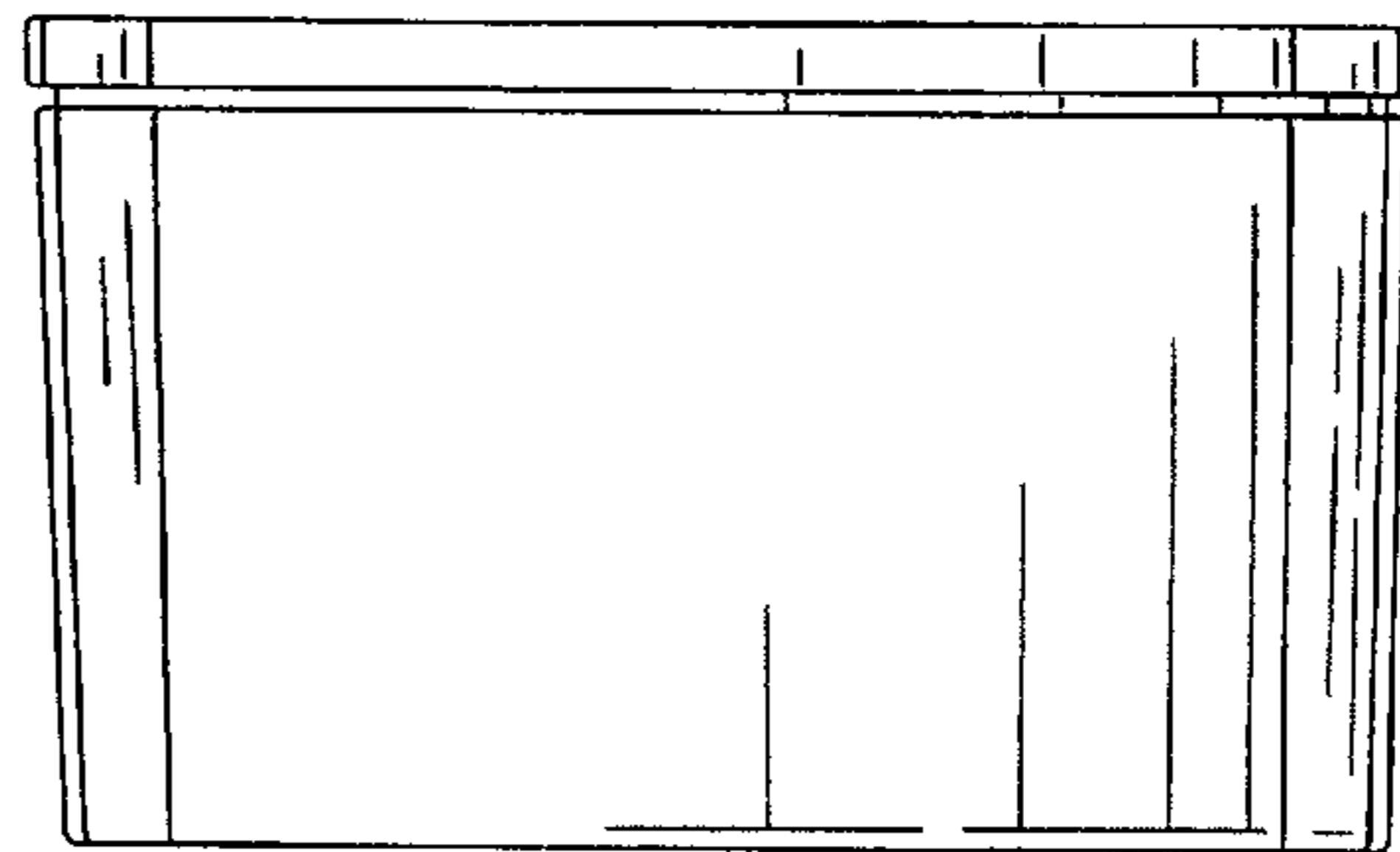

FIG. 3

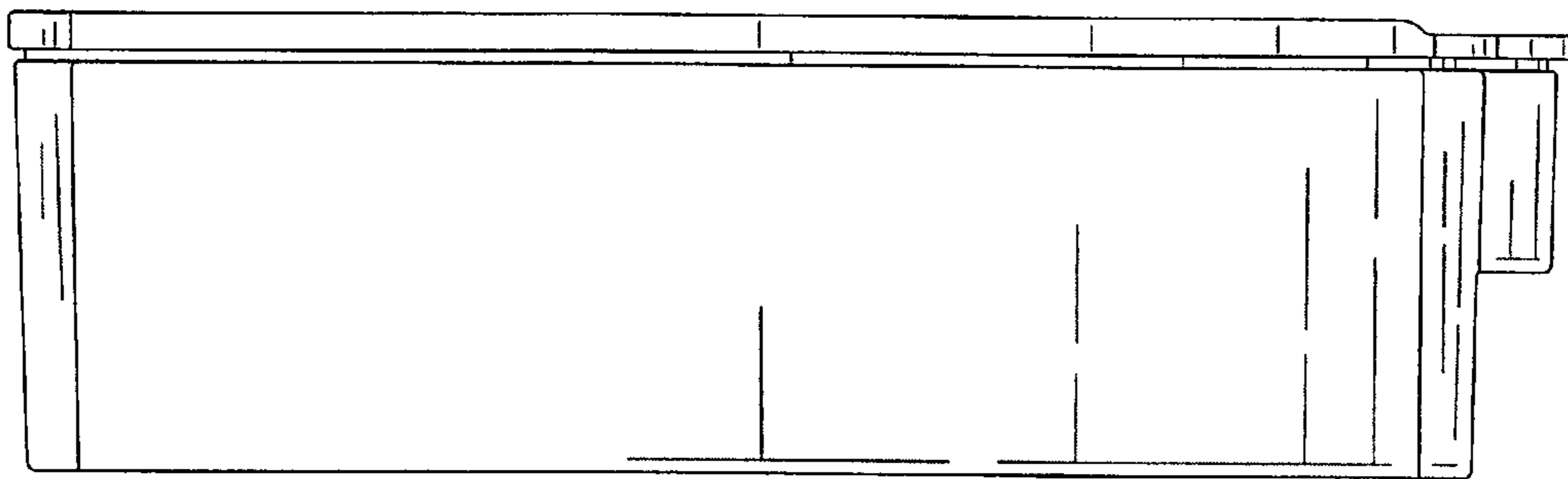

FIG. 4

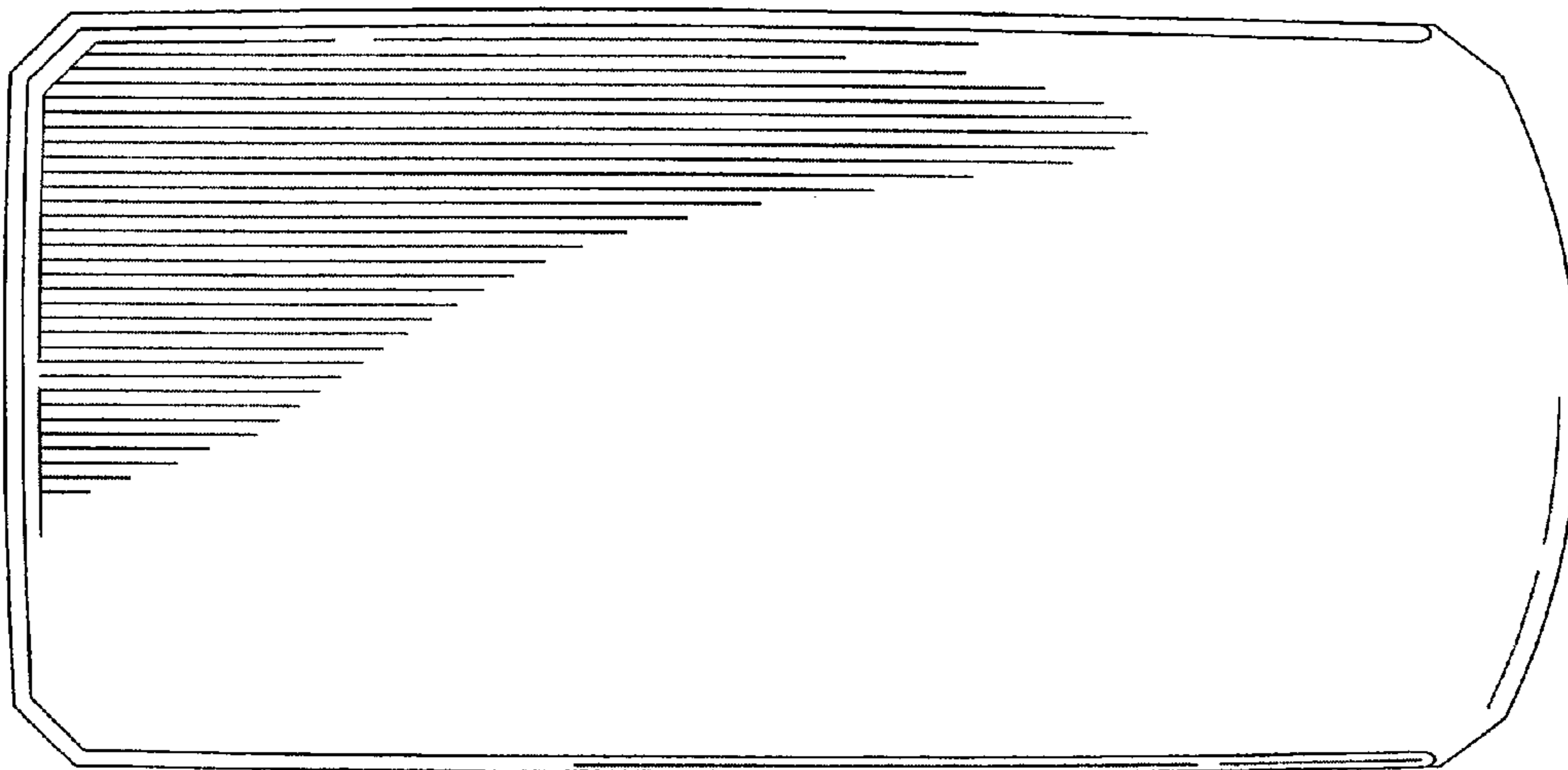

FIG. 5

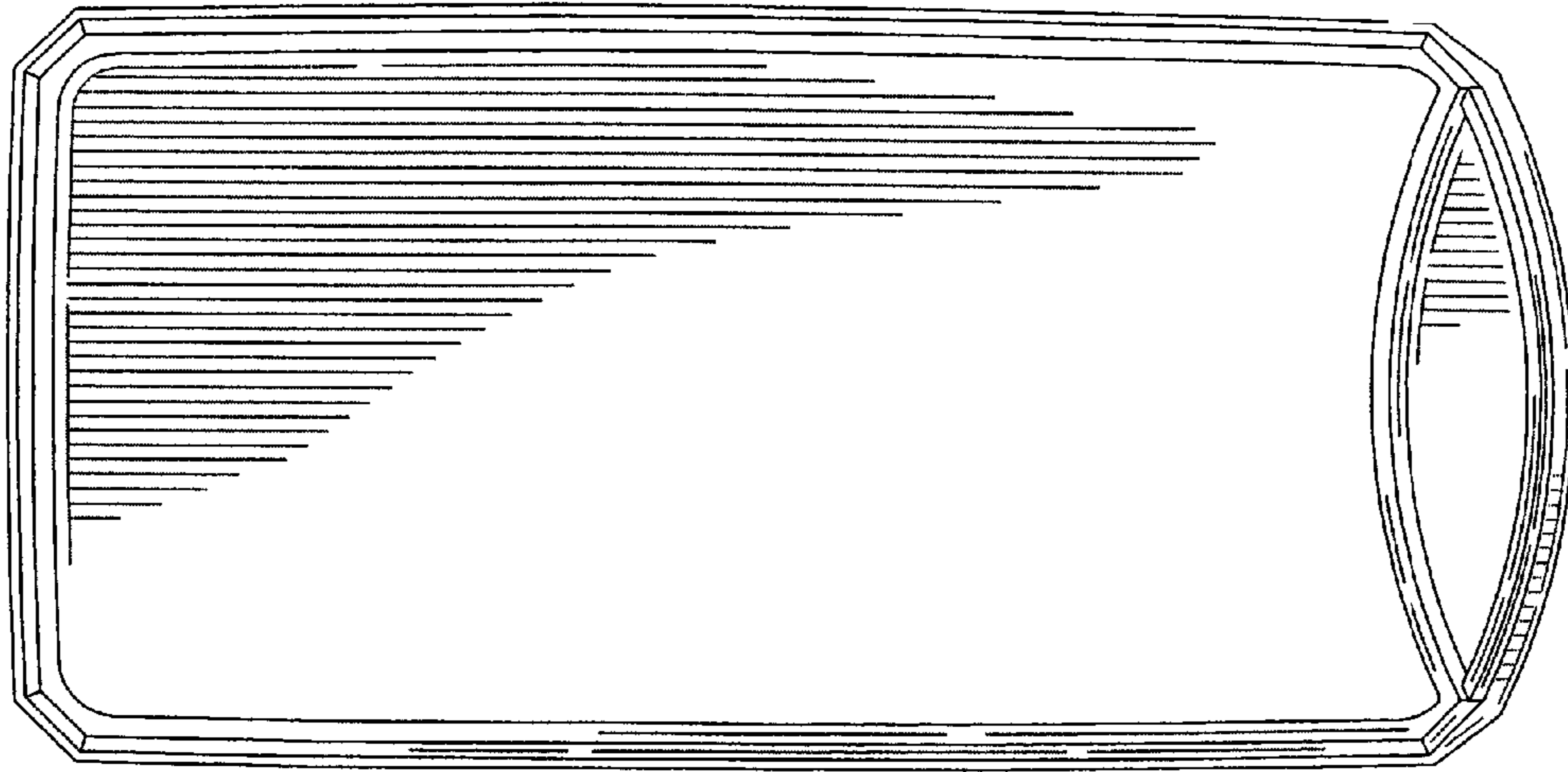

FIG. 6

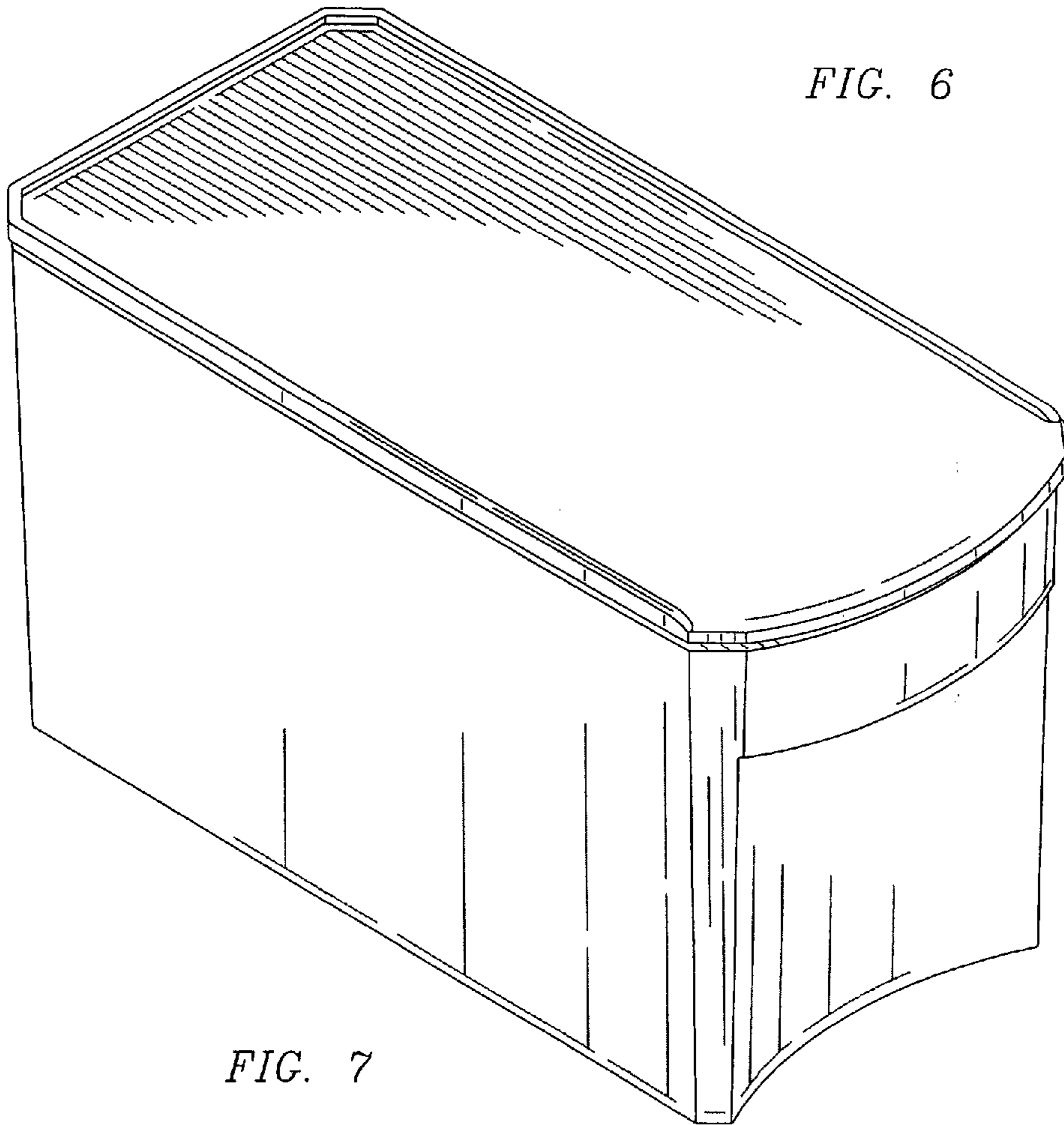

FIG. 7

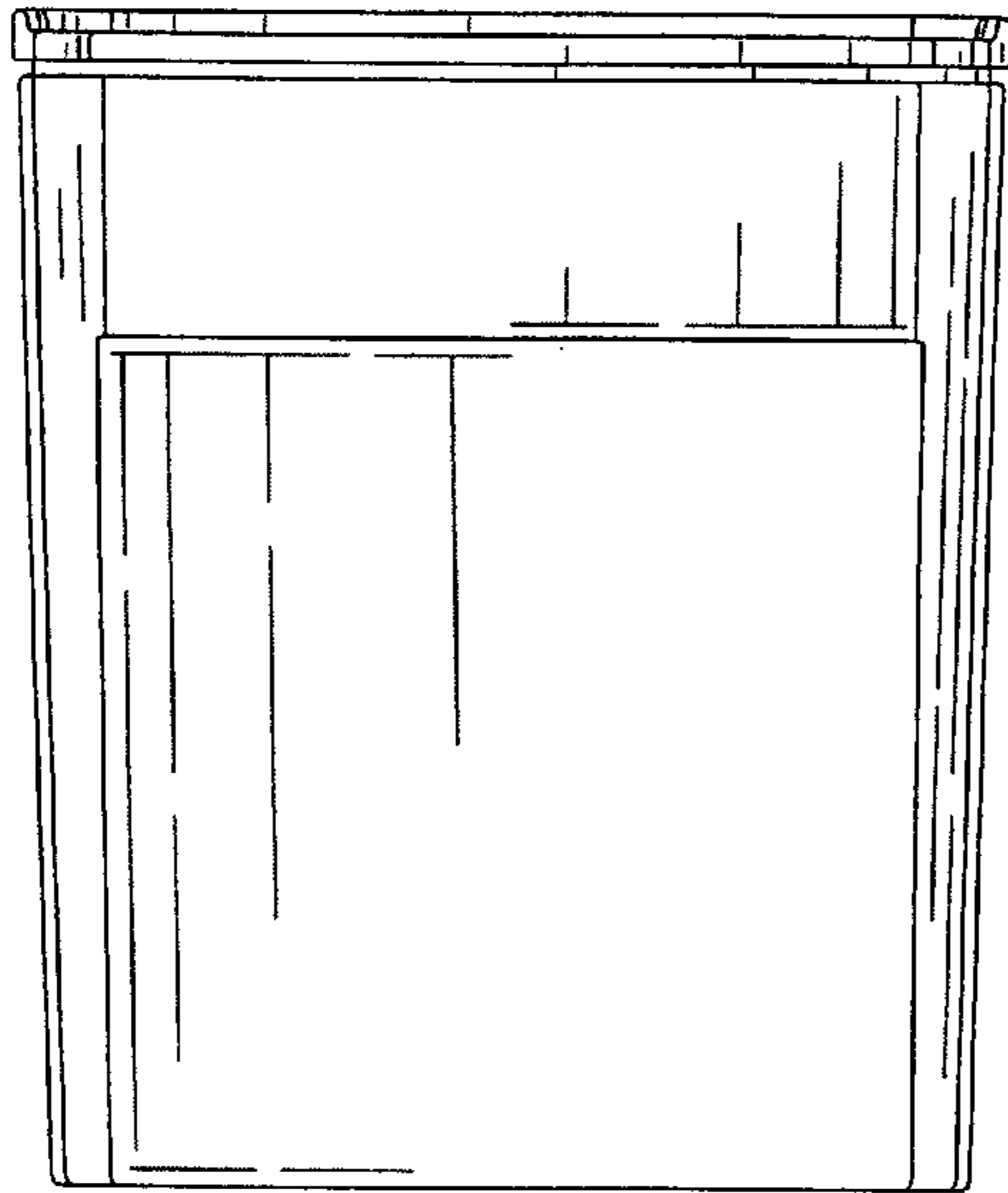

FIG. 8

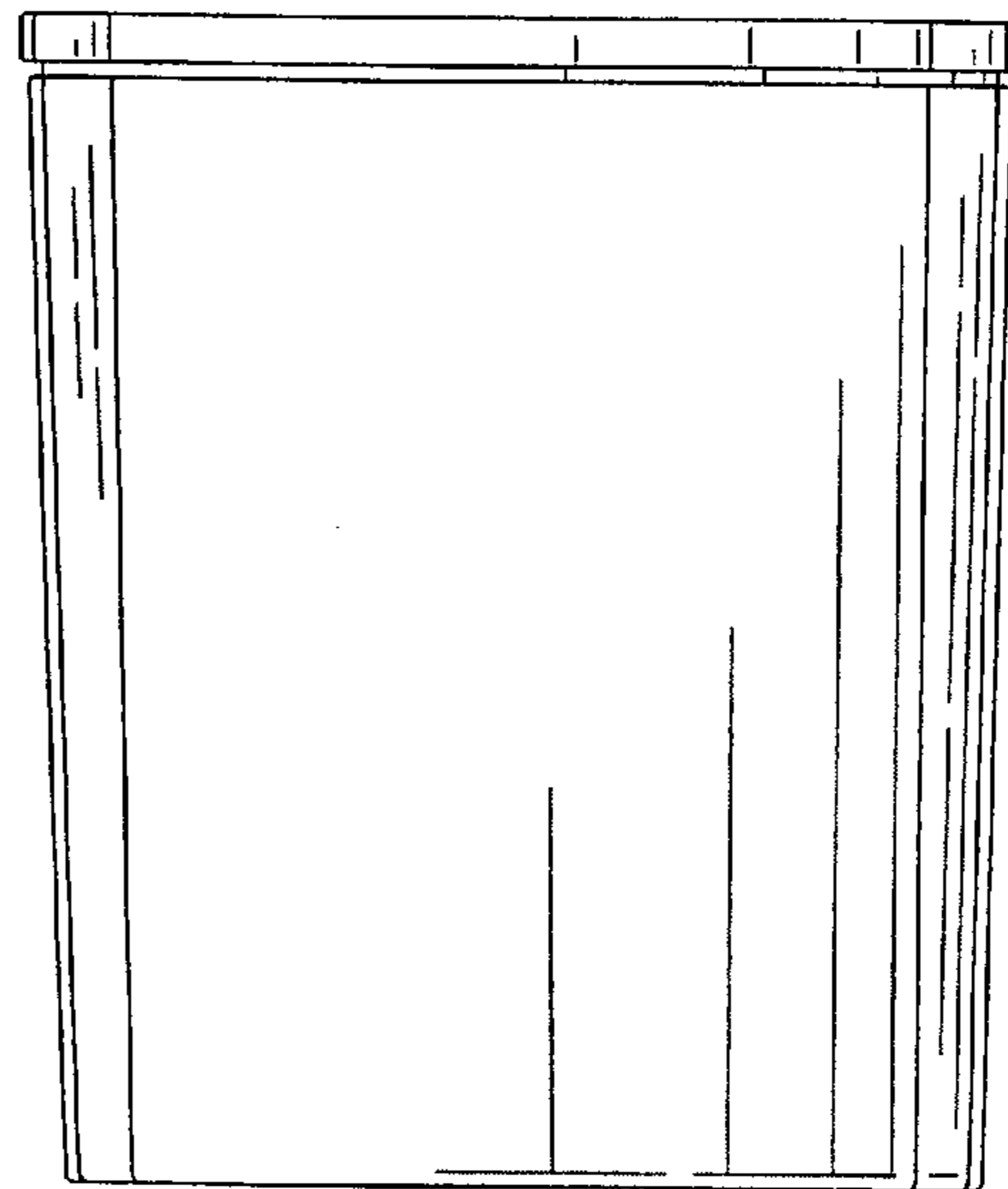

FIG. 9

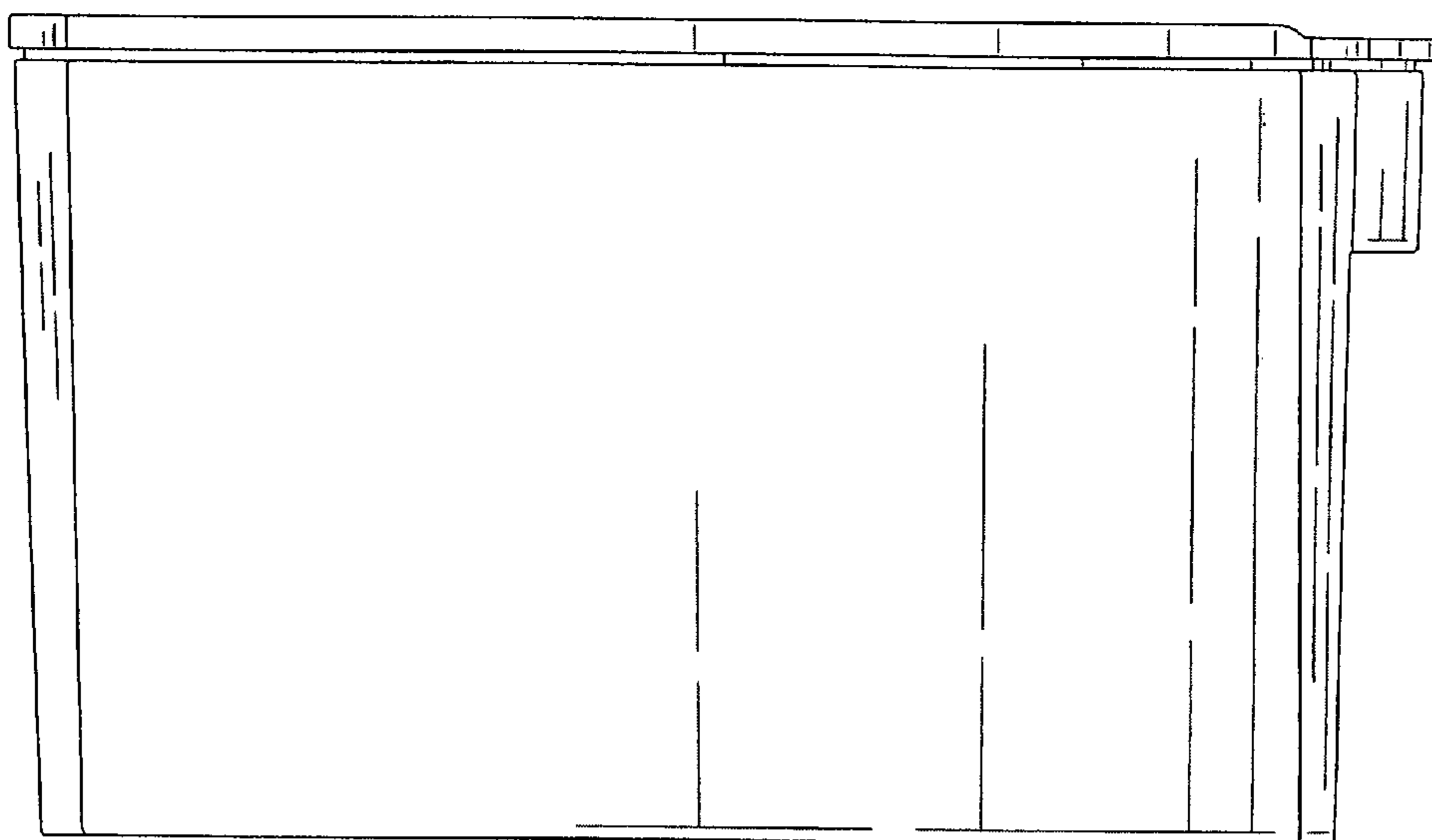

FIG. 10

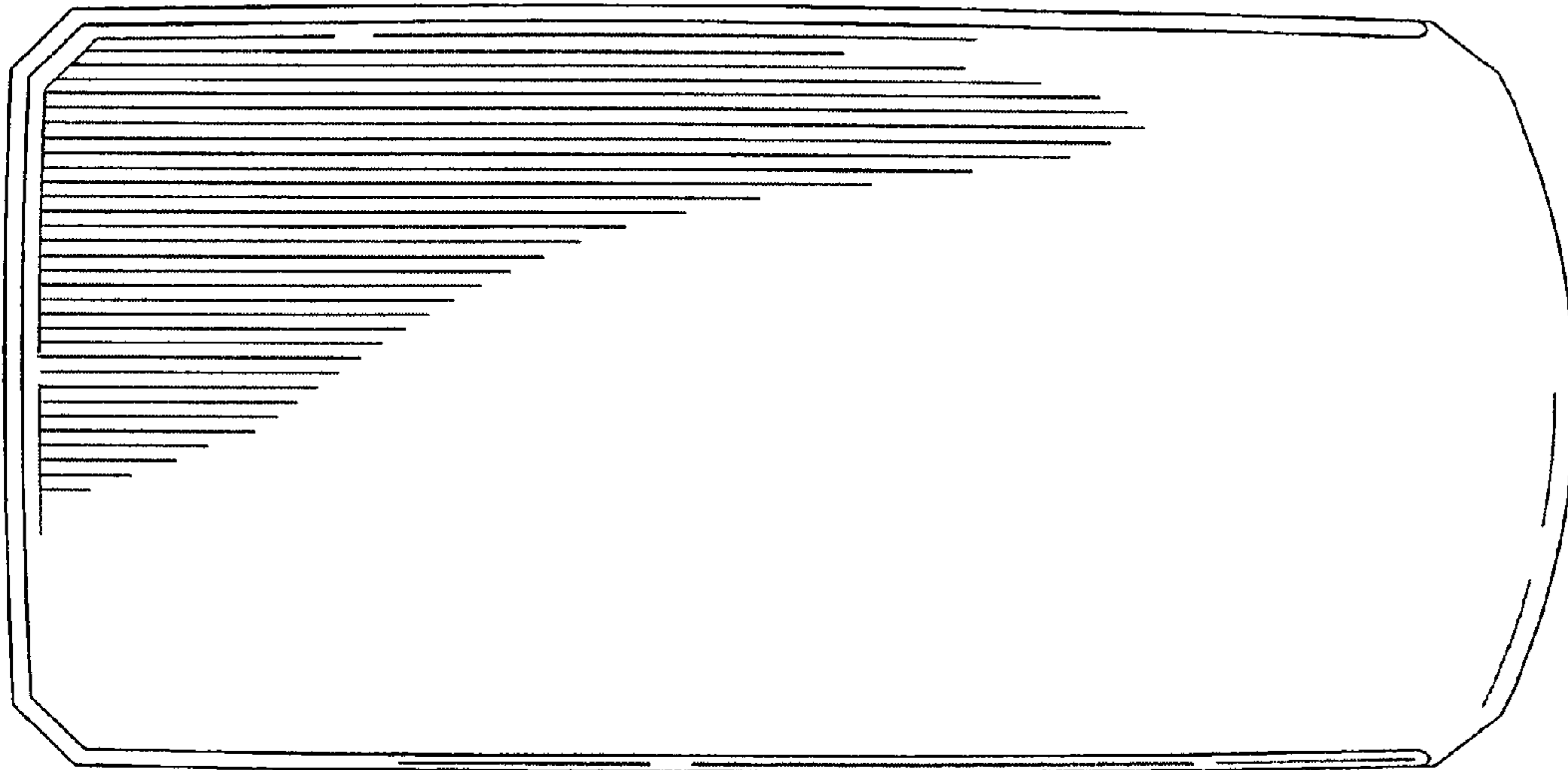

FIG. 11

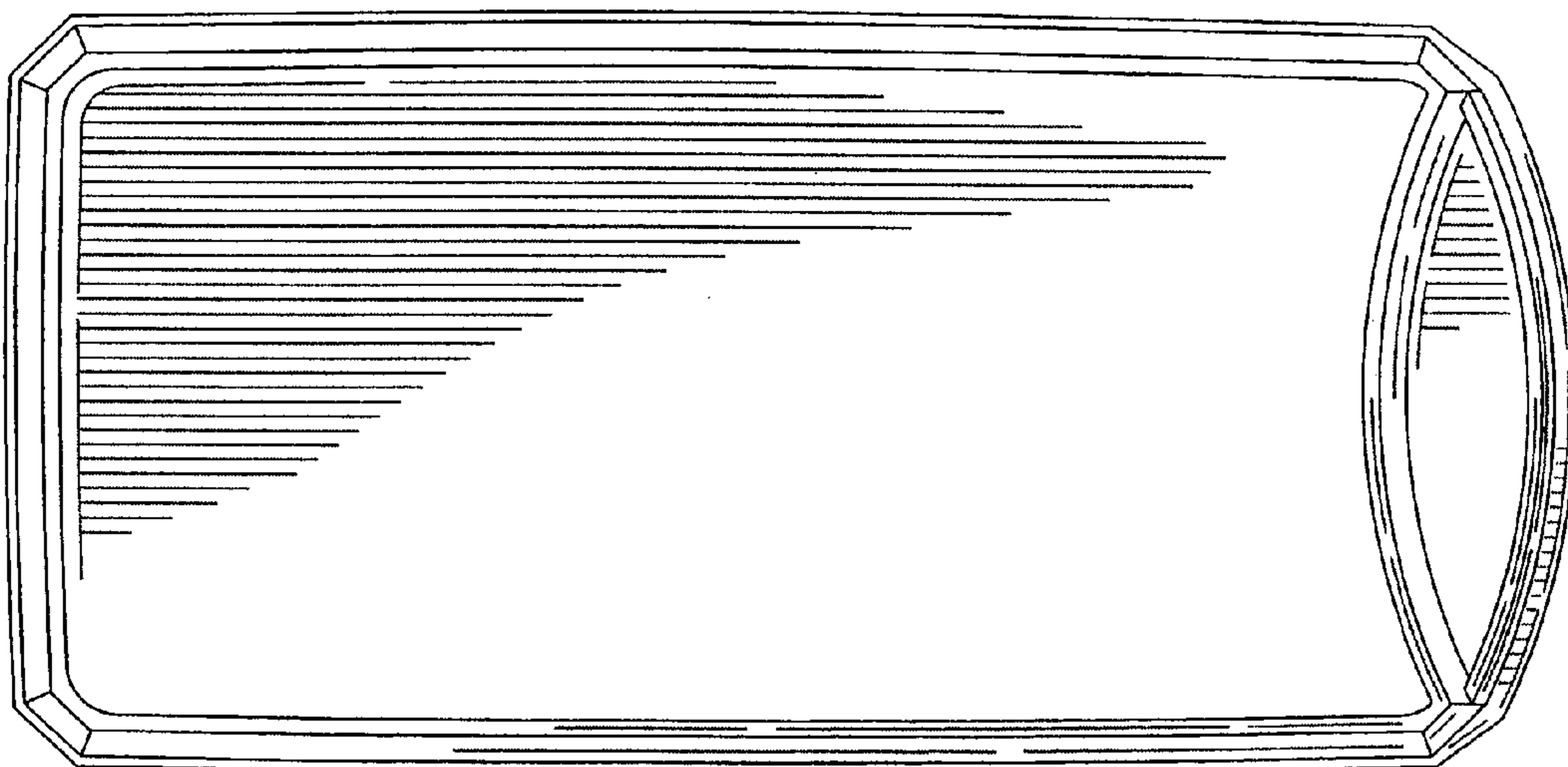

FIG. 12

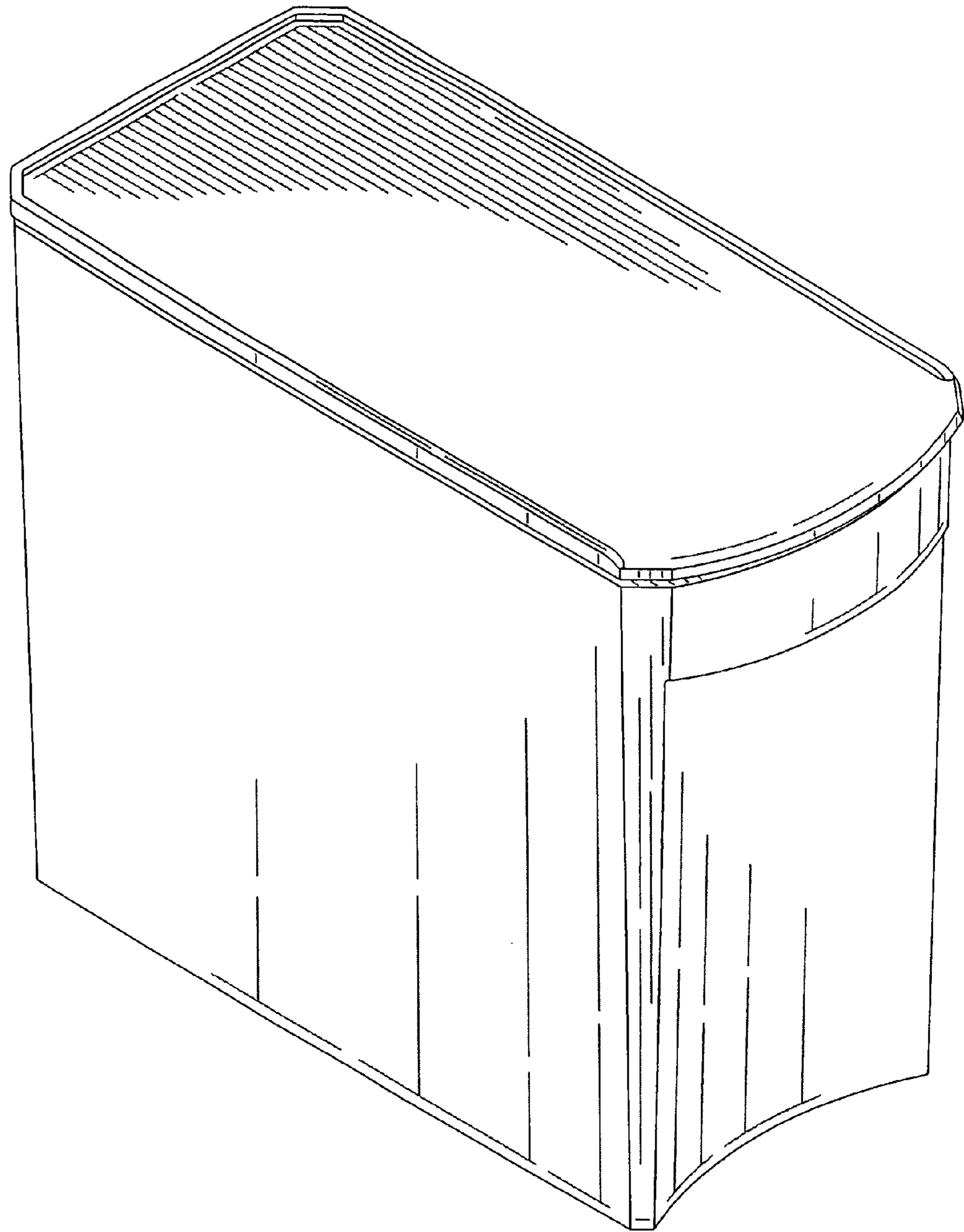

FIG. 13

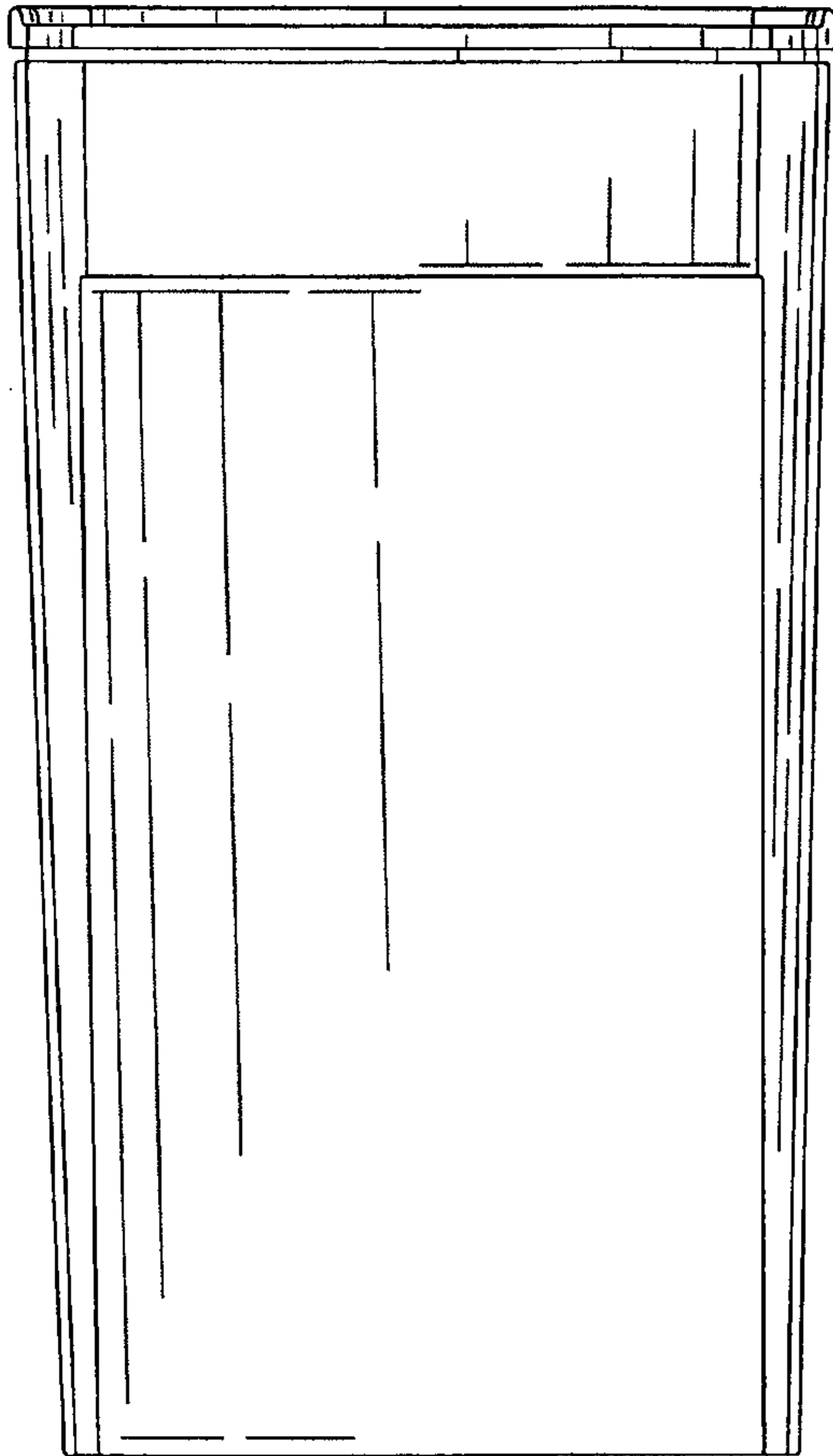

FIG. 14

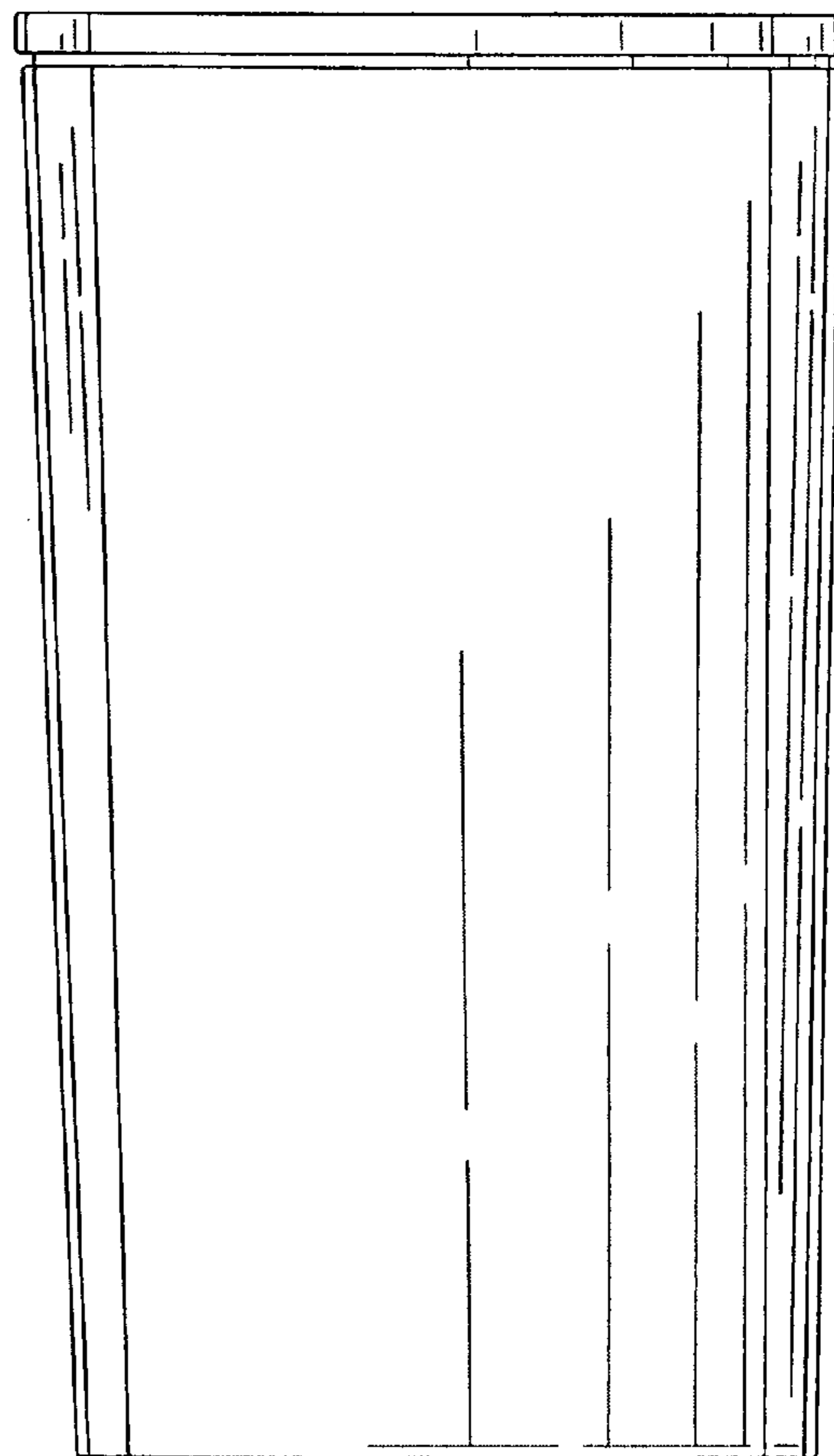

FIG. 15

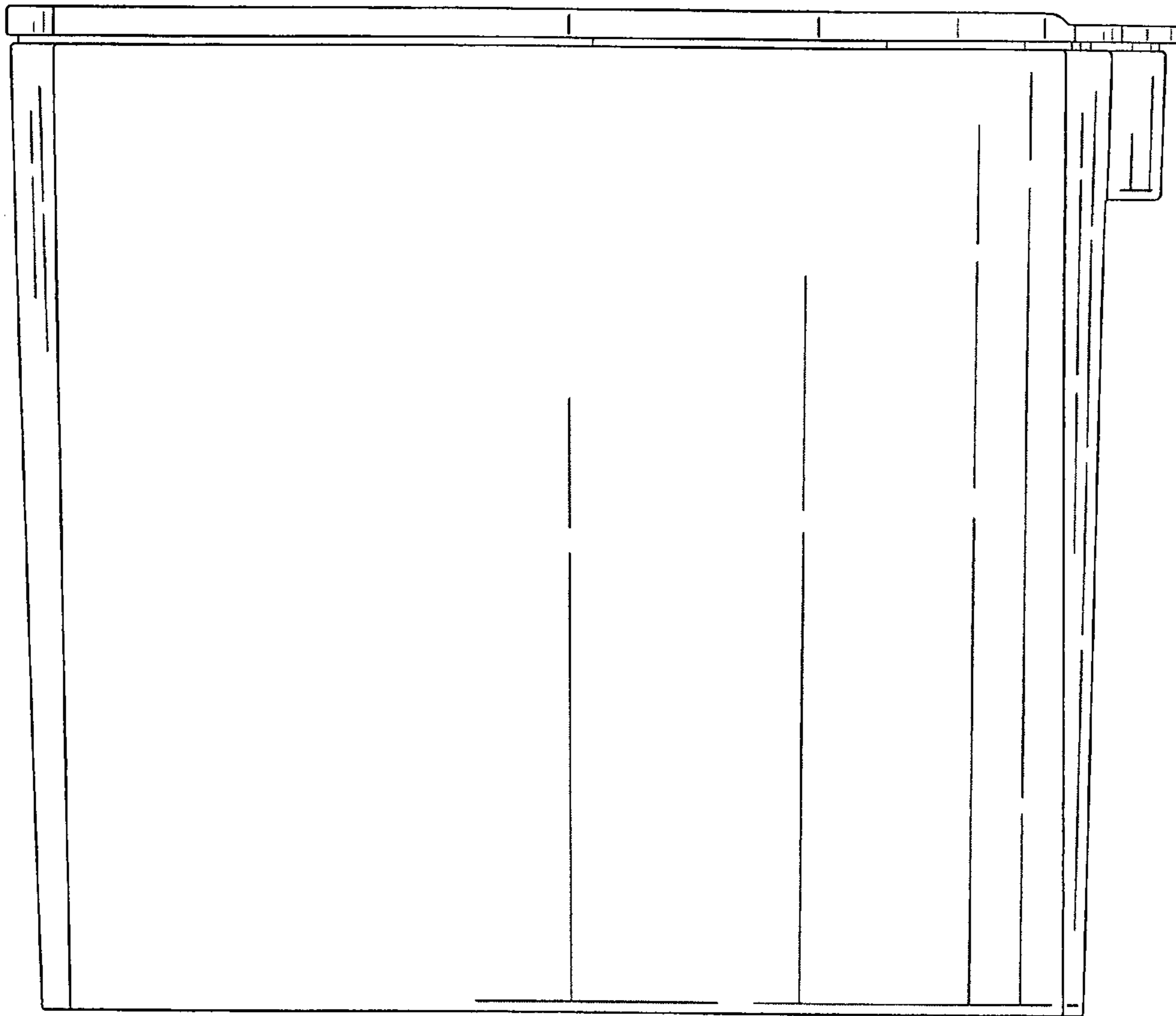

FIG. 16

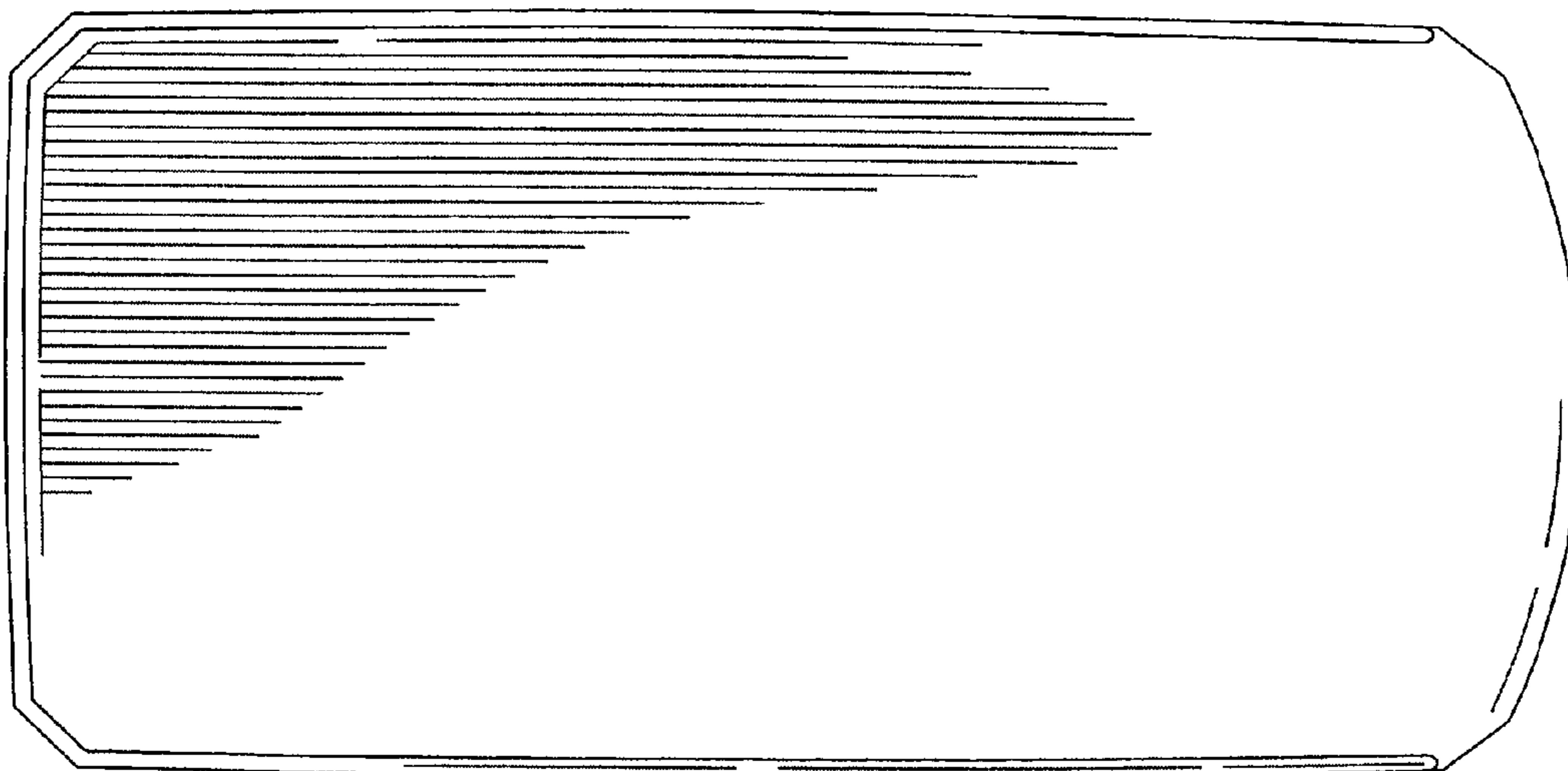

FIG. 17

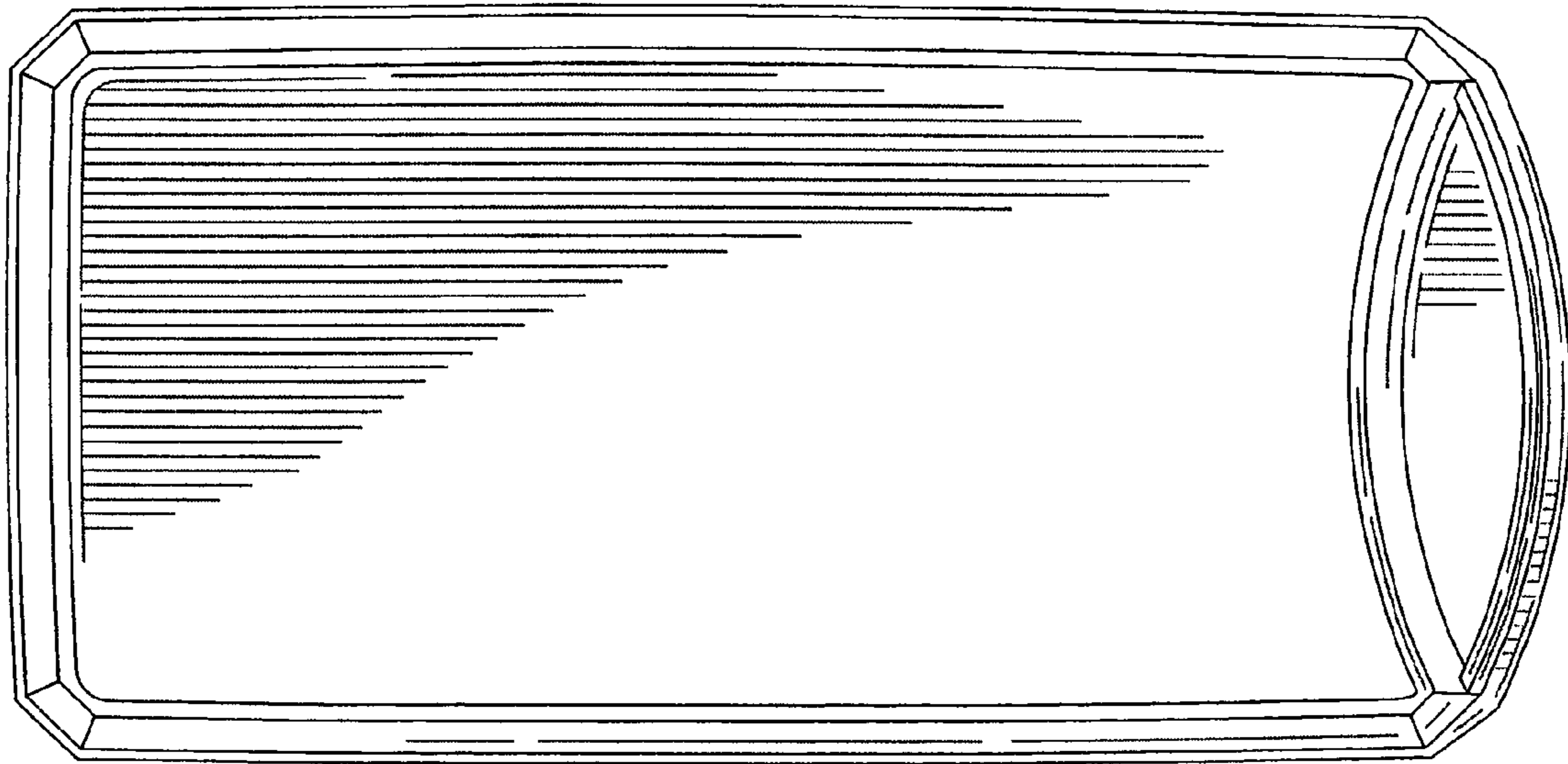

FIG. 18

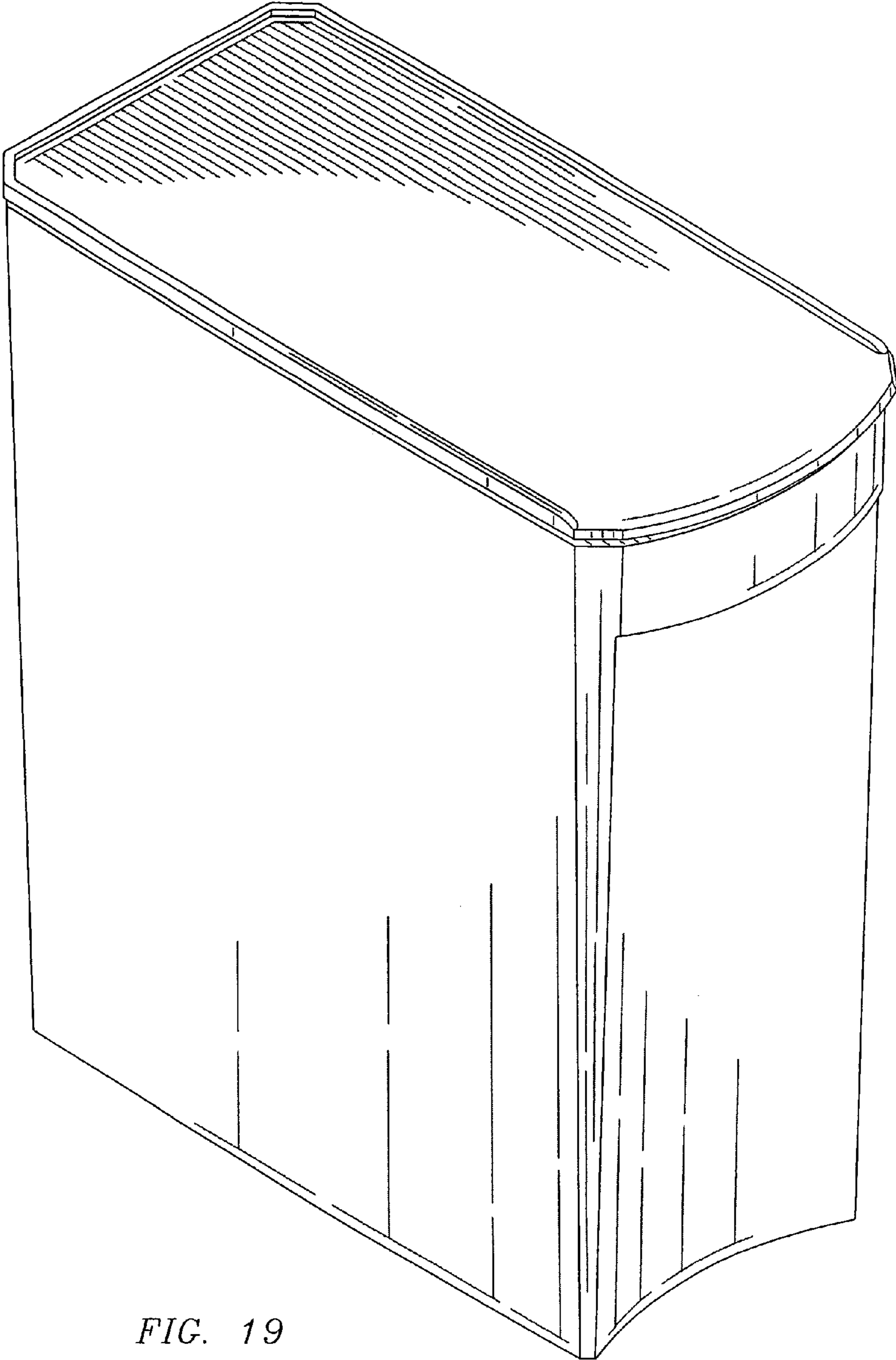

FIG. 19

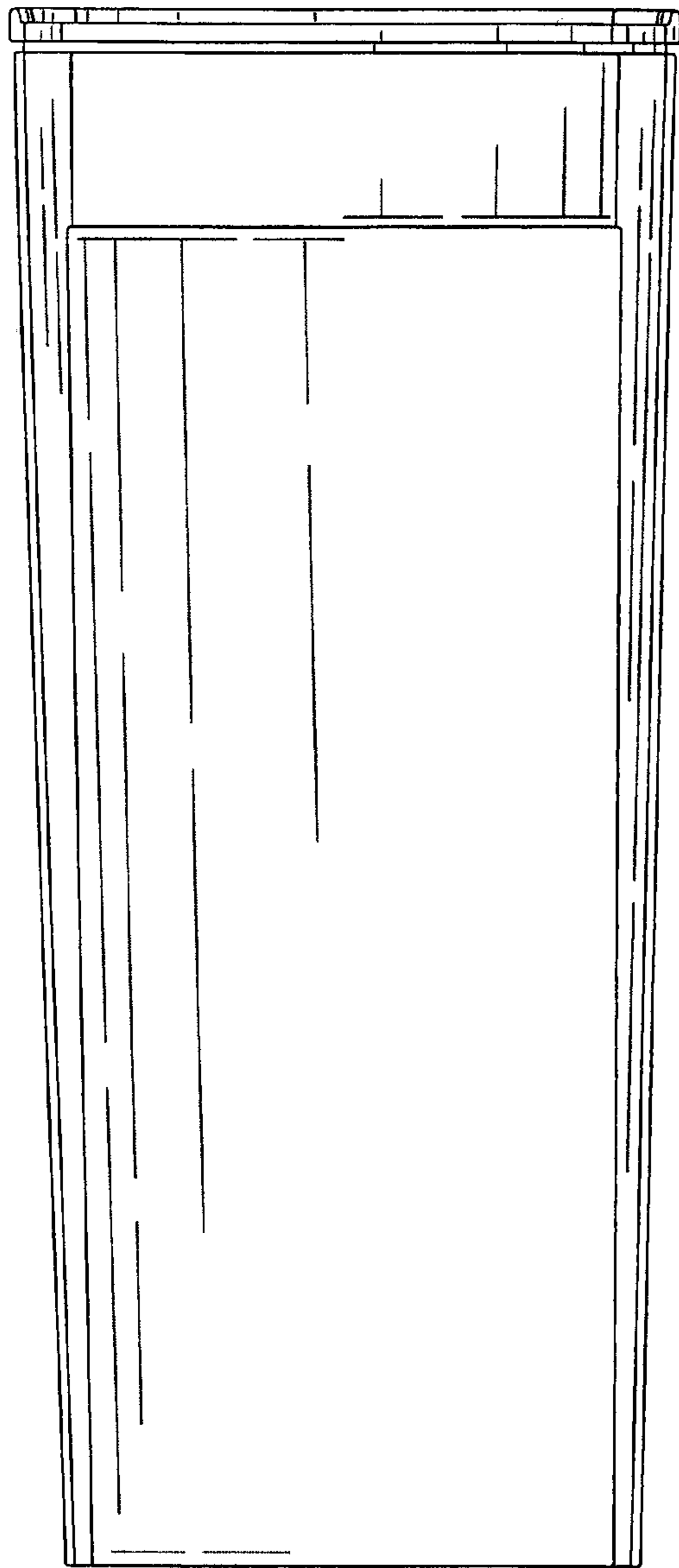

FIG. 20

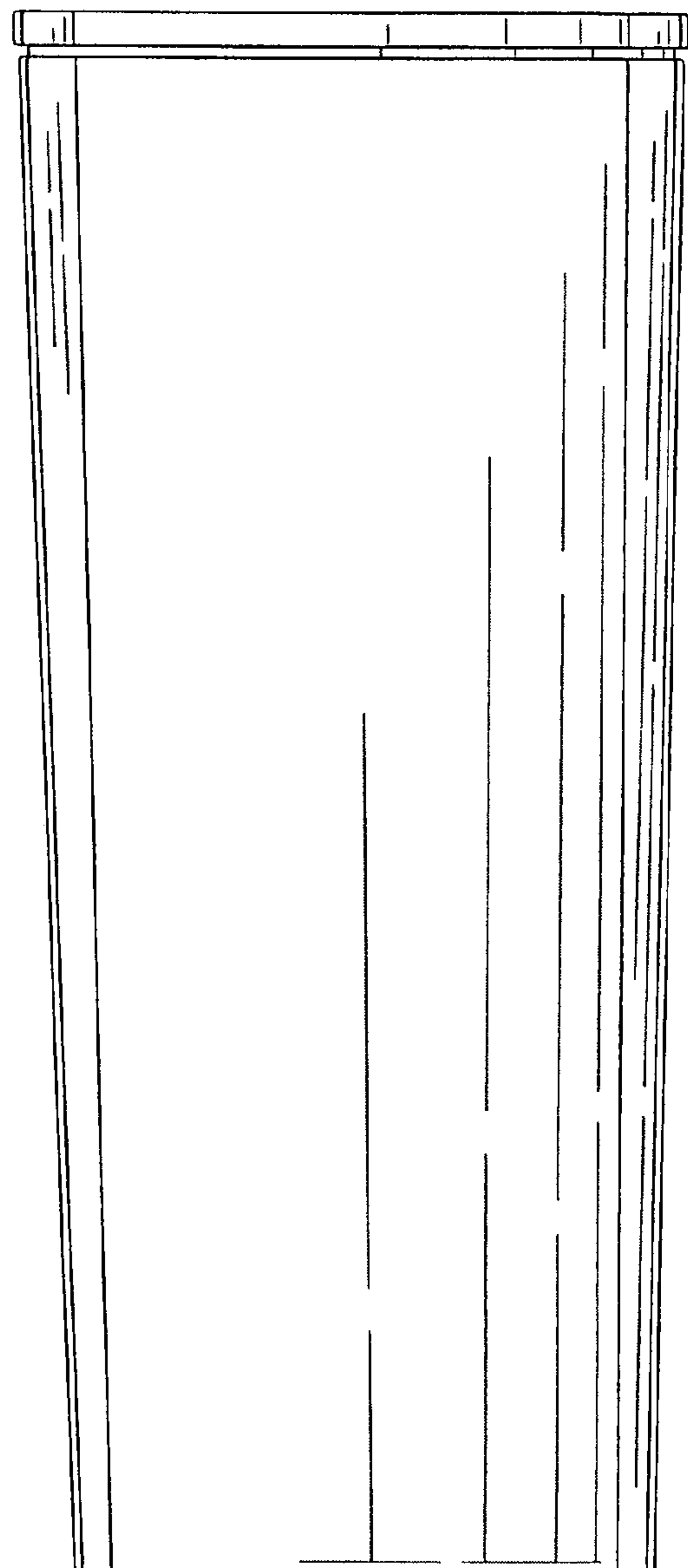

FIG. 21

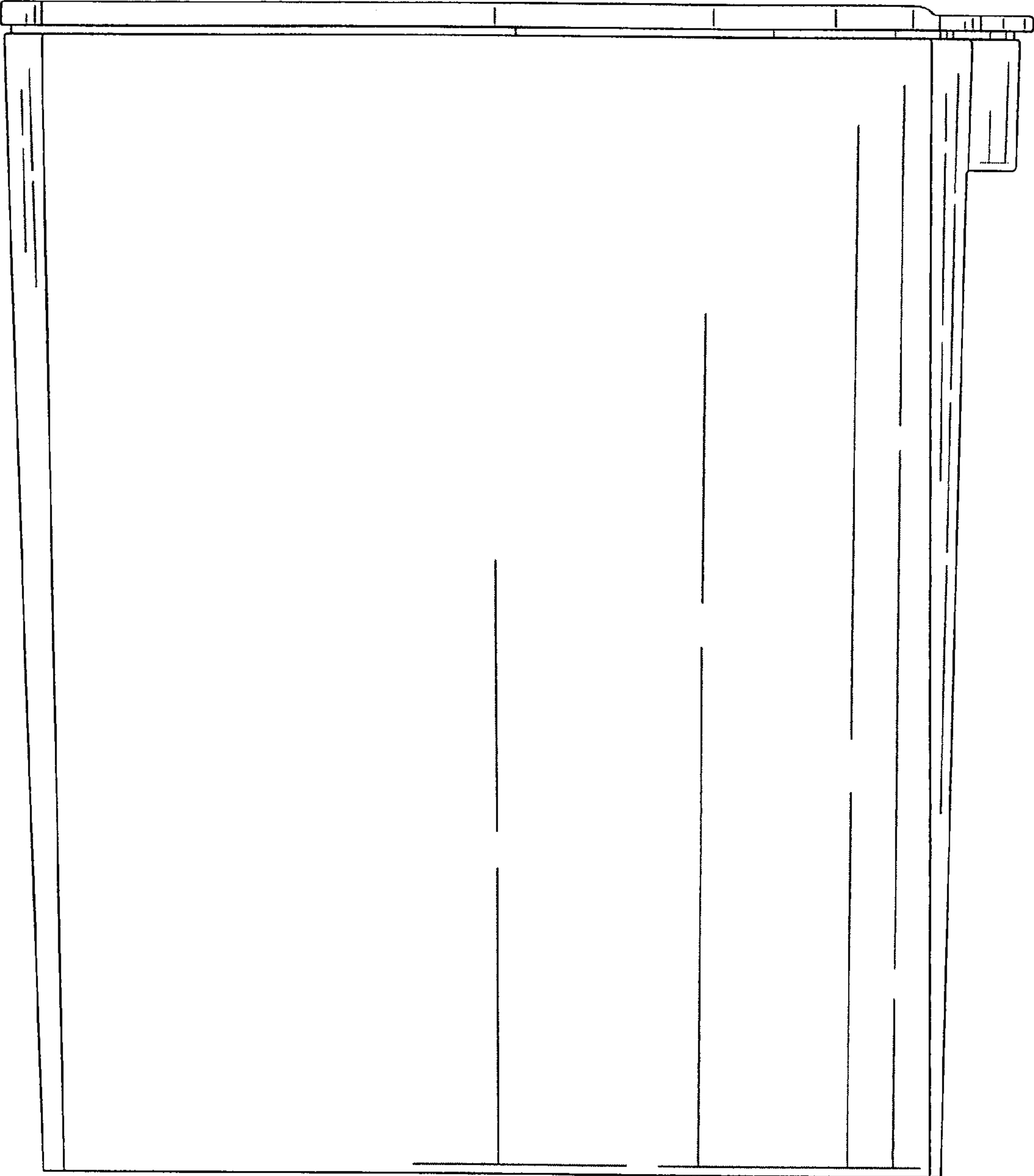

FIG. 22

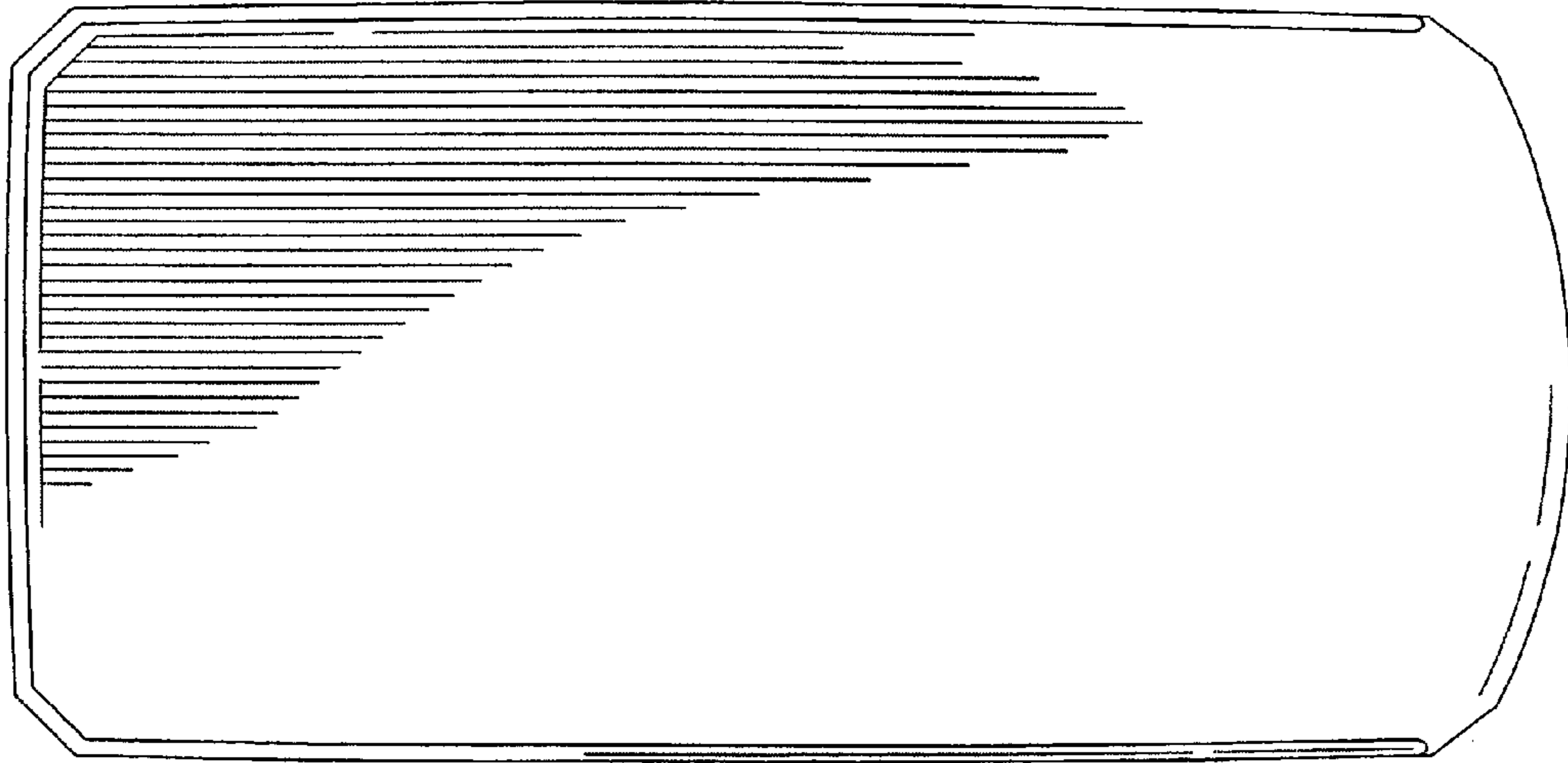

FIG. 23

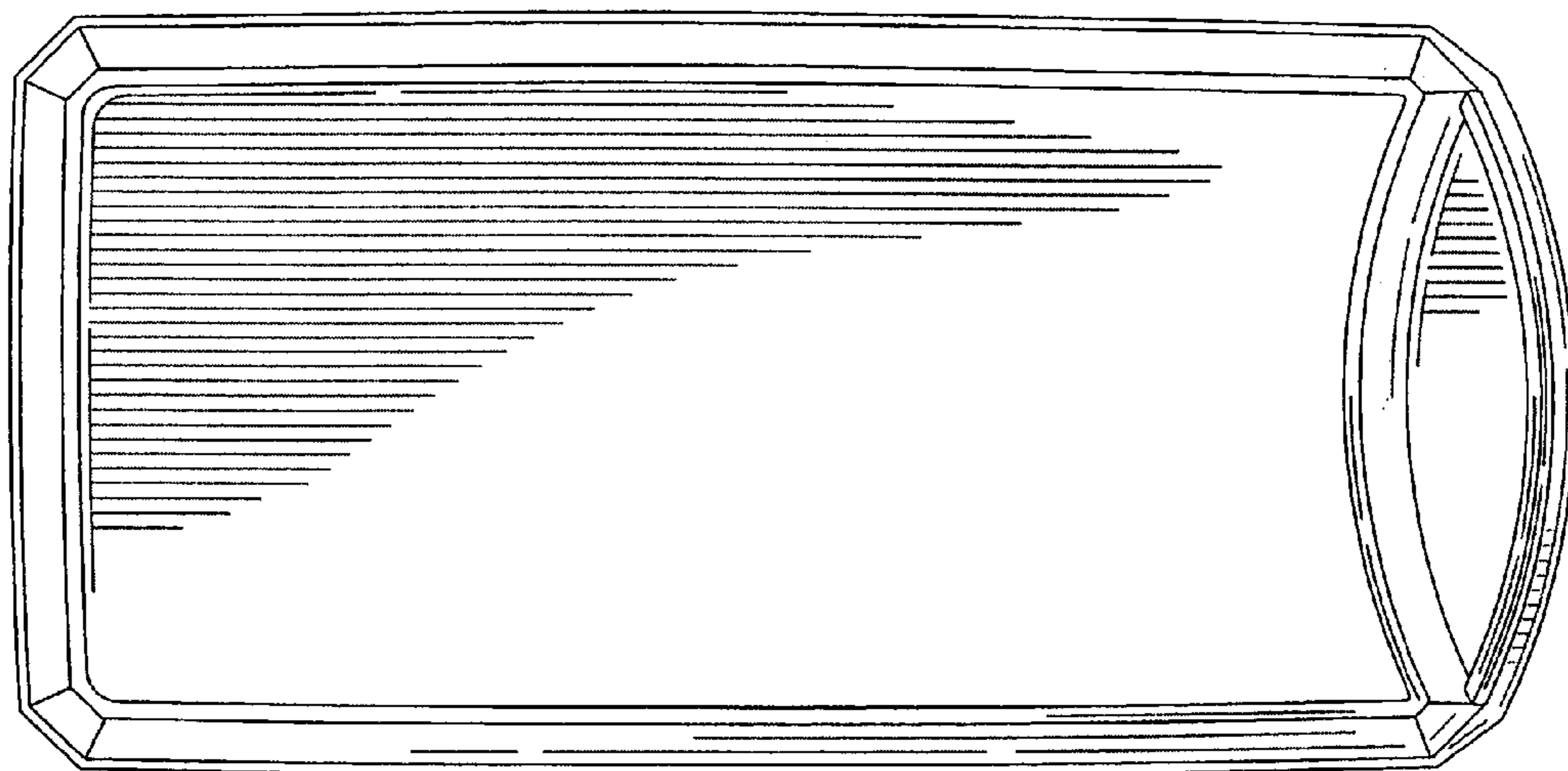

FIG. 24