

US00D509357S

(12) **United States Design Patent**
Perella et al.

(10) **Patent No.:** **US D509,357 S**
(45) **Date of Patent:** **** Sep. 13, 2005**

(54) **CAMCORDER CASE**

(75) Inventors: **Daniel Perella**, Hudson, OH (US);
Anthony Decarlo, Bay Village, OH
(US); **Vincent Thomson**, Avon Lake,
OH (US)

(73) Assignee: **Ideastream Consumer Products LLC**,
Parma, OH (US)

(**) Term: **14 Years**

(21) Appl. No.: **29/212,558**

(22) Filed: **Sep. 3, 2004**

Related U.S. Application Data

(62) Division of application No. 29/180,362, filed on Apr. 23,
2003, now Pat. No. Des. 496,791.

(51) **LOC (8) Cl.** **03-01**

(52) **U.S. Cl.** **D3/267; D3/268; D3/273**

(58) **Field of Search** D3/208, 215, 219,
D3/225, 226, 243, 263, 267, 268, 270,
272, 273, 276, 283, 285, 287, 289-291,
301; D6/631; 119/72; 190/19, 37, 119,
120; 206/316.1, 316.2; 224/583, 612, 908;
353/72

(56) **References Cited**

U.S. PATENT DOCUMENTS

1,533,856 A	4/1925	Harrison	
D67,730 S	6/1925	Wheary	D3/272
D129,108 S	8/1941	Sprague	
2,268,450 A	12/1941	Haggett	
2,626,025 A	1/1953	Sherman	
3,605,961 A *	9/1971	Marrion	190/120
3,828,899 A *	8/1974	Scott	190/120
4,119,181 A *	10/1978	Jones	190/107
4,509,622 A	4/1985	Morszeck	190/119

D288,863 S	3/1987	Vuitton	D3/289
4,744,445 A *	5/1988	Anderson et al.	190/107
D296,153 S	6/1988	Reichow	D6/631
4,813,542 A *	3/1989	Thompson et al.	206/504
D337,657 S *	7/1993	March et al.	D3/272
D340,574 S *	10/1993	Weinreb	D3/268
D351,502 S	10/1994	Weir et al.	D3/272
D378,164 S	2/1997	Lee	D3/276
D386,614 S	11/1997	Smith	D3/291
D388,251 S	12/1997	Smith	D3/291
5,755,180 A	5/1998	Smith	119/72
D414,037 S	9/1999	Akaike et al.	D3/276
D415,614 S	10/1999	Akaike et al.	D3/276
D419,766 S	2/2000	Rekuc	D3/272
D467,423 S	12/2002	Wolf	D3/276
D496,791 S *	10/2004	Perella et al.	D3/267
D497,252 S *	10/2004	Perella et al.	D3/294
D498,049 S *	11/2004	Perella et al.	D3/273

* cited by examiner

Primary Examiner—Celia A. Murphy

(74) *Attorney, Agent, or Firm*—Pillsbury Winthrop LLP

(57) **CLAIM**

The ornamental design for a camcorder case, as shown and described.

DESCRIPTION

FIG. 1 is perspective view of a camcorder case embodying our new design;

FIG. 2 is a front elevational view thereof;

FIG. 3 is a rear elevational view thereof;

FIG. 4 is a left side elevational view thereof, the right side being a mirror image;

FIG. 5 is a top plan view thereof; and,

FIG. 6 is a perspective view thereof, showing an attached shoulder strap.

The broken line showing of a shoulder strap illustrates the portion of the design that forms no part of the claim.

1 Claim, 6 Drawing Sheets

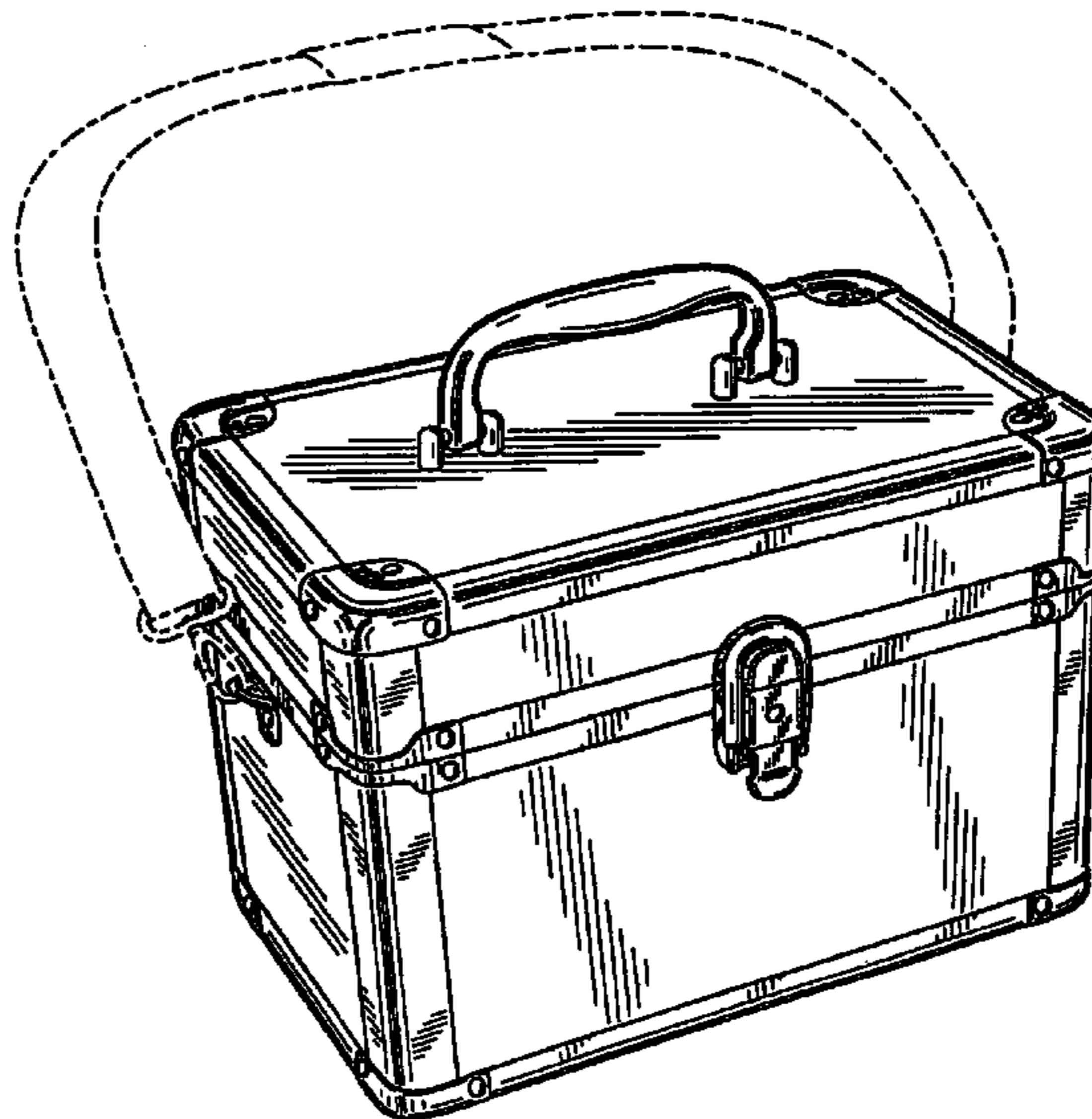
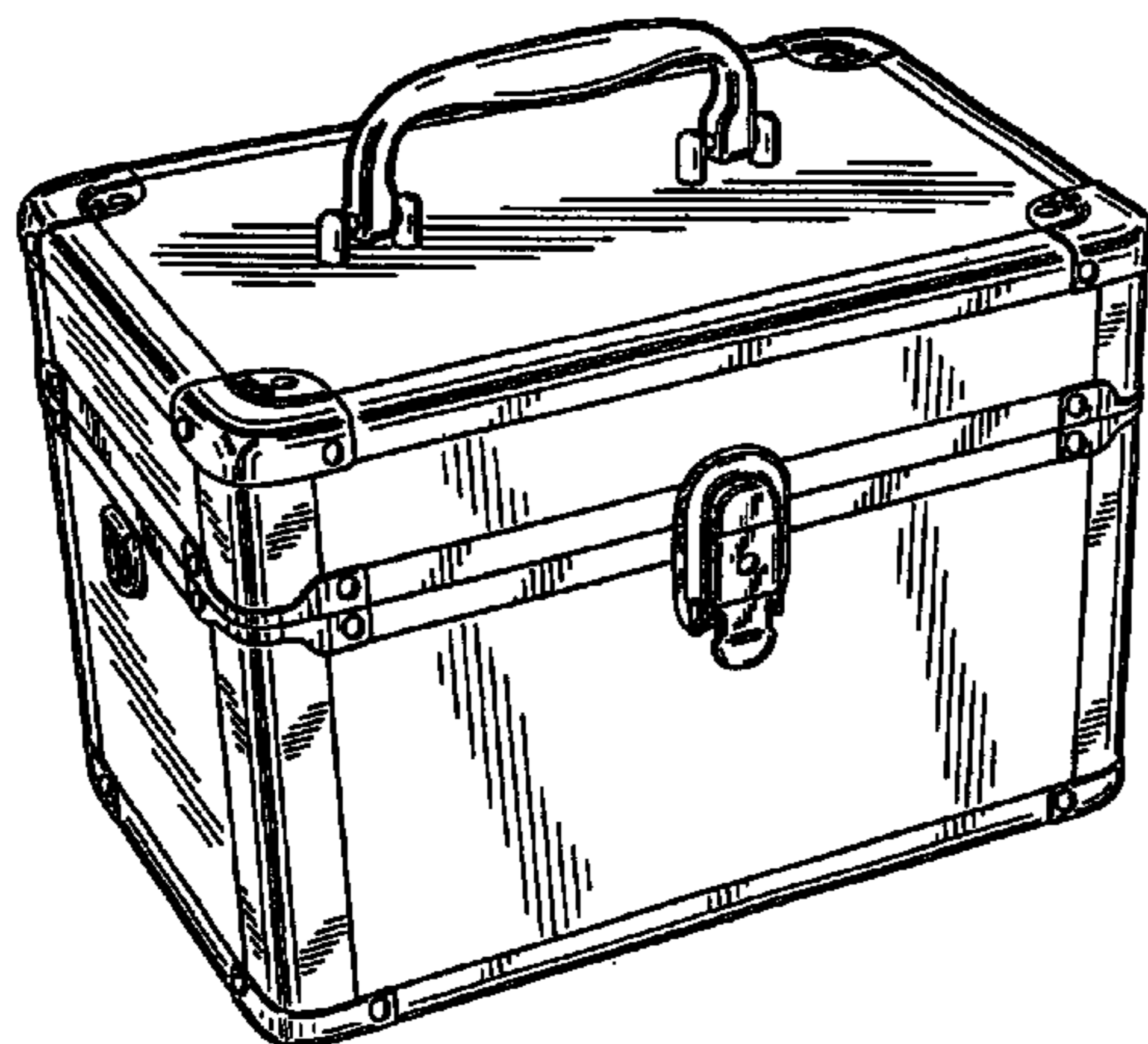

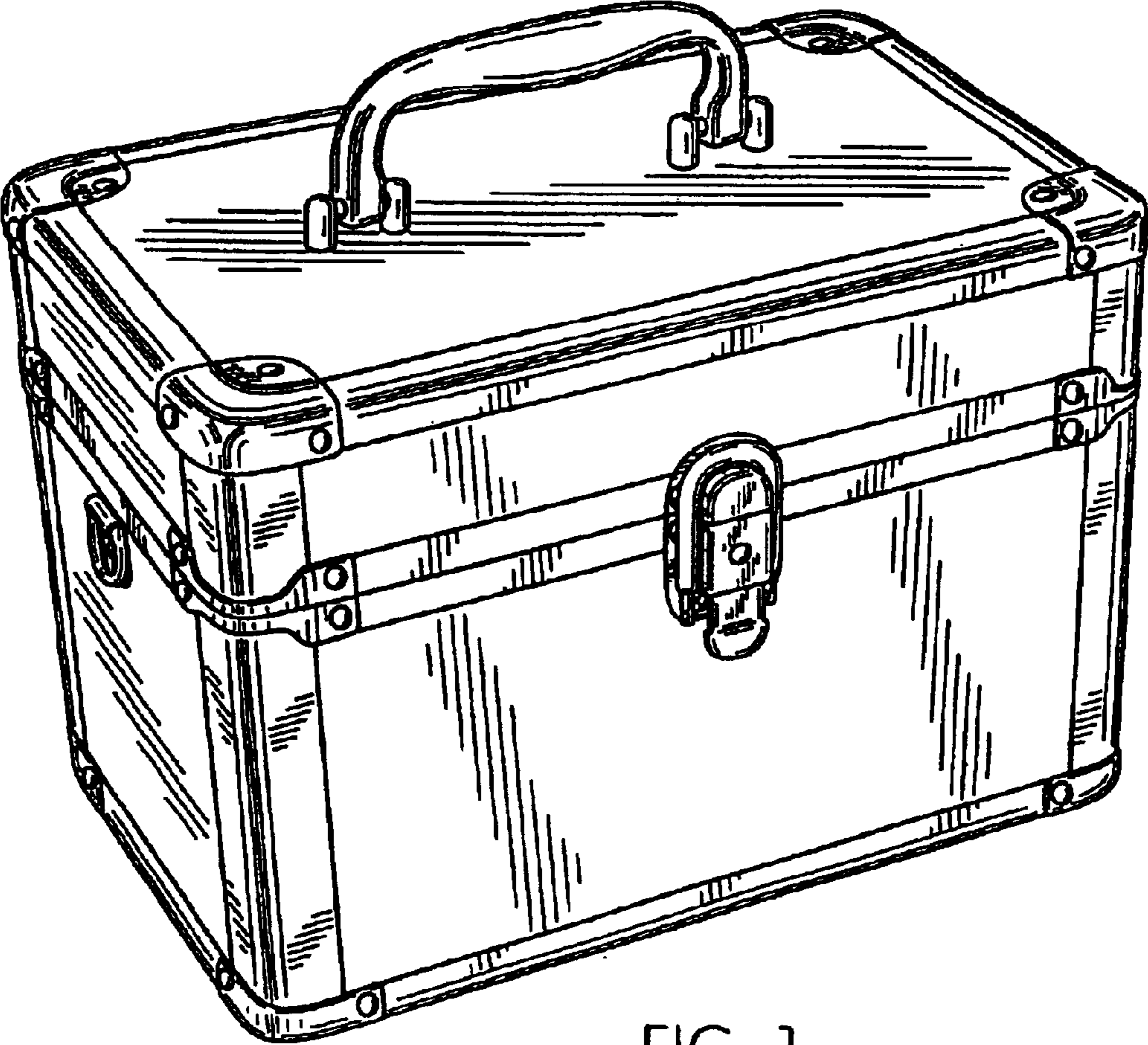

FIG. 1

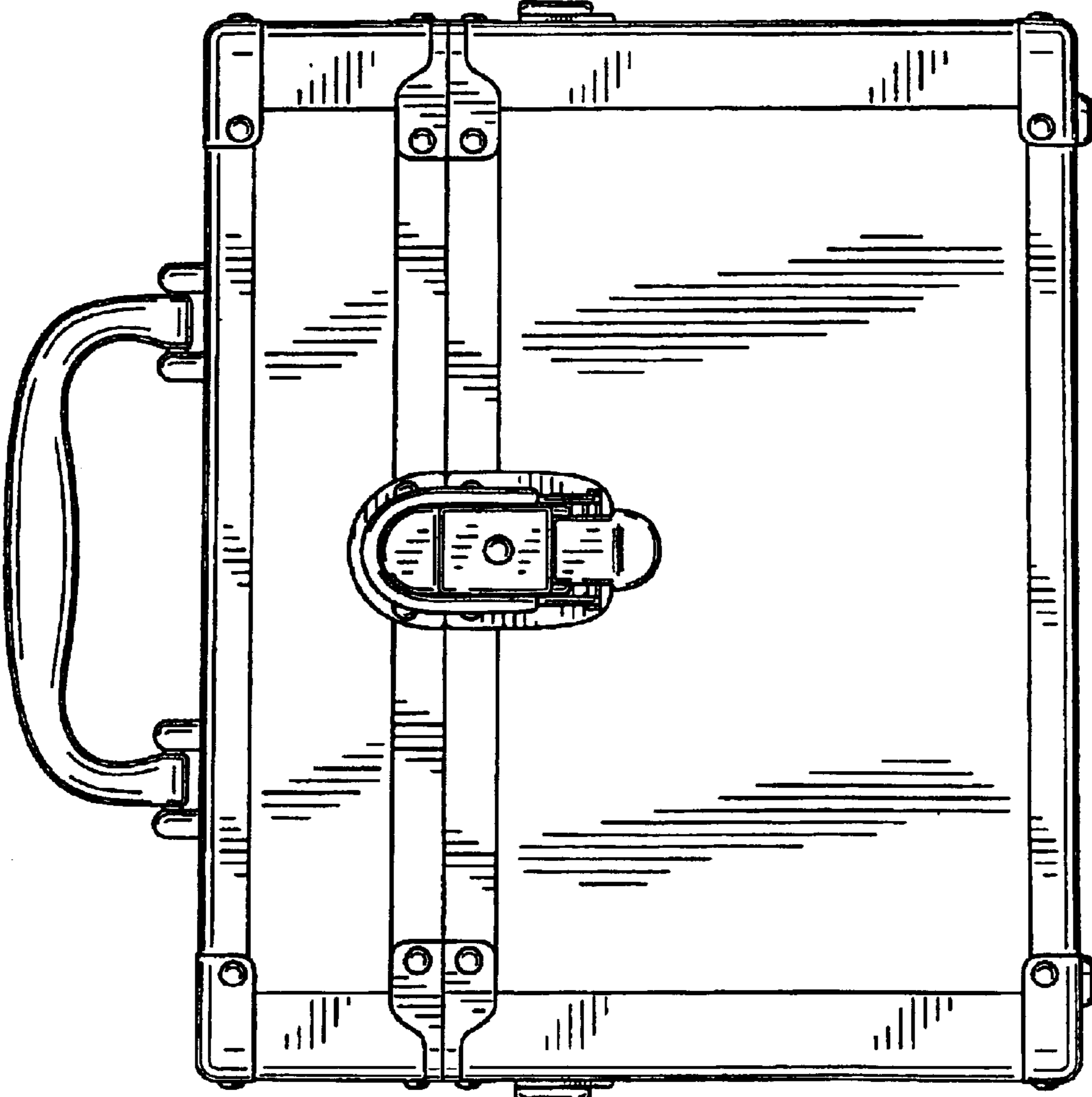

FIG. 2

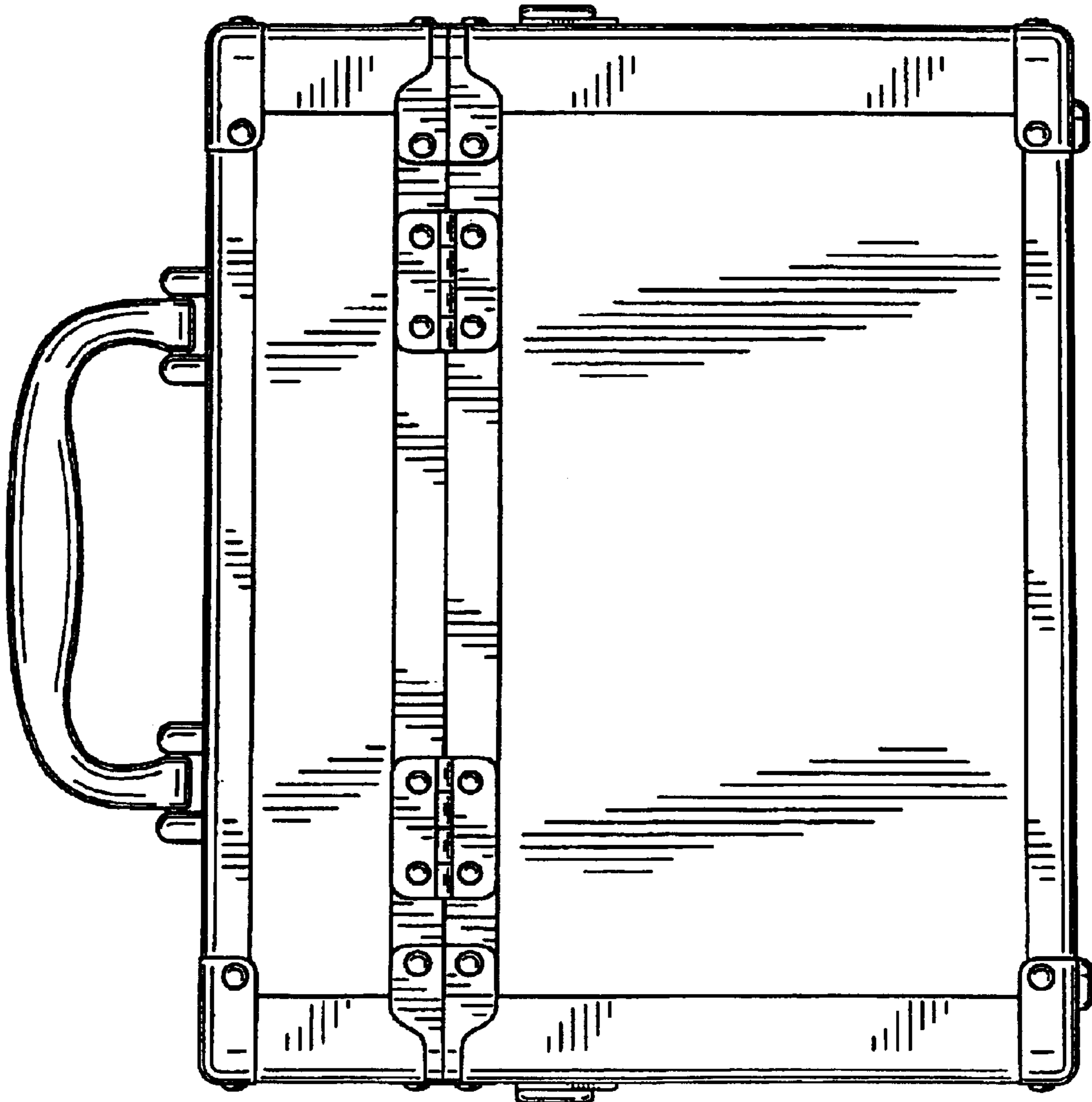

FIG. 3

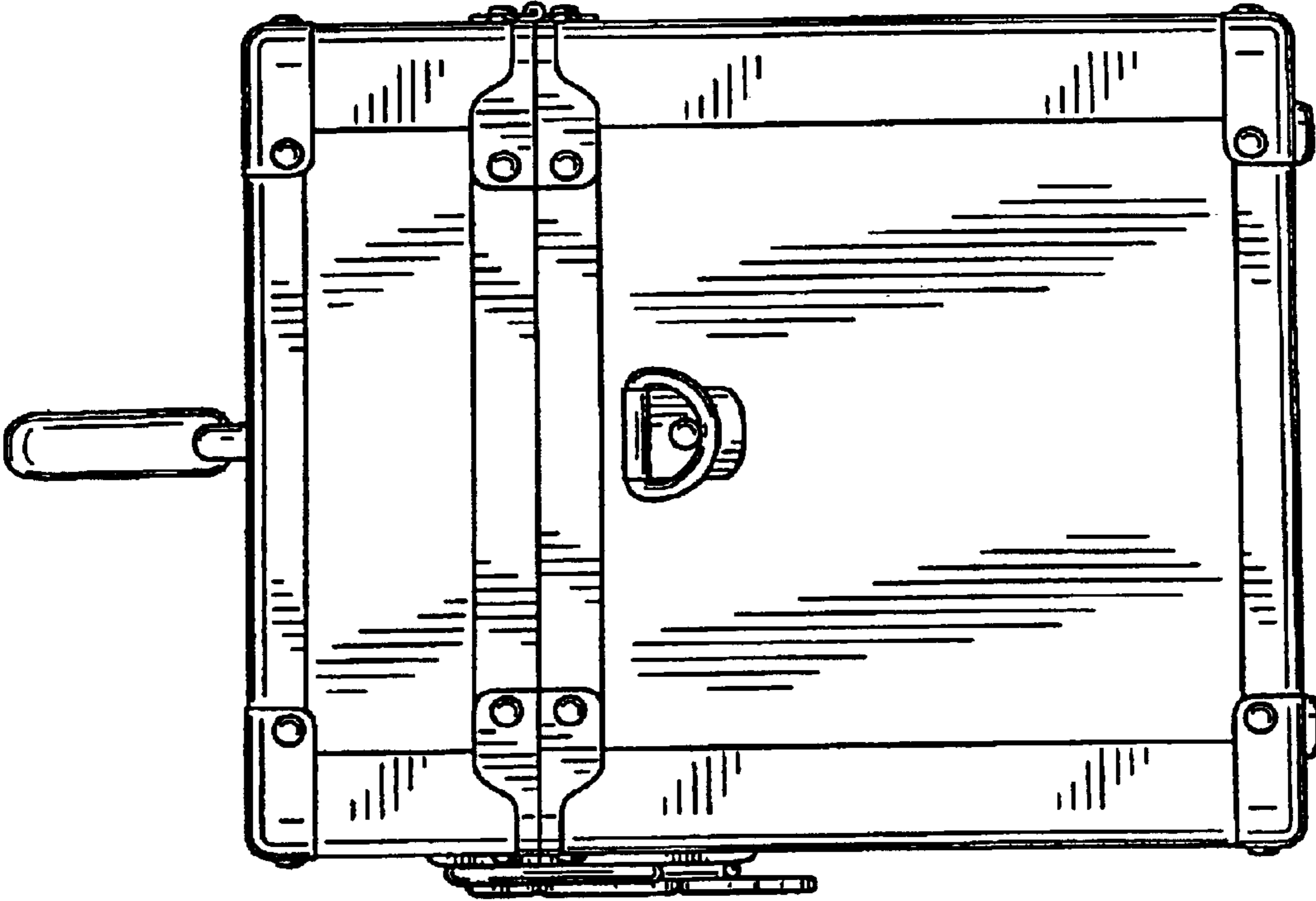

FIG. 4

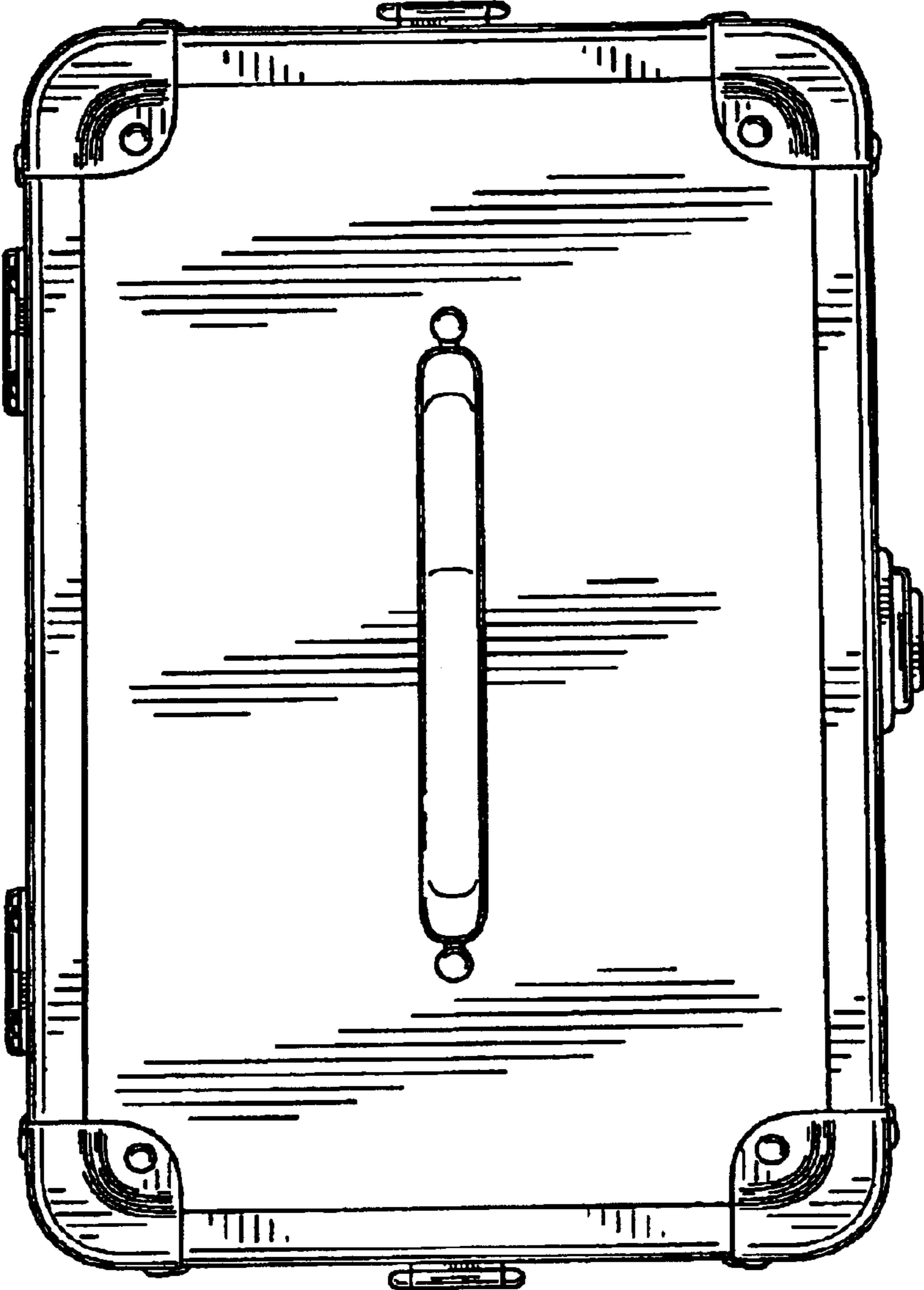

FIG. 5

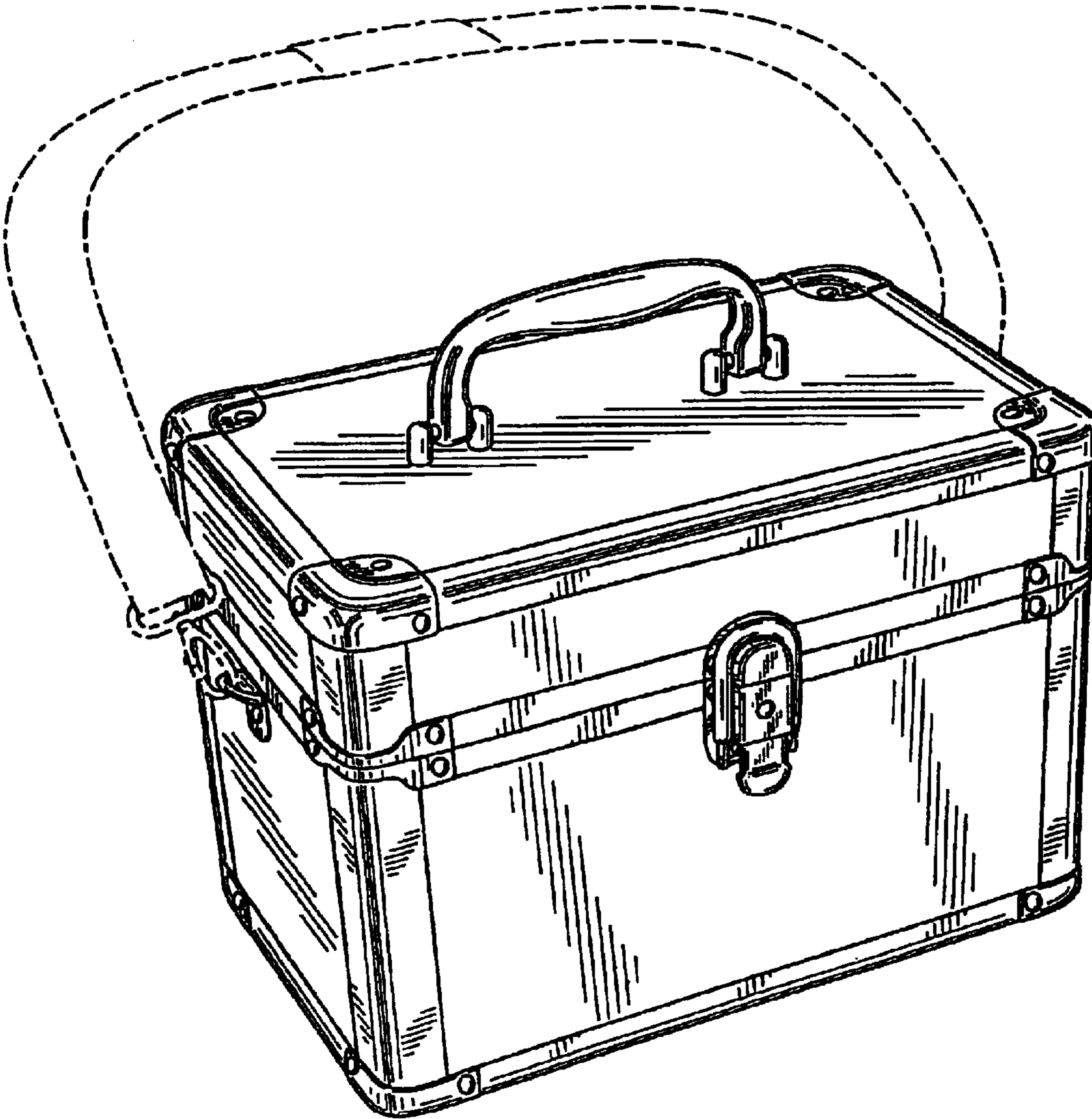

FIG. 6