

US00D509354S

(12) **United States Design Patent**
Tannenhauser

(10) **Patent No.:** **US D509,354 S**

(45) **Date of Patent:** **** Sep. 13, 2005**

(54) **BOTTLE HOLDER**

6,533,150 B1 3/2003 Margo et al. 224/250
D497,779 S * 11/2004 Giampavolo D7/620

(76) **Inventor:** **Michael Tannenhauser**, 420 E. 72 St.,
5A, New York, NY (US) 10021

* cited by examiner

(**) **Term:** **14 Years**

Primary Examiner—Catherine R. Oliver
(74) *Attorney, Agent, or Firm*—Nixon & Vanderhye P.C.

(21) **Appl. No.:** **29/205,176**

(57) **CLAIM**

(22) **Filed:** **May 11, 2004**

The ornamental design for a “bottle holder,” as shown and described.

(51) **LOC (8) Cl.** **03-01**

(52) **U.S. Cl.** **D3/229**

(58) **Field of Search** D3/229, 221, 215,
D3/224–228; D7/619.1, 620, 622; 220/737–740;
224/250, 148.6, 463; 248/311.2

DESCRIPTION

(56) **References Cited**

U.S. PATENT DOCUMENTS

4,951,910 A	8/1990	March	248/311.2
5,170,917 A	12/1992	Tourigny	224/221
D343,293 S	* 1/1994	Montgomery	D3/229
5,325,991 A	7/1994	Williams	220/739
D353,045 S	12/1994	Chandler	D3/229
5,456,432 A	10/1995	Ennis et al.	248/102
5,535,928 A	7/1996	Herring	224/250
5,622,346 A	4/1997	Story, Jr.	248/311.2
5,806,730 A	9/1998	Deno	224/148.6
D403,073 S	12/1998	Hrdlicka	D24/199
D408,991 S	5/1999	Perez	D3/229
5,941,434 A	* 8/1999	Green	224/250
D419,392 S	1/2000	Schlebusch	D7/619
6,032,841 A	3/2000	Johnson	224/463
6,318,689 B1	11/2001	Rodriguez	248/311.2
D453,095 S	* 1/2002	Bailey	D7/620
6,454,146 B2	9/2002	Alis	224/250
D468,014 S	* 12/2002	Girod	D7/620

FIG. 1 is a perspective view of a bottle holder in accordance with my new design;
 FIG. 2 is a front elevation thereof;
 FIG. 3 is a right side elevation, the left side elevation being a mirror image thereof;
 FIG. 4 is a top plan view thereof;
 FIG. 5 is a bottom plan view thereof;
 FIG. 6 is a rear elevation thereof;
 FIG. 7 is a perspective view of a bottle holder in accordance with a second embodiment;
 FIG. 8 is a front elevation thereof;
 FIG. 9 is a right side elevation, the left side elevation being a mirror image thereof;
 FIG. 10 is a top plan view thereof;
 FIG. 11 is a bottom plan view thereof;
 FIG. 12 is a rear elevation thereof; and,
 FIG. 13 is a perspective view of the bottle holder shown in FIGS. 1–6 with dotted lines illustrating the intended use and environment of the design.
 The broken line showing of a rear clip is for illustrative purposes only and forms no part of the claimed design.

1 Claim, 11 Drawing Sheets

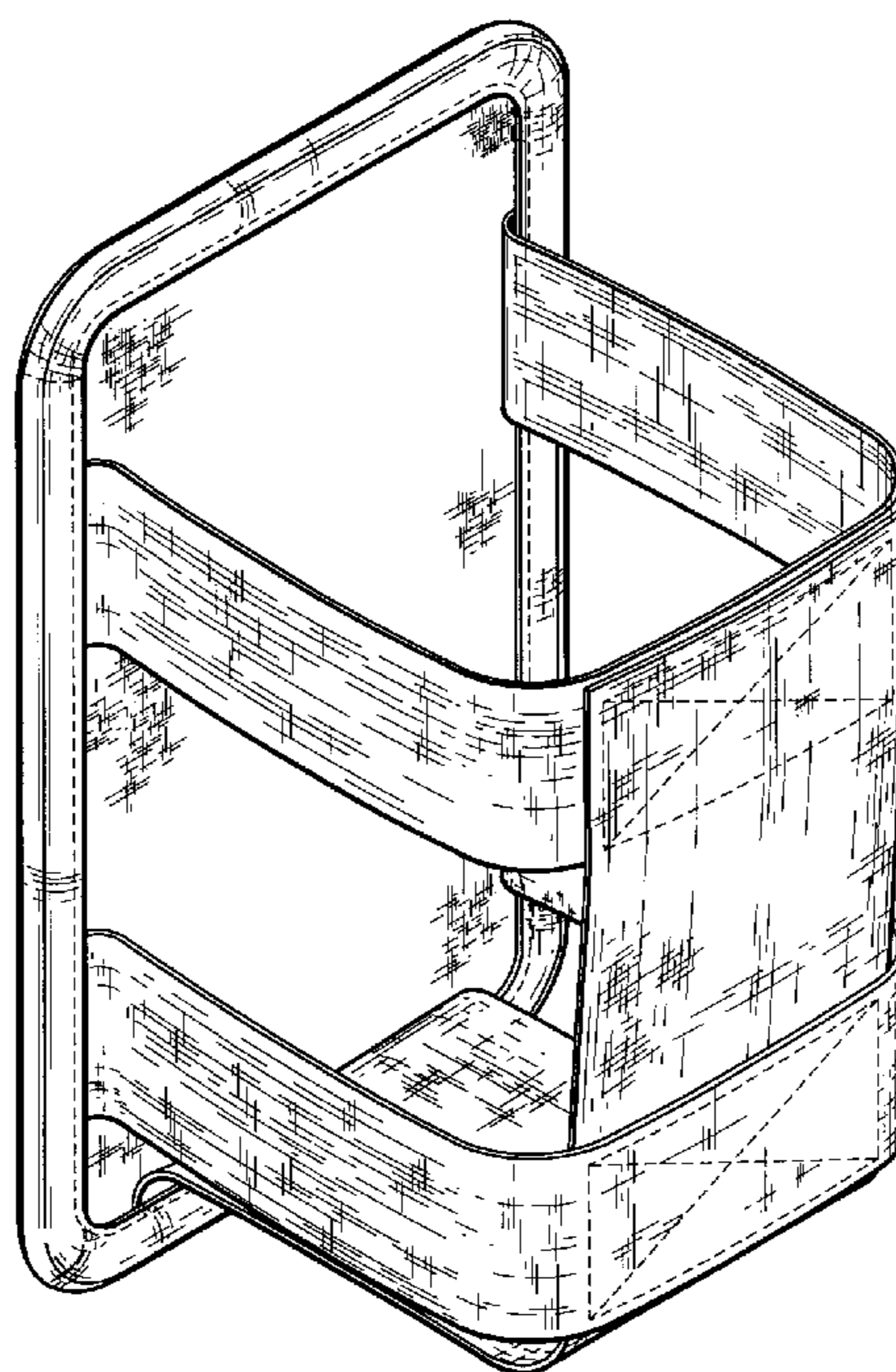

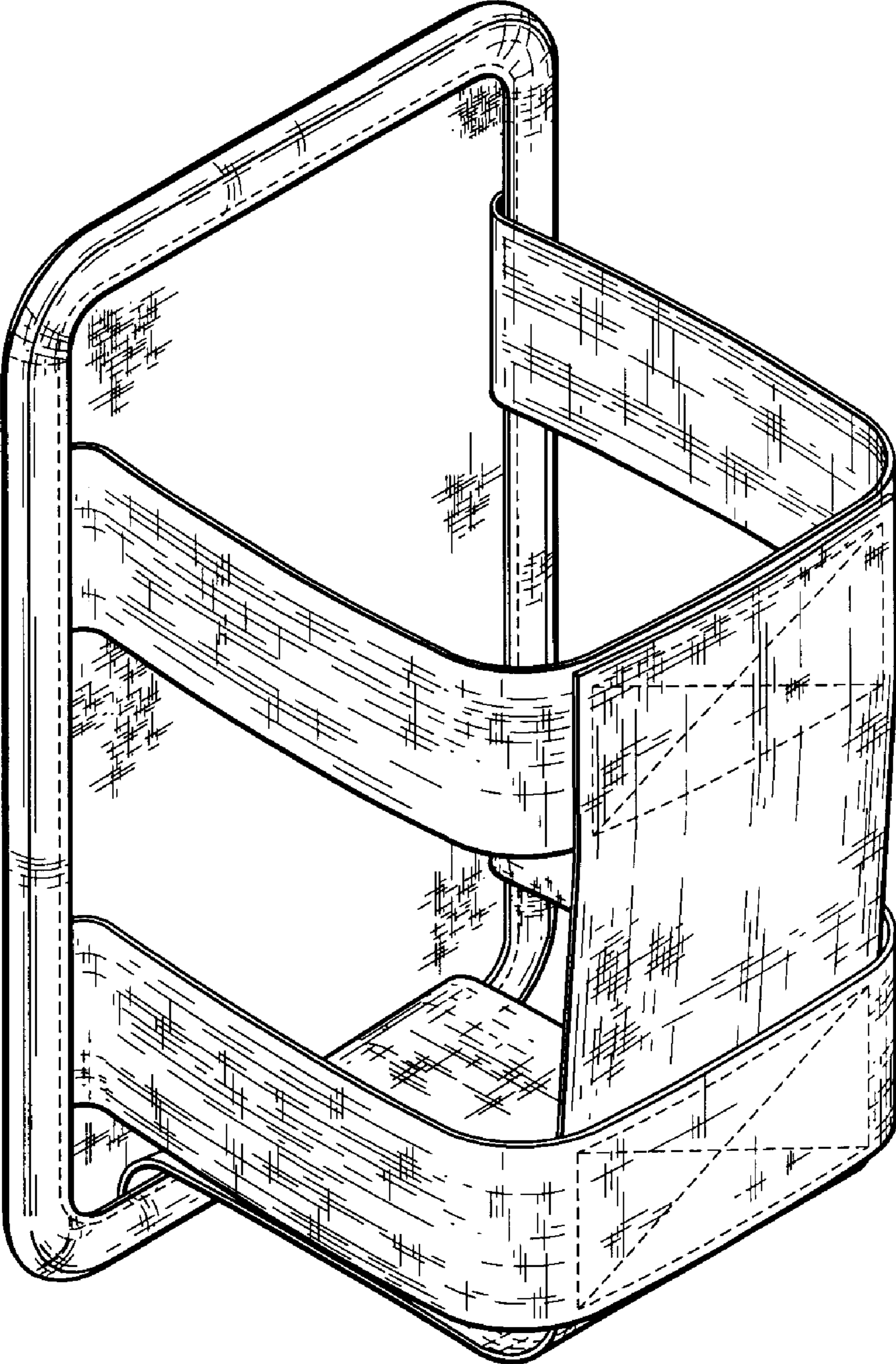

Fig. 1

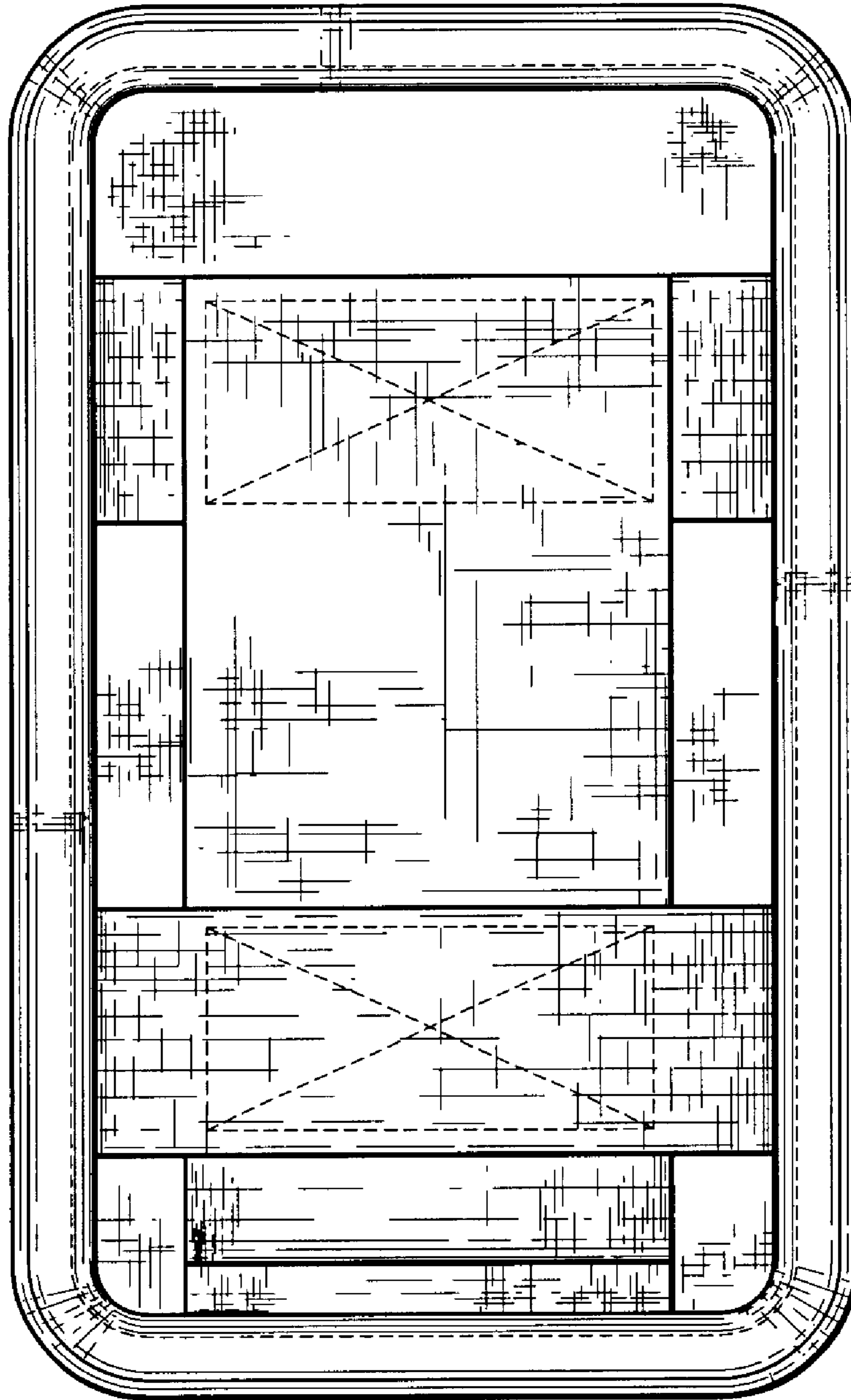

Fig. 2

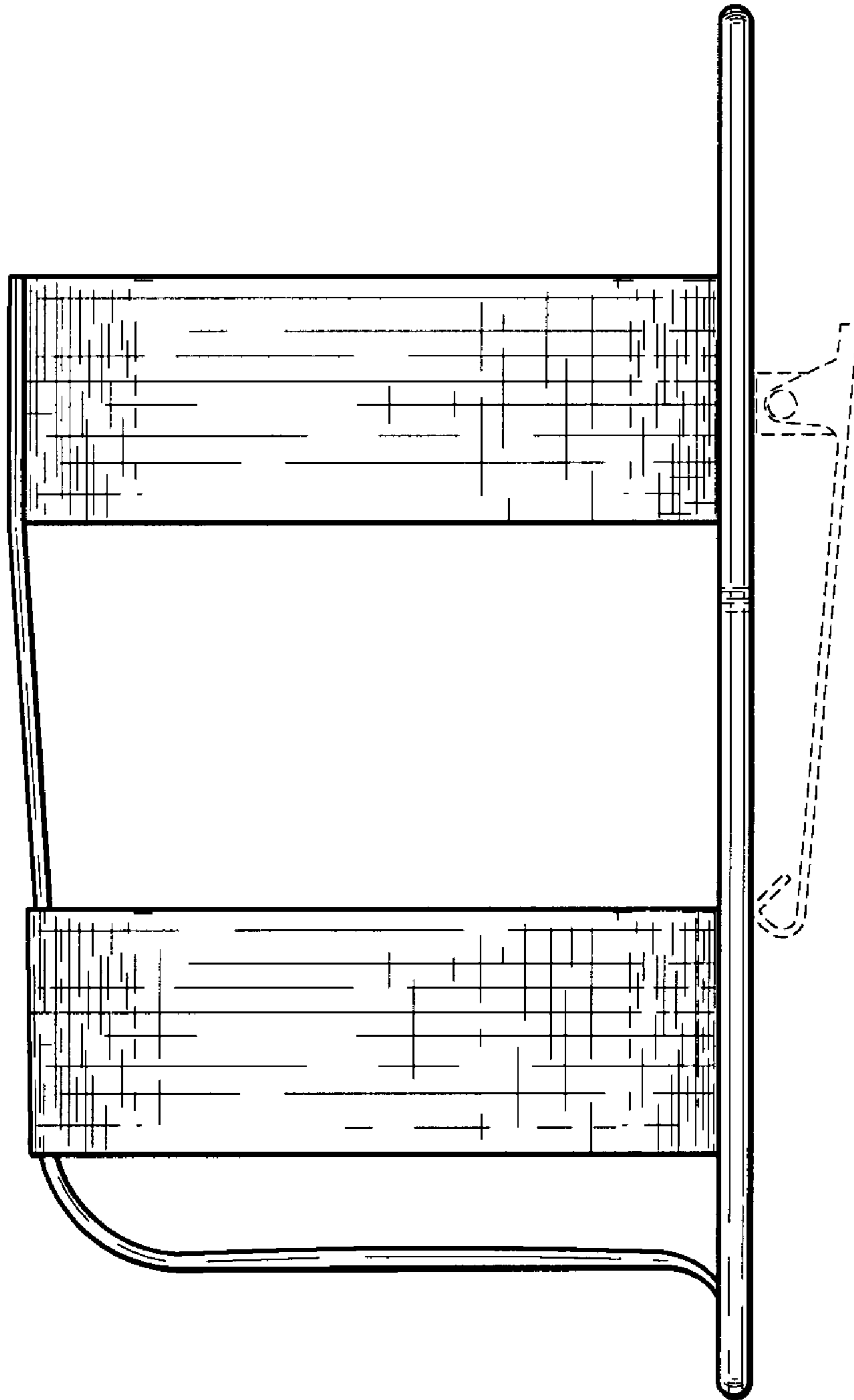

Fig. 3

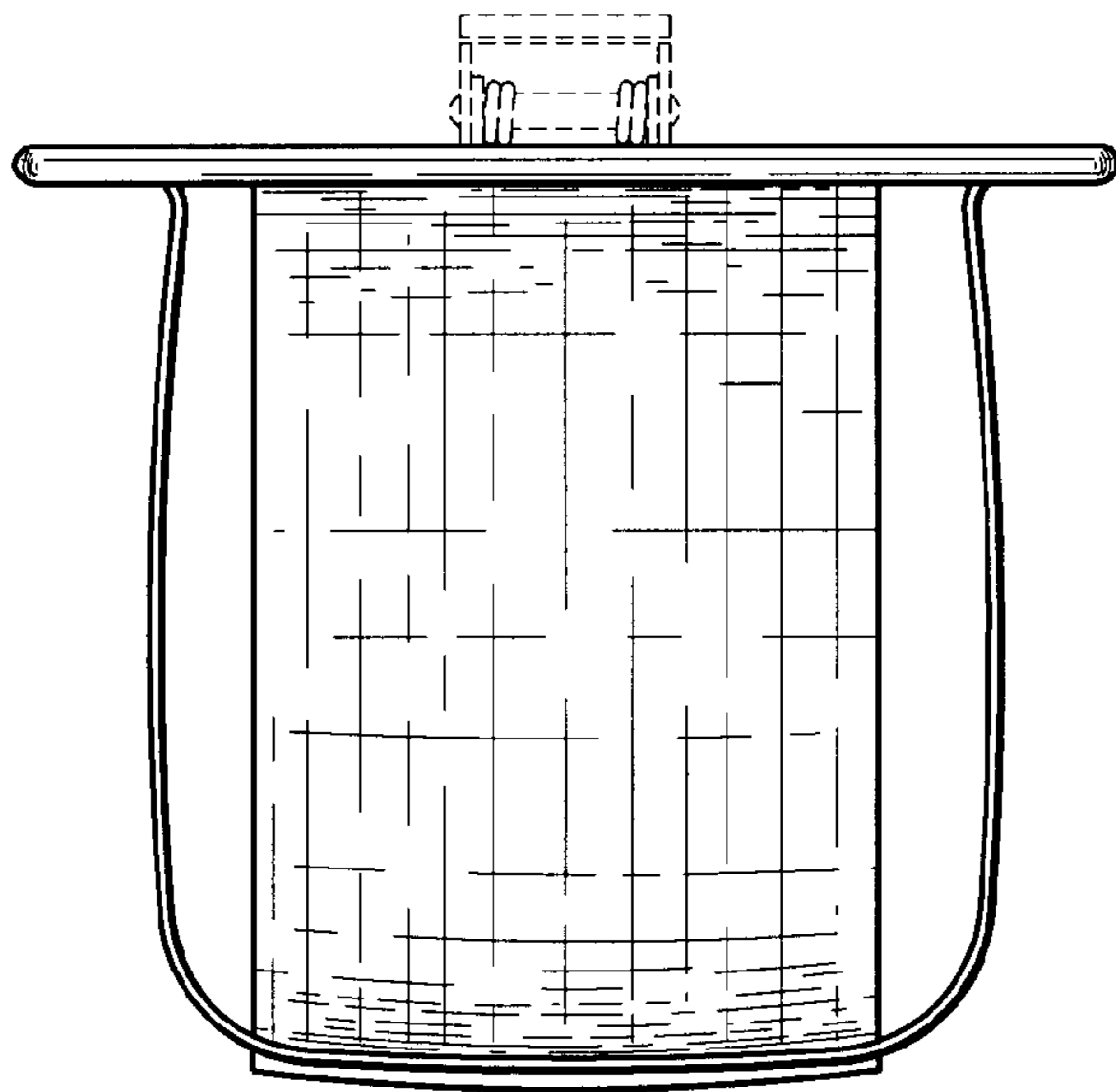

Fig. 4

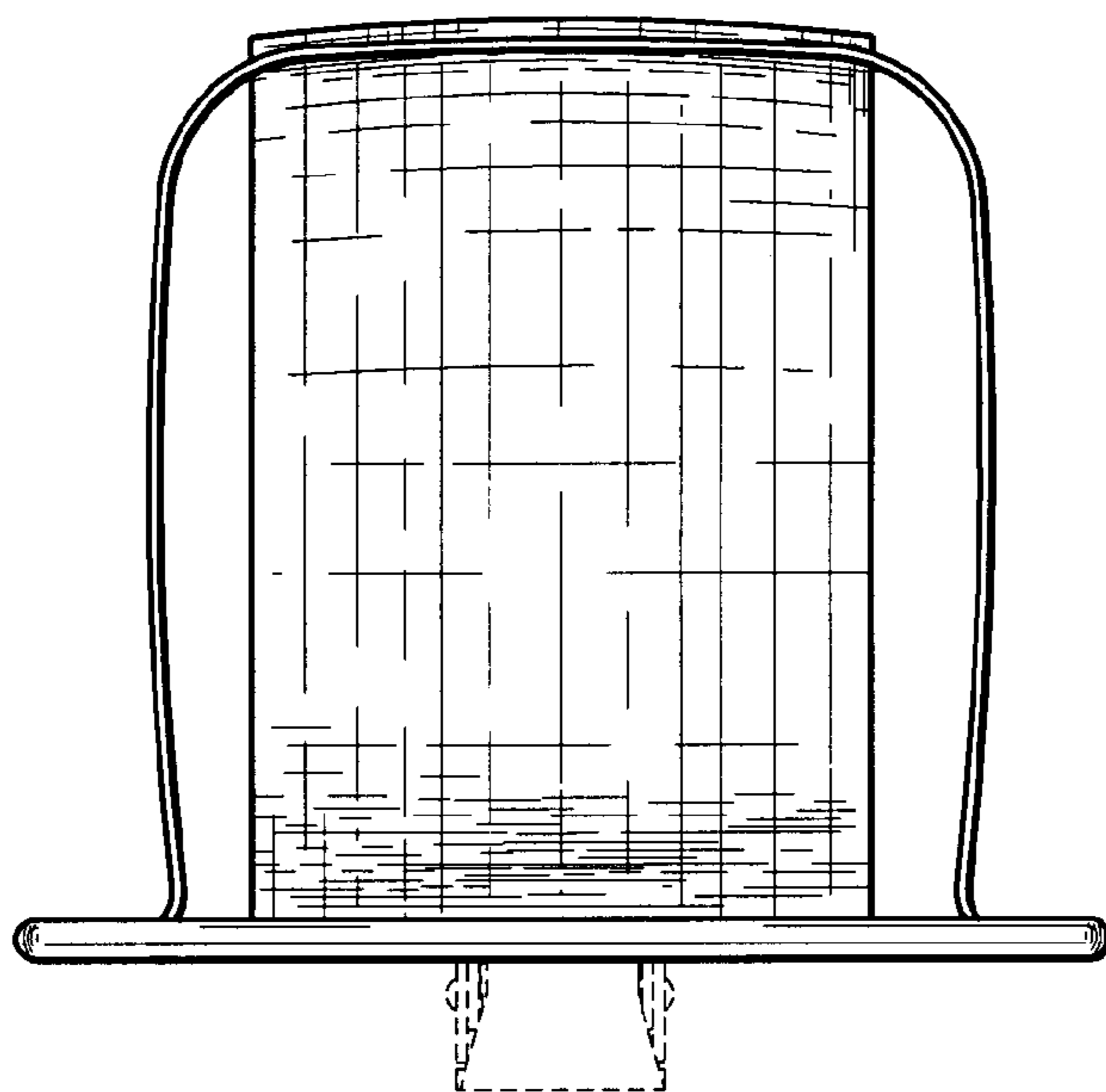

Fig. 5

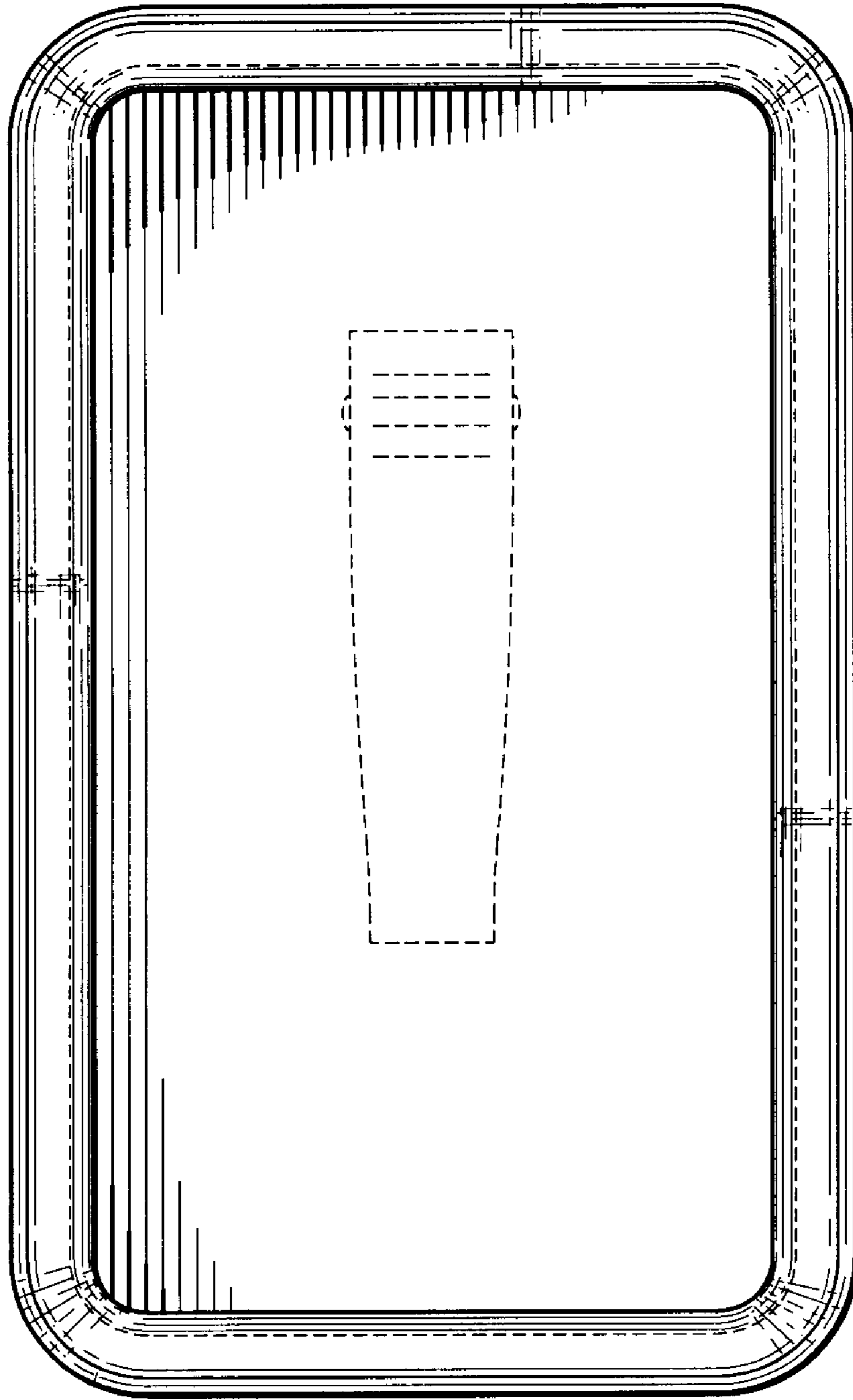

Fig. 6

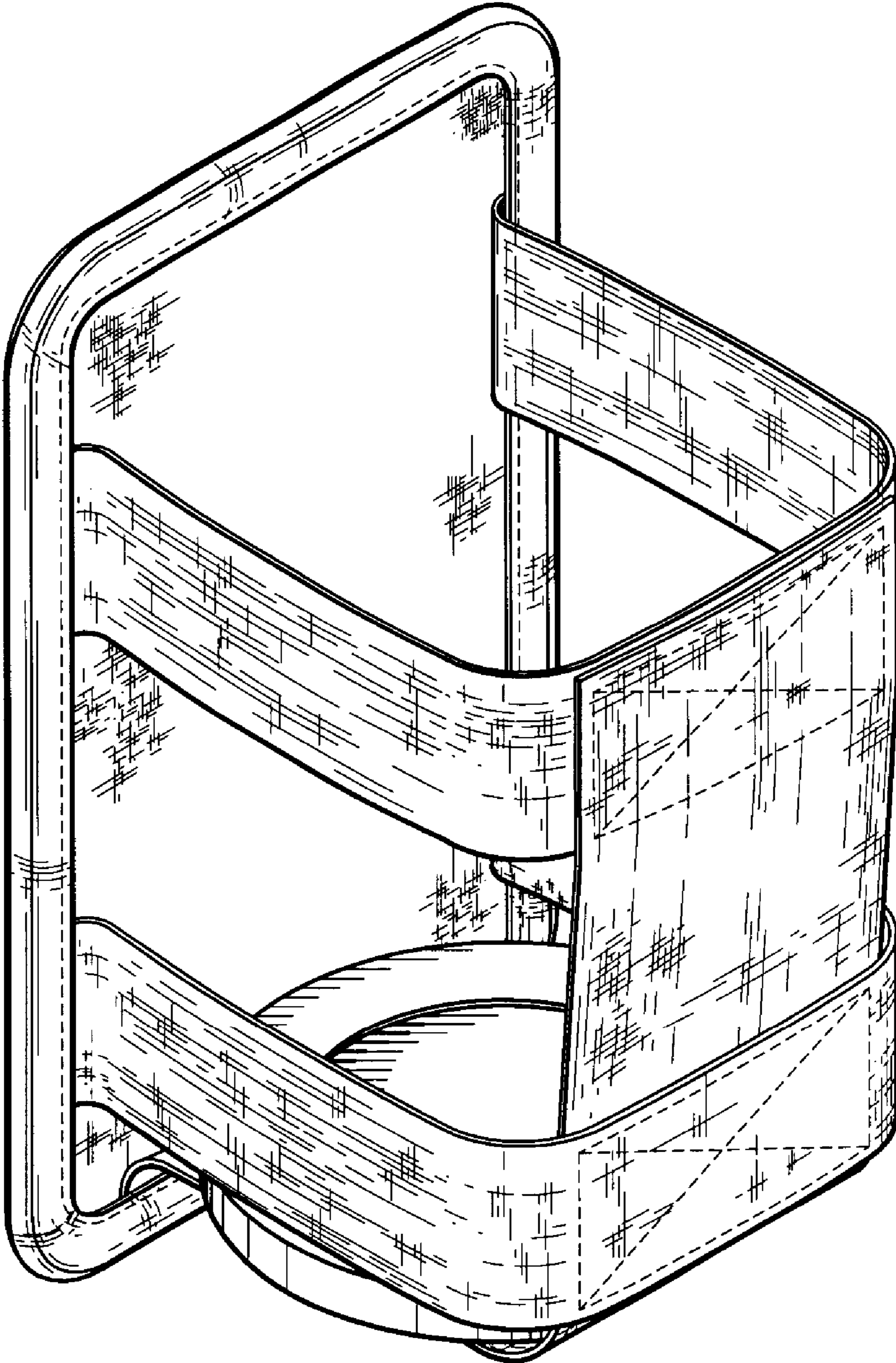

Fig. 7

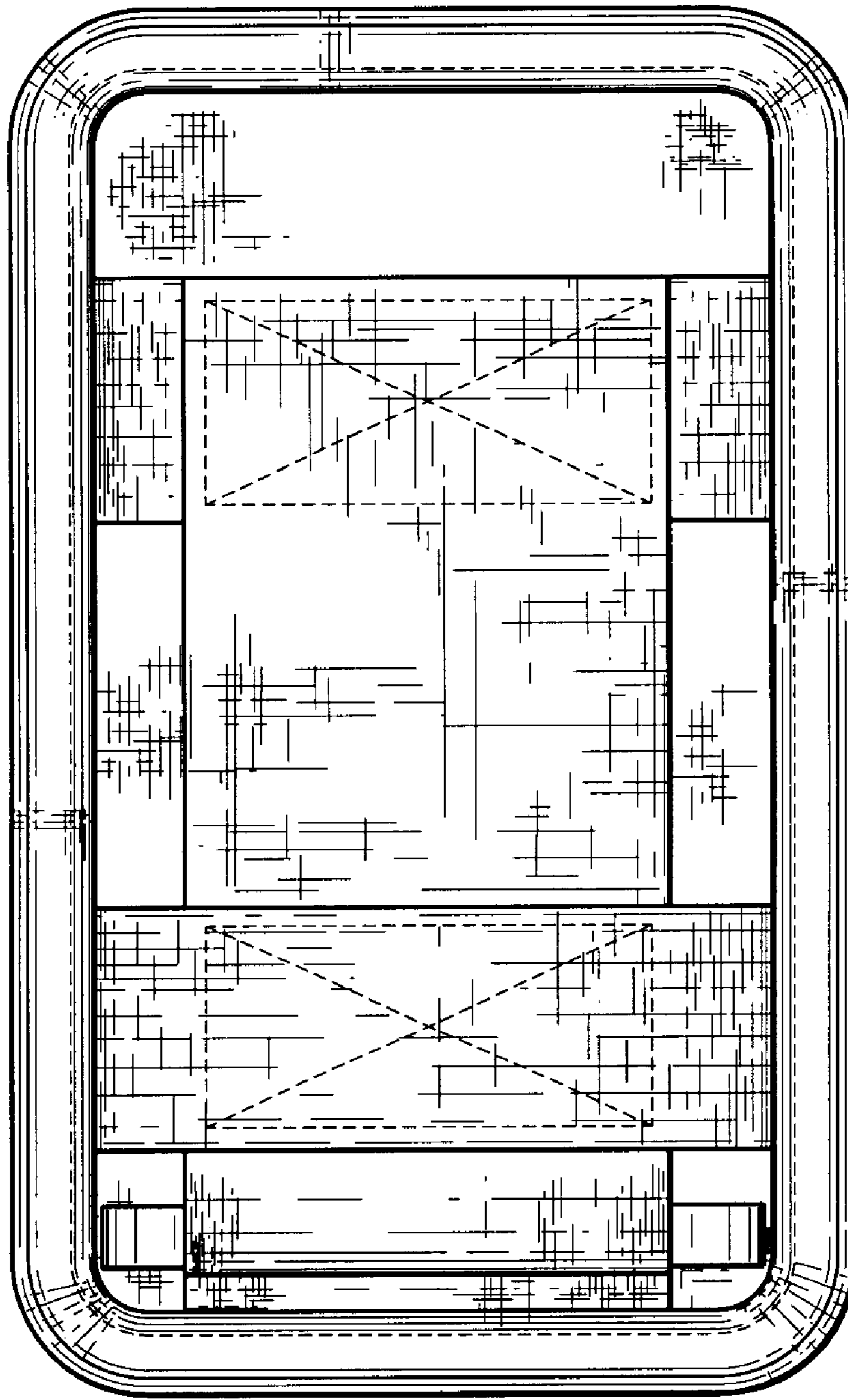

Fig. 8

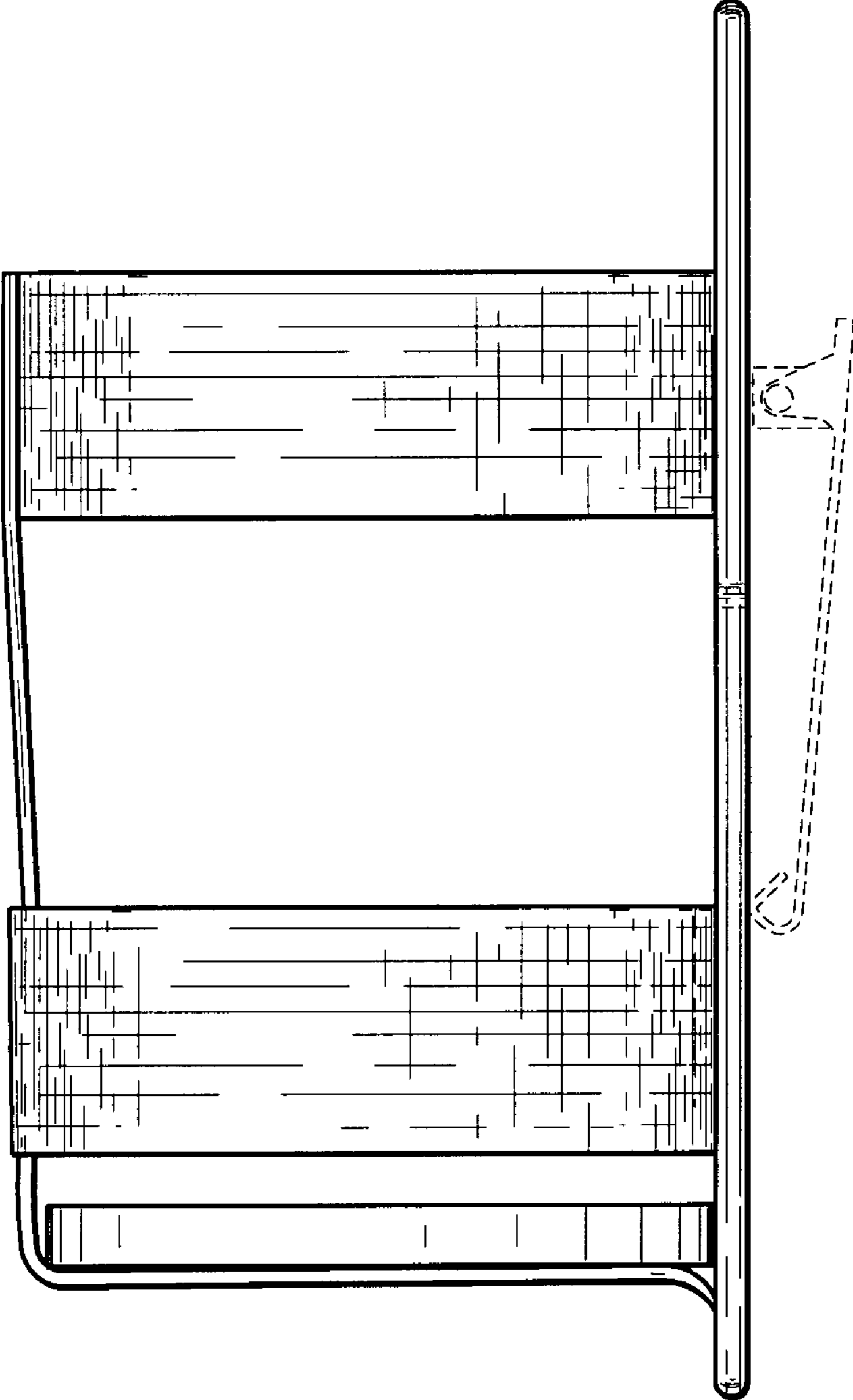

Fig. 9

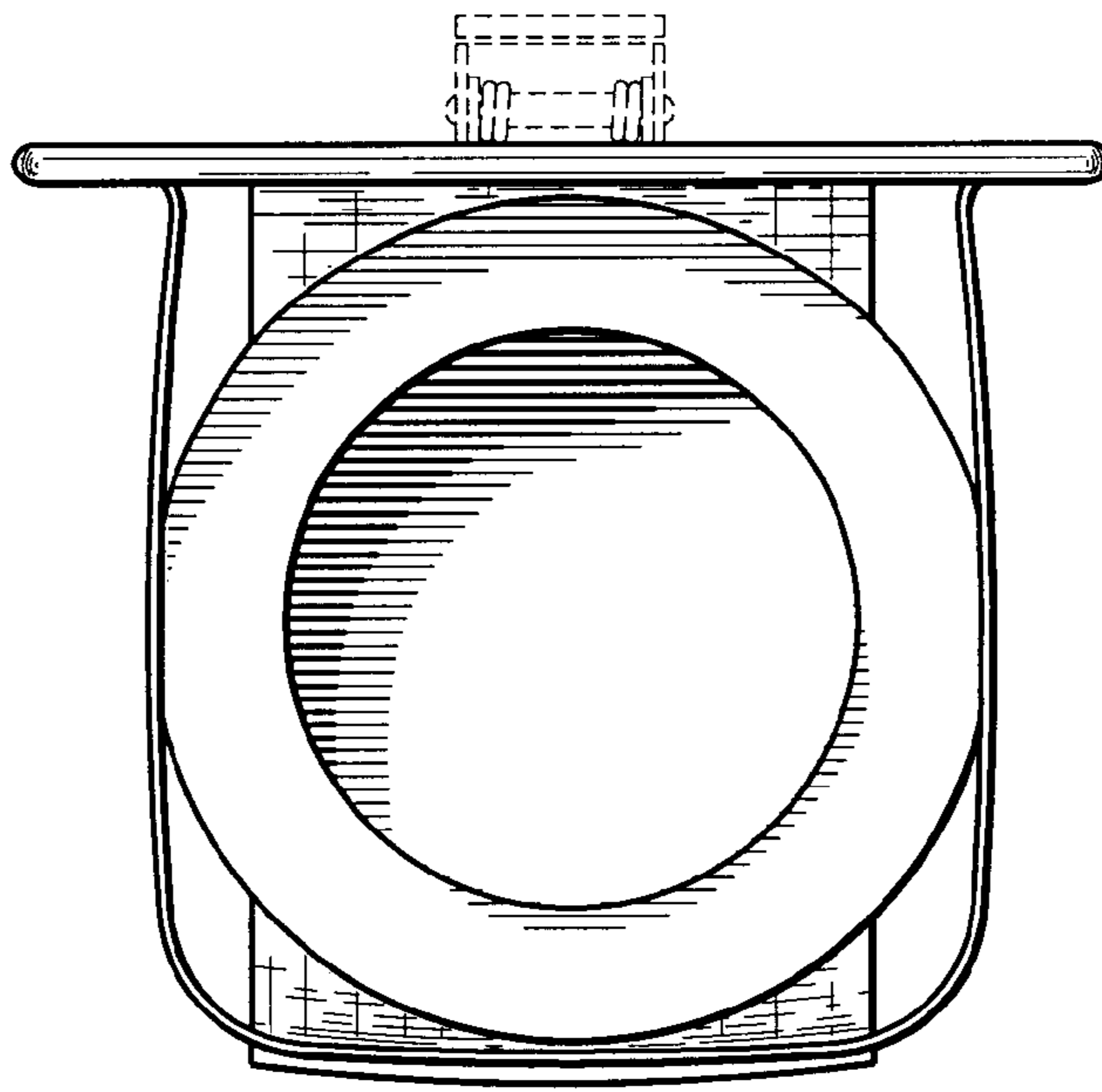

Fig. 10

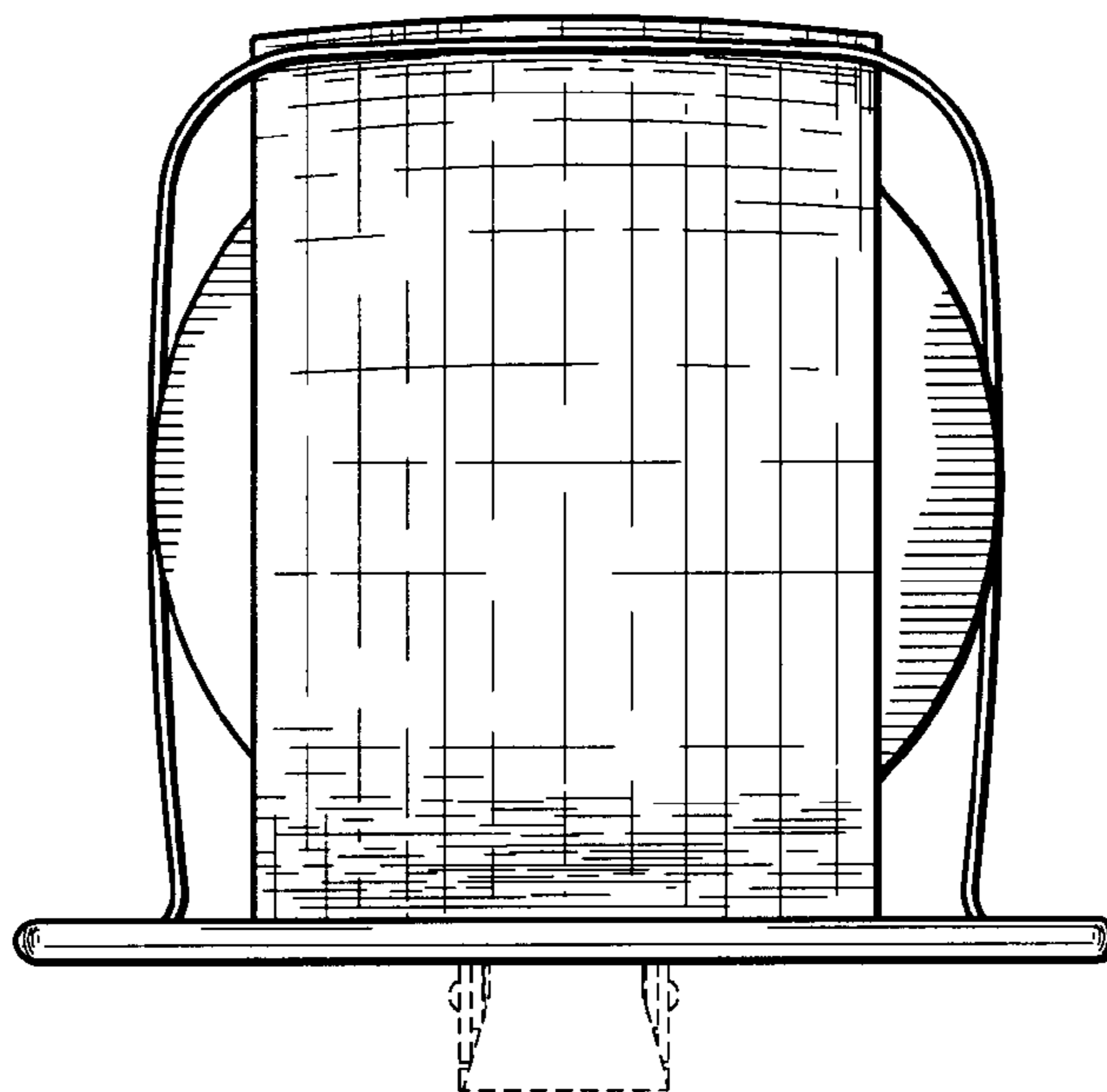

Fig. 11

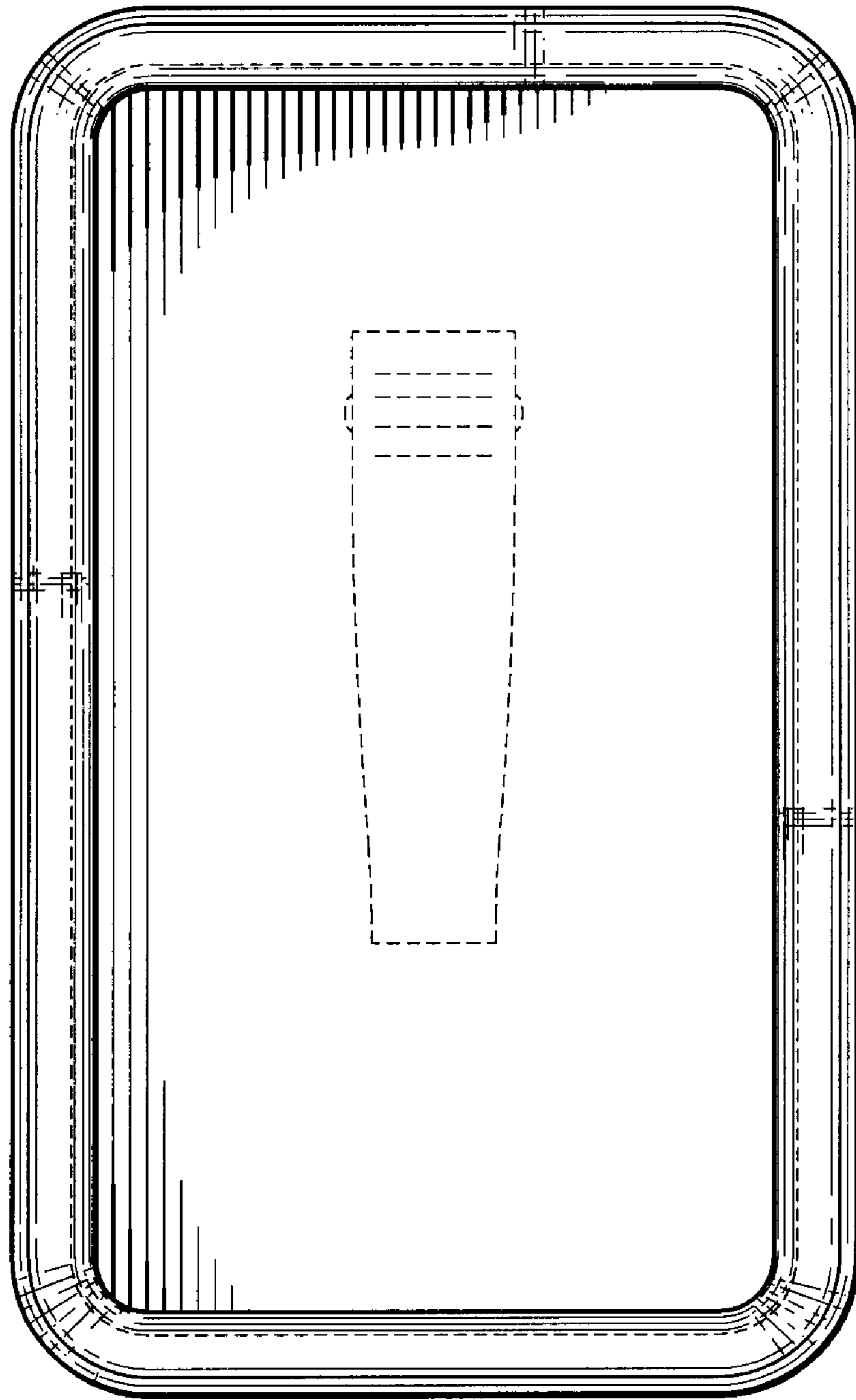

Fig. 12

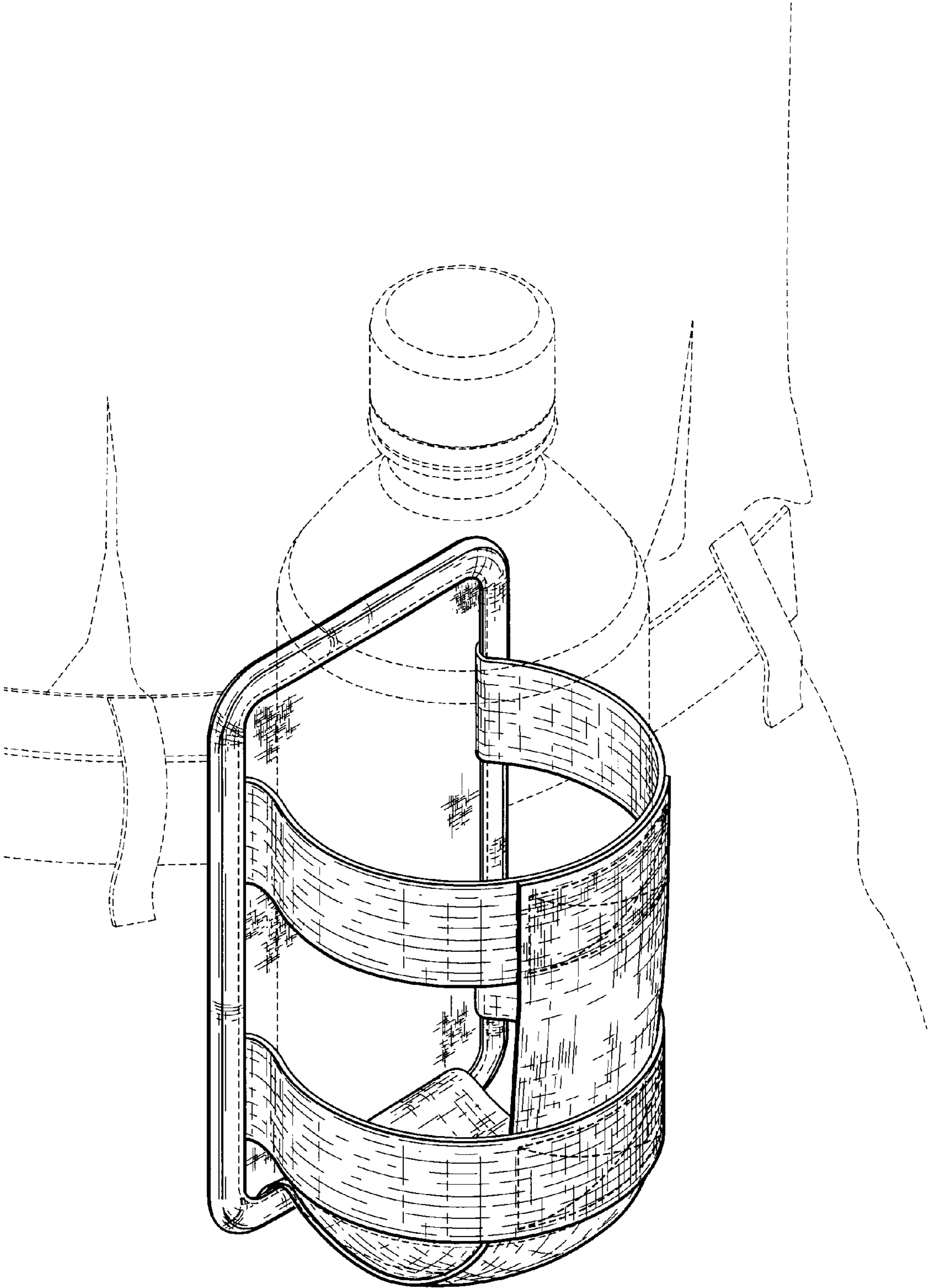

Fig. 13