



US00D509200S

(12) **United States Design Patent**
Harris

(10) **Patent No.:** **US D509,200 S**
(45) **Date of Patent:** **** Sep. 6, 2005**

(54) **SINGLE UNIT COMFORTABLE WIRELESS COMMUNICATION DEVICE**

(75) Inventor: **Arlene Joy Harris**, Del Mar, CA (US)

(73) Assignee: **Dyna LLC**, Del Mar, CA (US)

(**) Term: **14 Years**

(21) Appl. No.: **29/205,217**

(22) Filed: **May 10, 2004**

(51) **LOC (8) Cl.** **14-03**

(52) **U.S. Cl.** **D14/138**

(58) **Field of Search** D14/137, 138,
D14/147-148, 247-248, 144, 143, 341-347,
205, 206, 223; 379/433.01-433.13, 434,
430; 455/550.1-90.3, 575.3, 566, 575.1,
575.4, 575.6, 556.1, 556.2; D21/517; 345/169

(56) **References Cited**

U.S. PATENT DOCUMENTS

D291,991 S	*	9/1987	Lee	D14/147
D292,400 S	*	10/1987	Boggs et al.	D14/147
D327,888 S	*	7/1992	Fitzgerald	D14/147
5,197,091 A	*	3/1993	Takagi et al.	455/575.7
D350,744 S	*	9/1994	Hino	D14/138
D355,917 S	*	2/1995	Grewe et al.	D14/248
D369,796 S	*	5/1996	Grewe	D14/138
D371,126 S	*	6/1996	Bro	D14/138
D373,127 S	*	8/1996	Godee et al.	D14/248
5,715,311 A	*	2/1998	Sudo et al.	379/433.01
D394,436 S	*	5/1998	Hall et al.	D14/206
5,749,057 A	*	5/1998	Takagi	455/569.2
5,751,825 A	*	5/1998	Myers et al.	381/118
5,940,503 A	*	8/1999	Palett et al.	379/454
D415,150 S	*	10/1999	Hasegawa et al.	D14/138
5,982,883 A	*	11/1999	Alix et al.	379/433.12
6,052,464 A	*	4/2000	Harris et al.	379/433.07
D424,558 S	*	5/2000	Hong	D14/143
D427,172 S	*	6/2000	Bequir	D14/138
6,101,402 A	*	8/2000	Bartha et al.	455/569.1
6,137,883 A	*	10/2000	Kaschke et al.	379/433.07

D433,671 S	*	11/2000	Fitzgerald	D14/142
D434,403 S	*	11/2000	Jaynes et al.	D14/138
6,192,221 B1	*	2/2001	Hasegawa	455/575.3
D444,135 S	*	6/2001	Park	D14/148
D451,078 S	*	11/2001	Kim	D14/138
D457,508 S	*	5/2002	Lam	D14/147
D460,429 S	*	7/2002	Kolwaite	D14/138
D460,953 S	*	7/2002	Argle et al.	D14/138
D490,787 S	*	6/2004	Aisenberg	D14/138
D495,675 S	*	9/2004	Nuovo et al.	D14/144
2003/0122784 A1	*	7/2003	Shkolnikov	345/169

* cited by examiner

Primary Examiner—Jeffrey Asch

(74) *Attorney, Agent, or Firm*—Paul, Hastings, Janofsky & Walker LLP

(57) **CLAIM**

The ornamental design for a single unit comfortable wireless communication device, as shown and described.

DESCRIPTION

FIG. 1 is a perspective view of a design for a single unit comfortable wireless communication device in accordance with a first embodiment;
 FIG. 2 is a top plan view thereof;
 FIG. 3 is a bottom plan view thereof;
 FIG. 4 is a right side elevational view thereof;
 FIG. 5 is a left side elevational view thereof;
 FIG. 6 is a front elevational view thereof;
 FIG. 7 is a rear elevational view thereof;
 FIG. 8 is a perspective view of a design for a single unit comfortable wireless communication device in accordance with a second embodiment;
 FIG. 9 is a top plan view thereof;
 FIG. 10 is a bottom plan view thereof;
 FIG. 11 is a right side elevational view thereof;
 FIG. 12 is a left side elevational view thereof;
 FIG. 13 is a front elevational view thereof; and,
 FIG. 14 is a rear elevational view thereof.

1 Claim, 6 Drawing Sheets

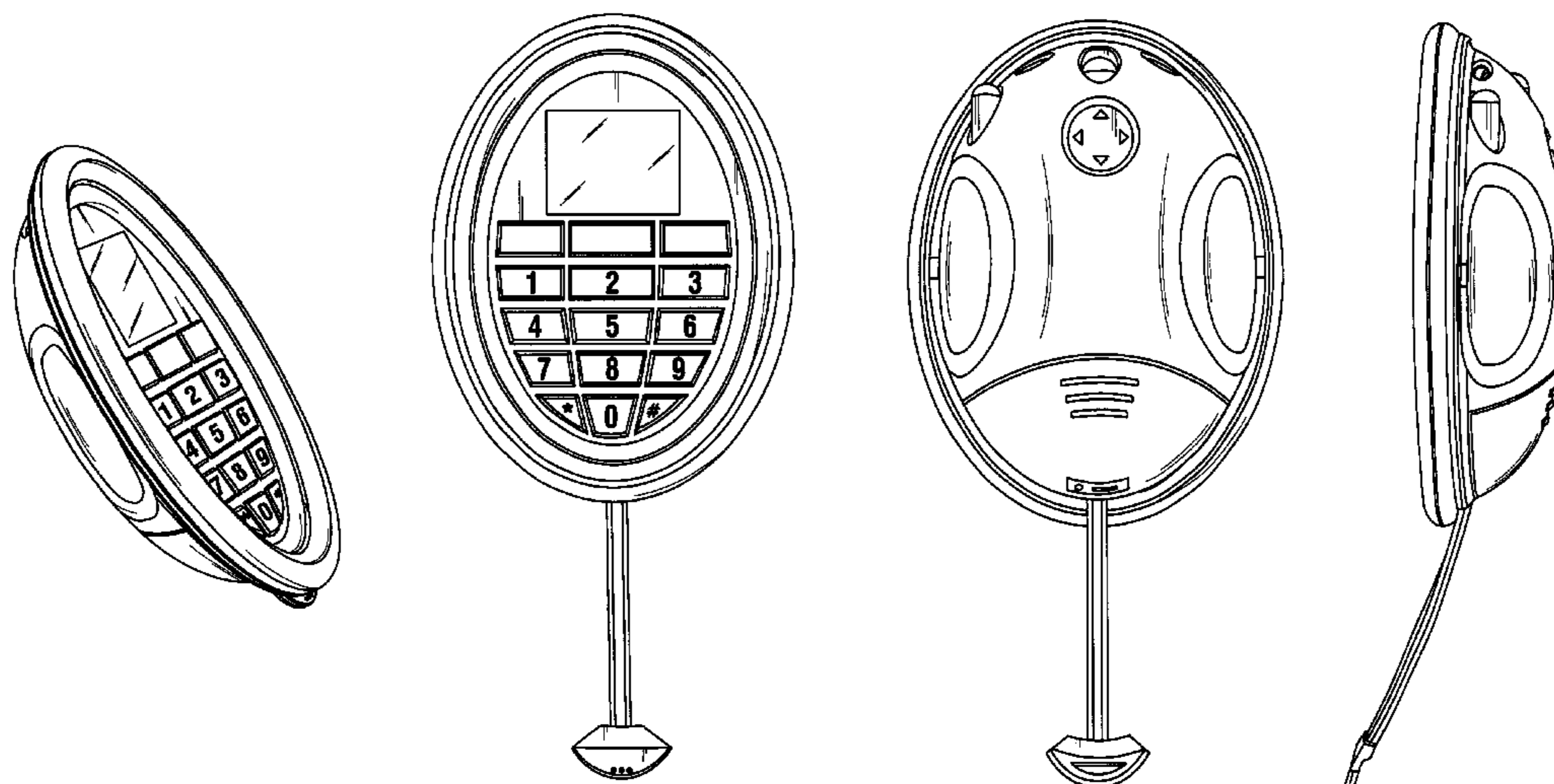

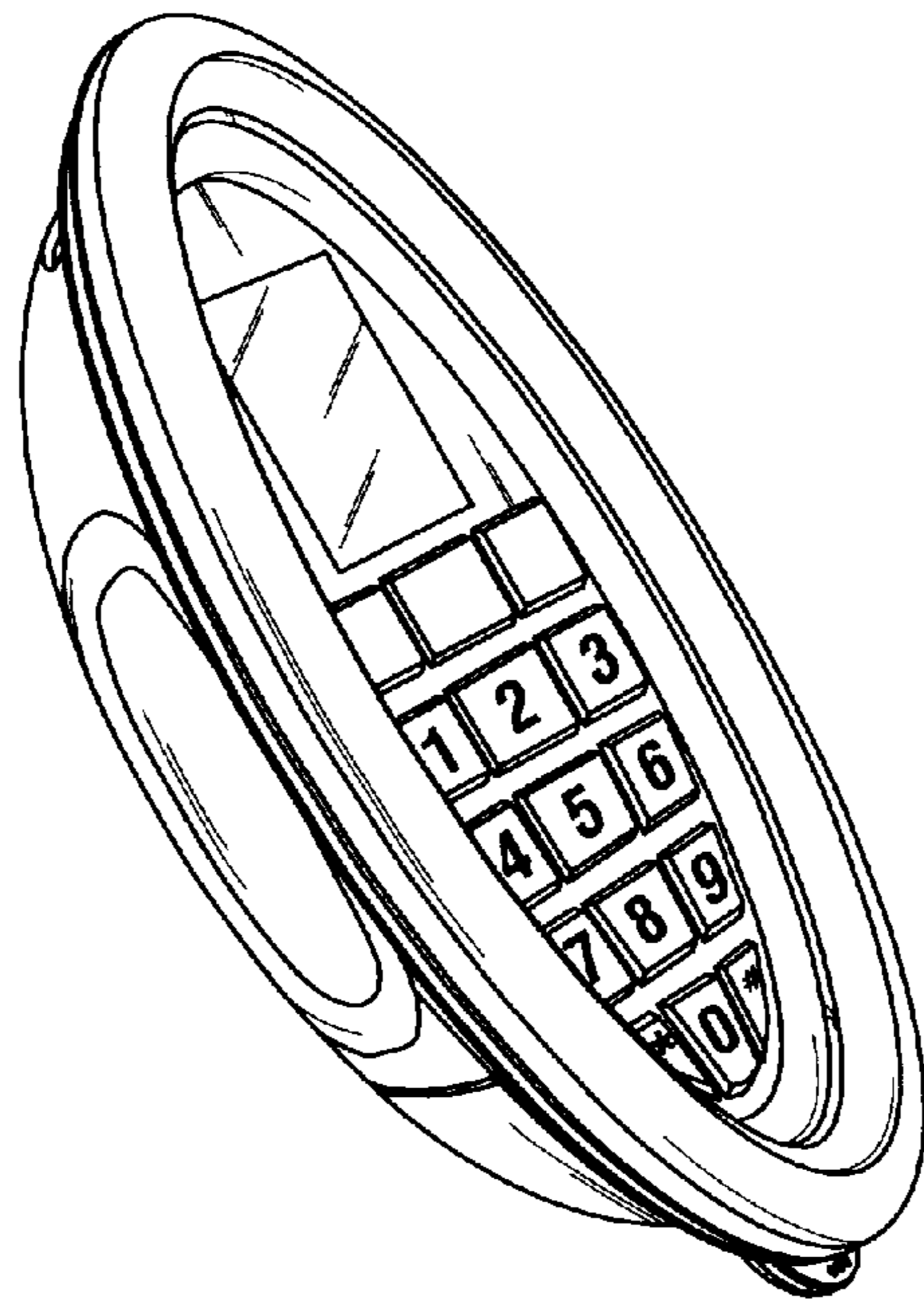

FIG. 1

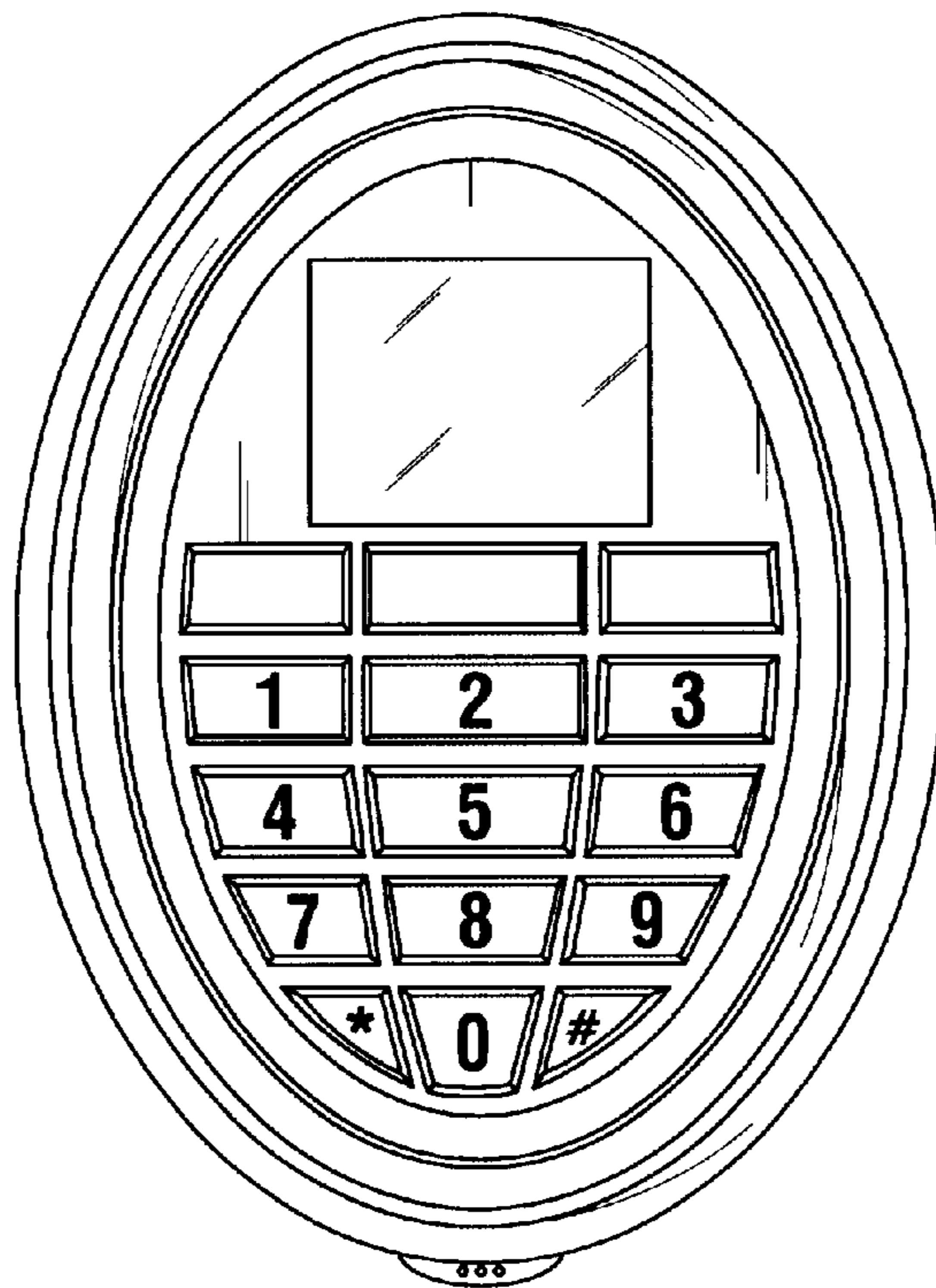

FIG. 2

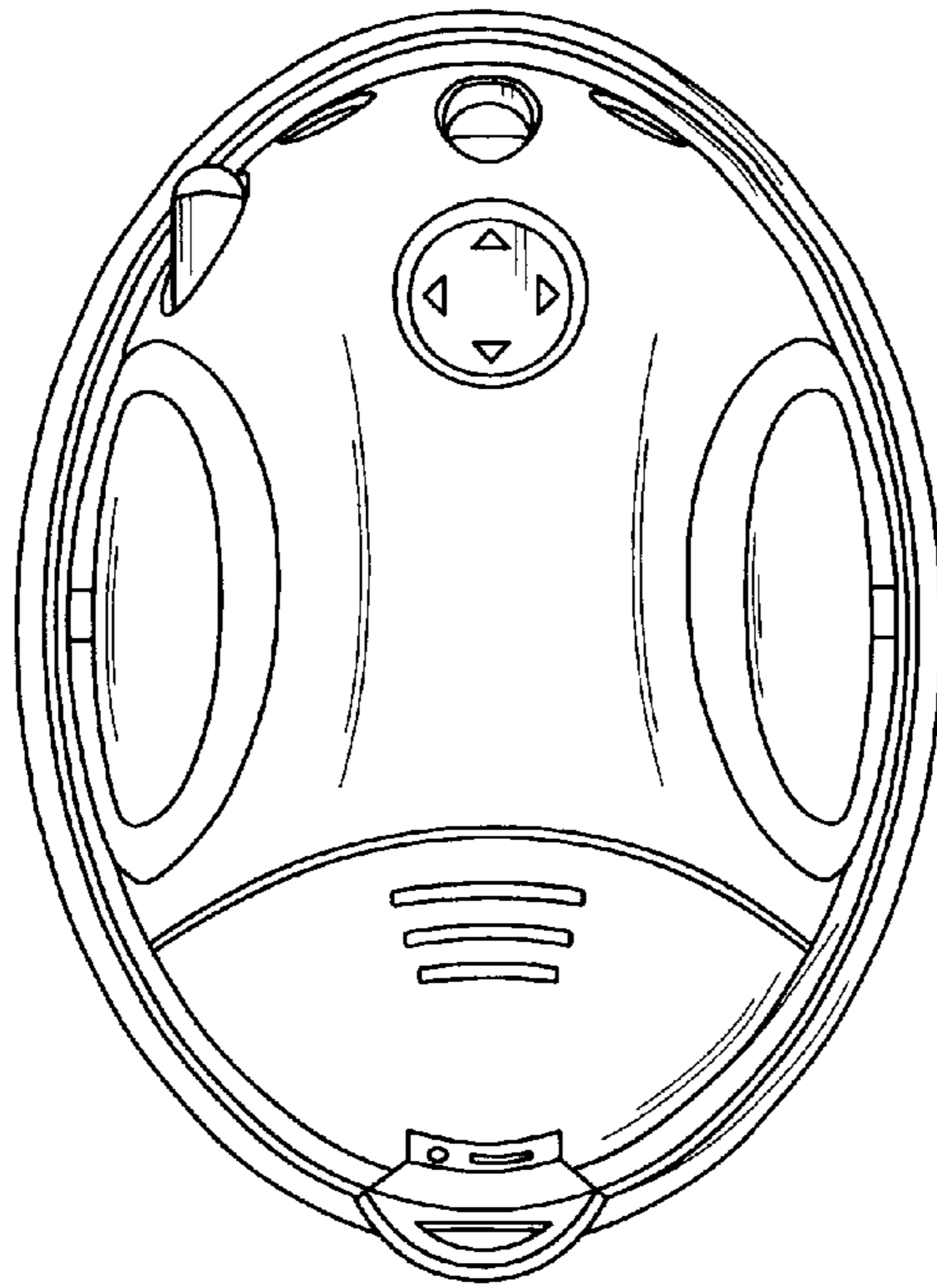

FIG. 3

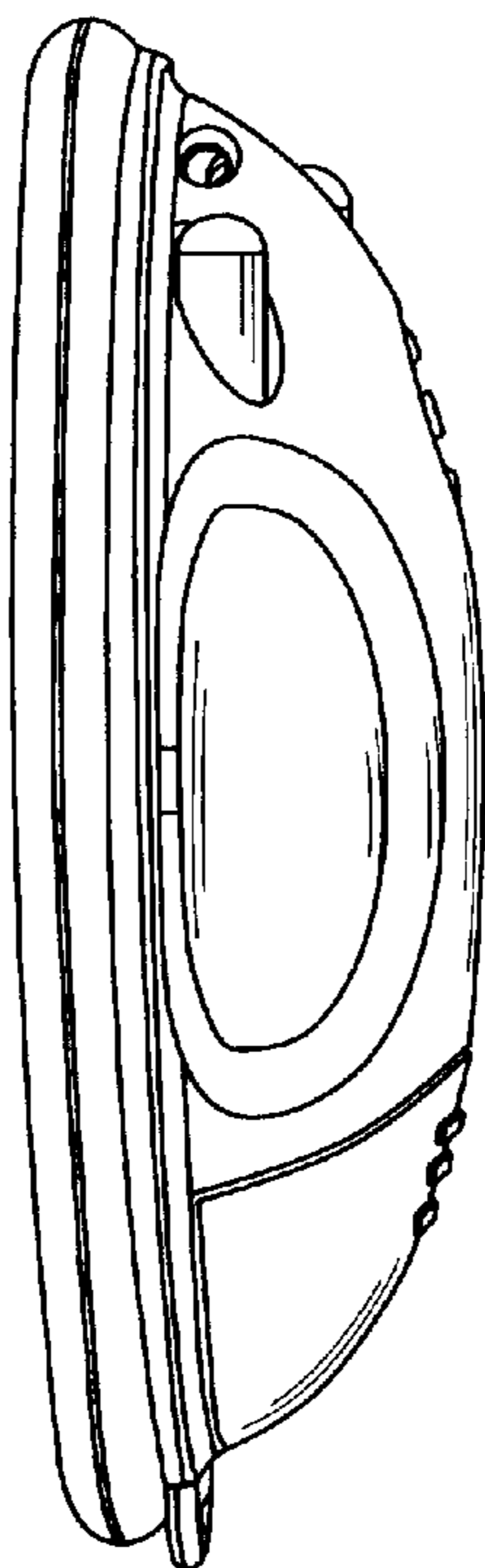

FIG. 4

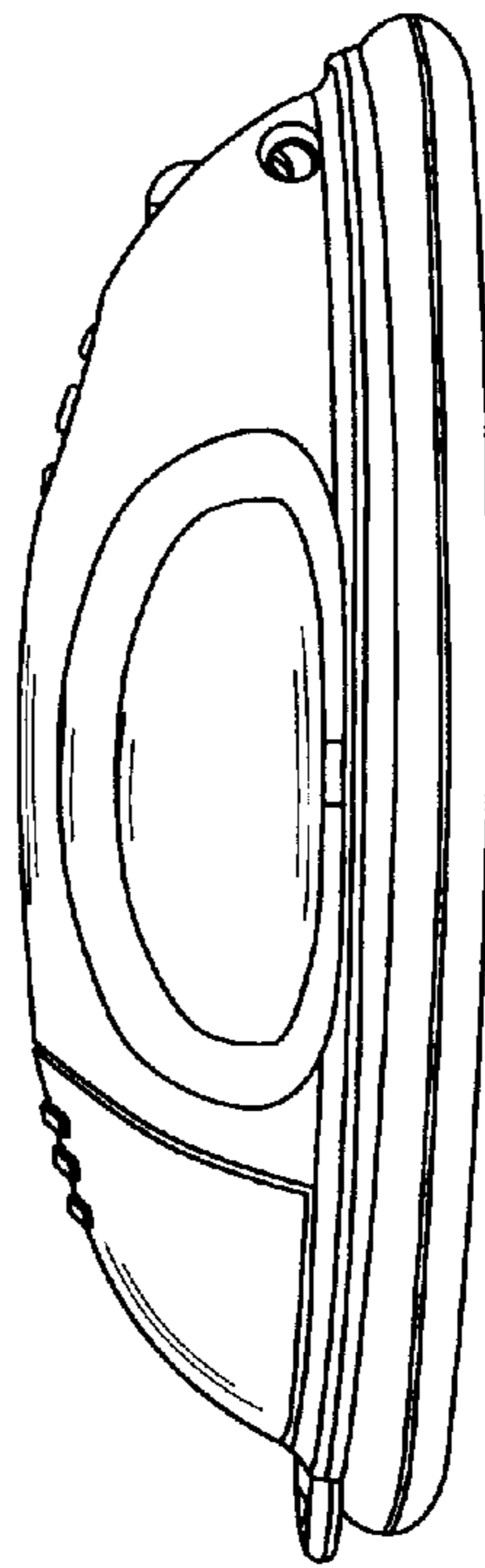

FIG. 5

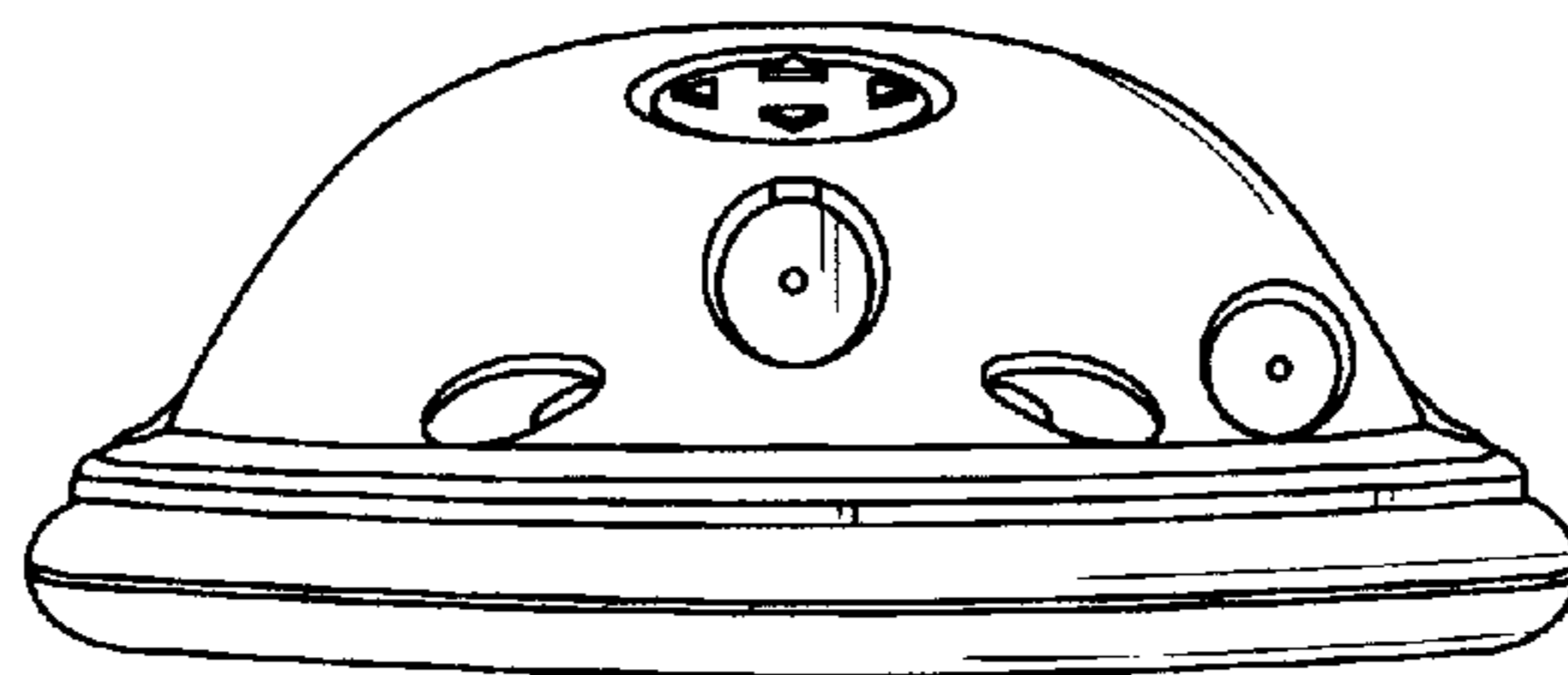

FIG. 6

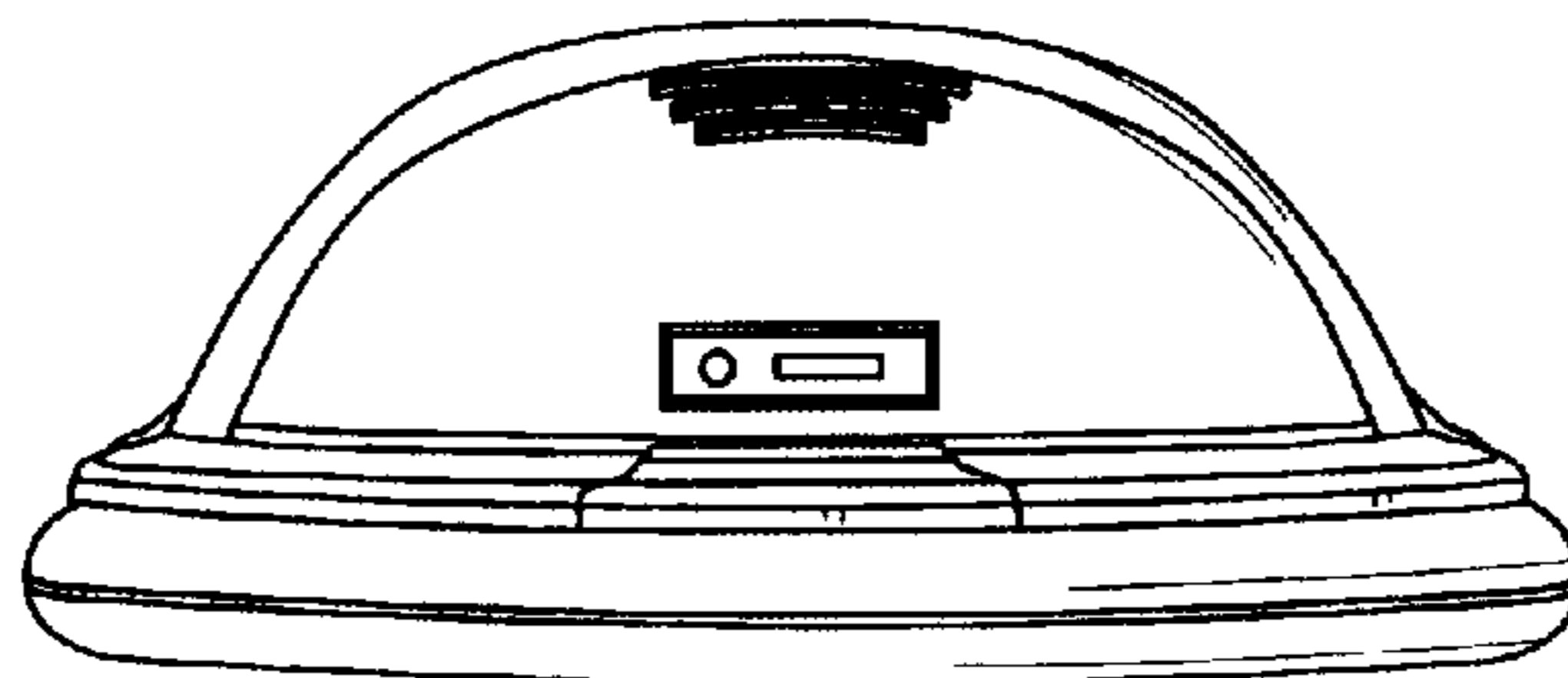

FIG. 7

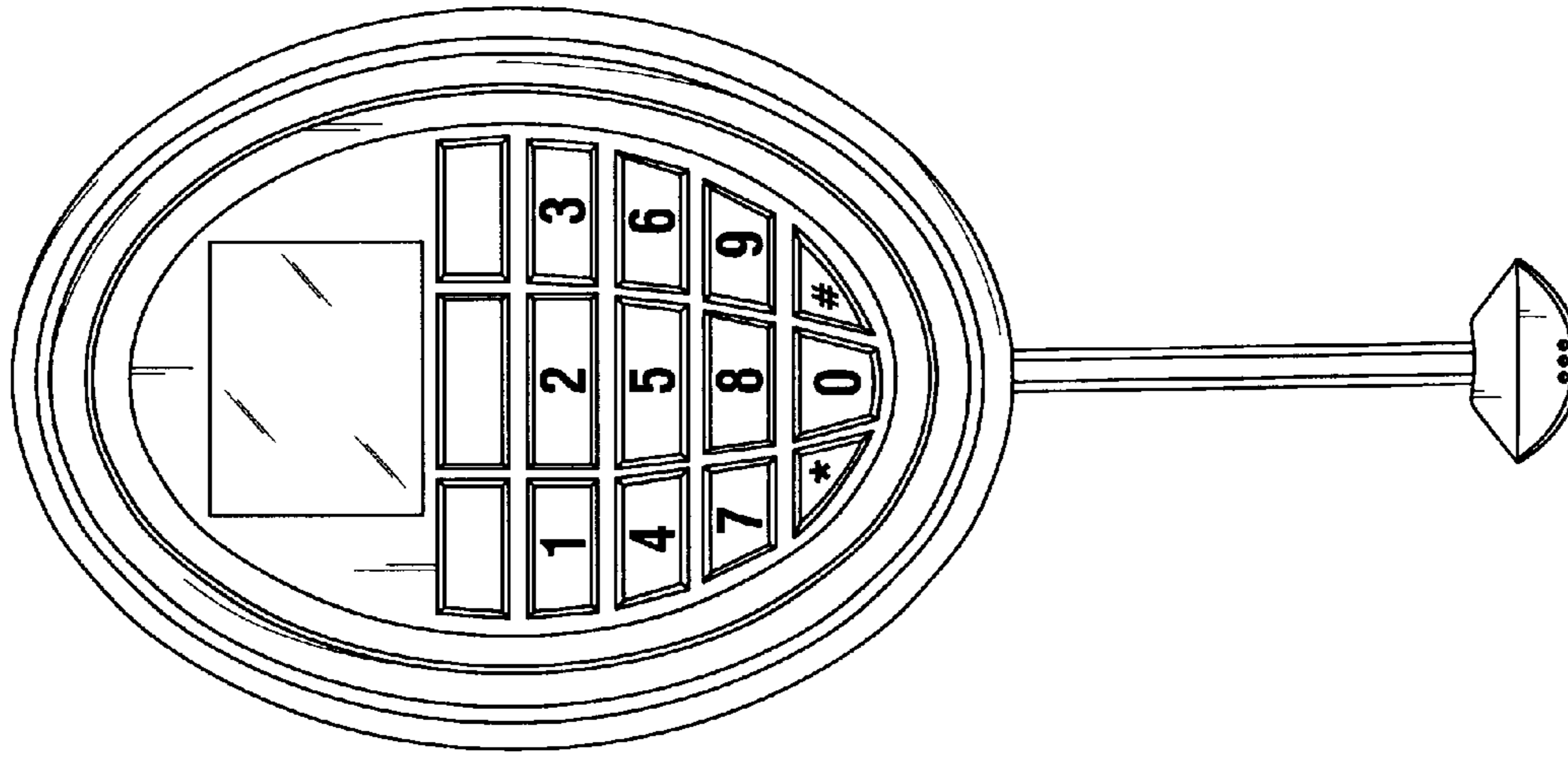

FIG. 9

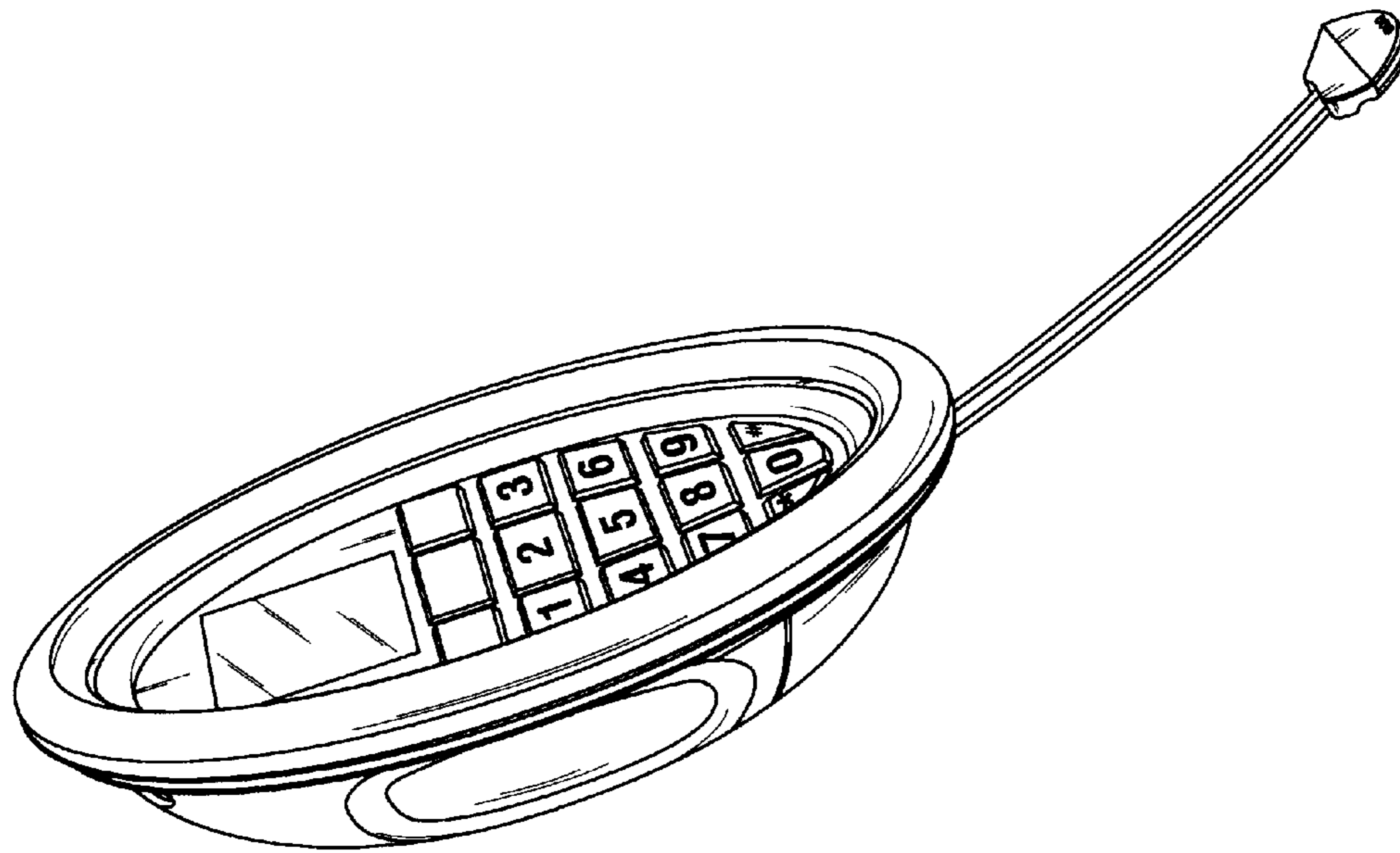

FIG. 8

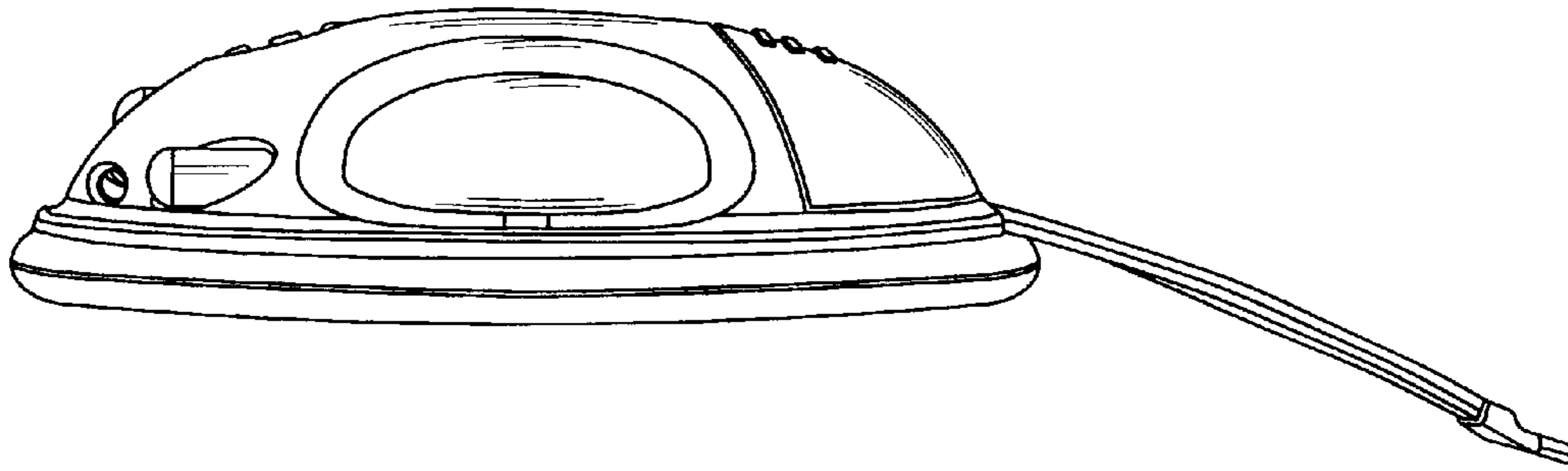

FIG. 11

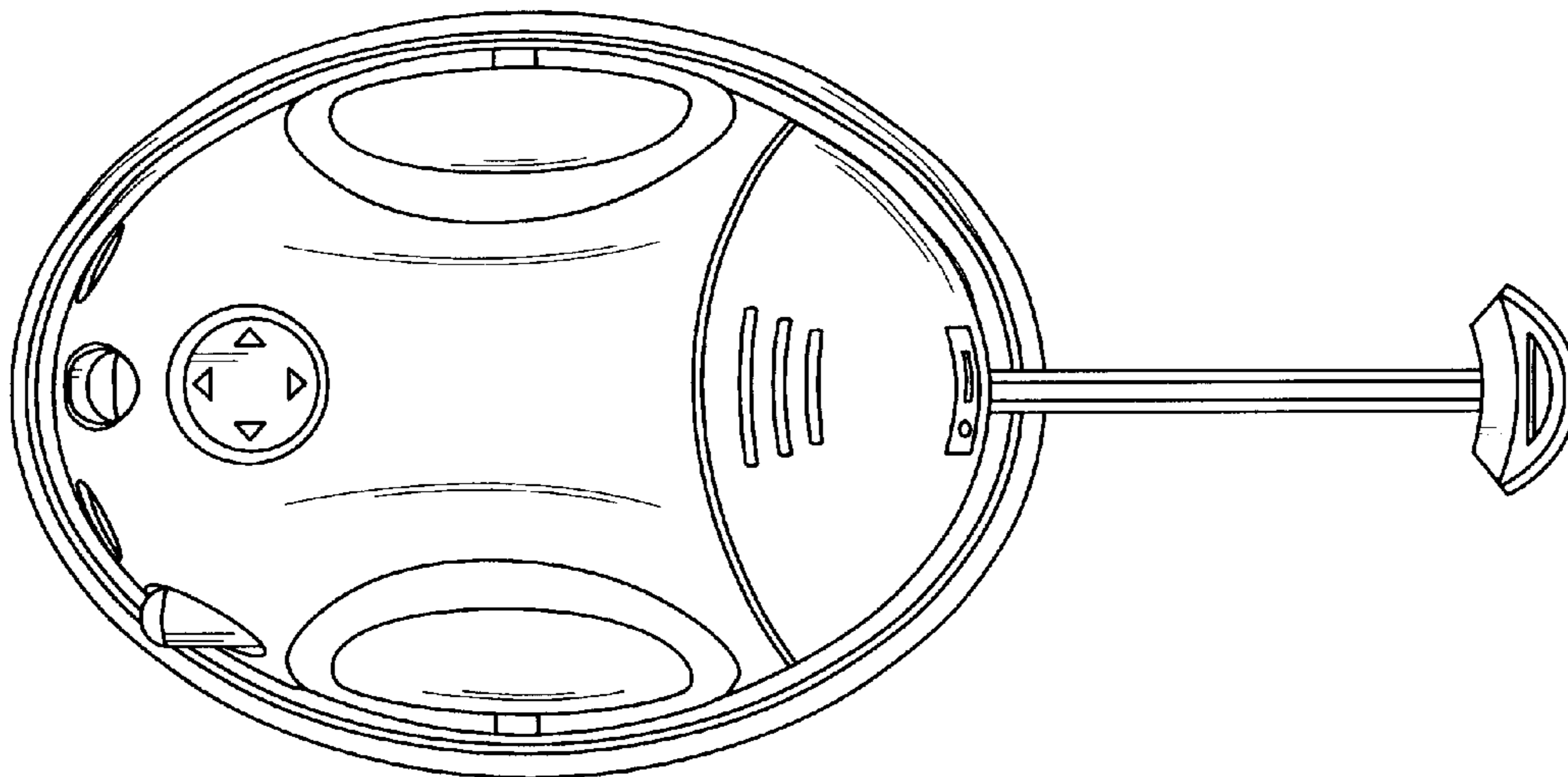

FIG. 10

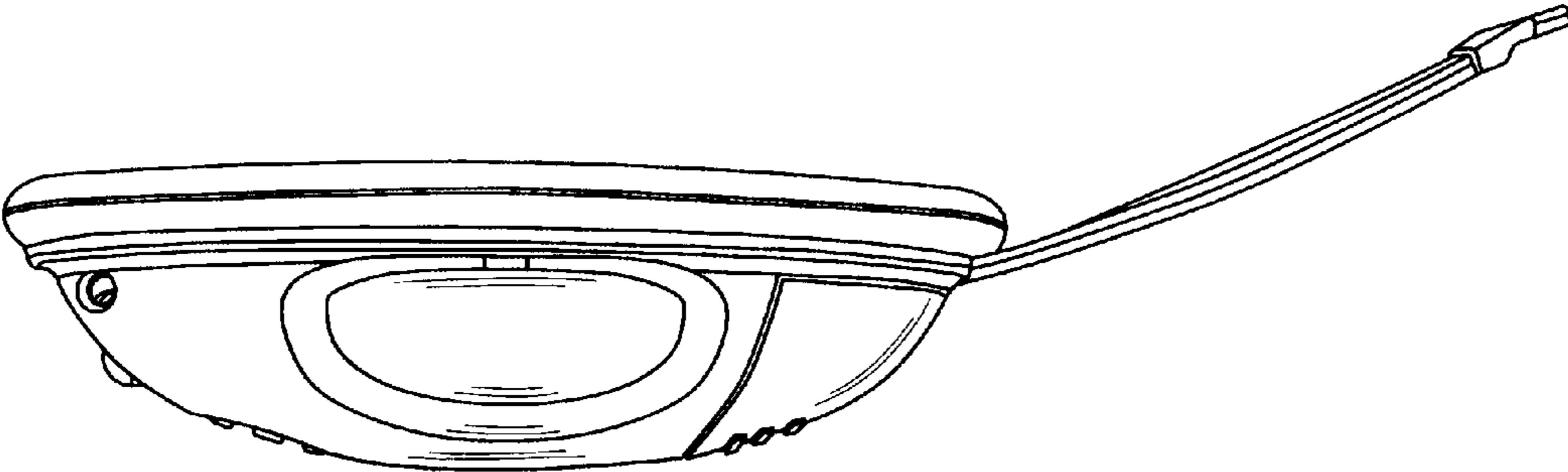

FIG. 12

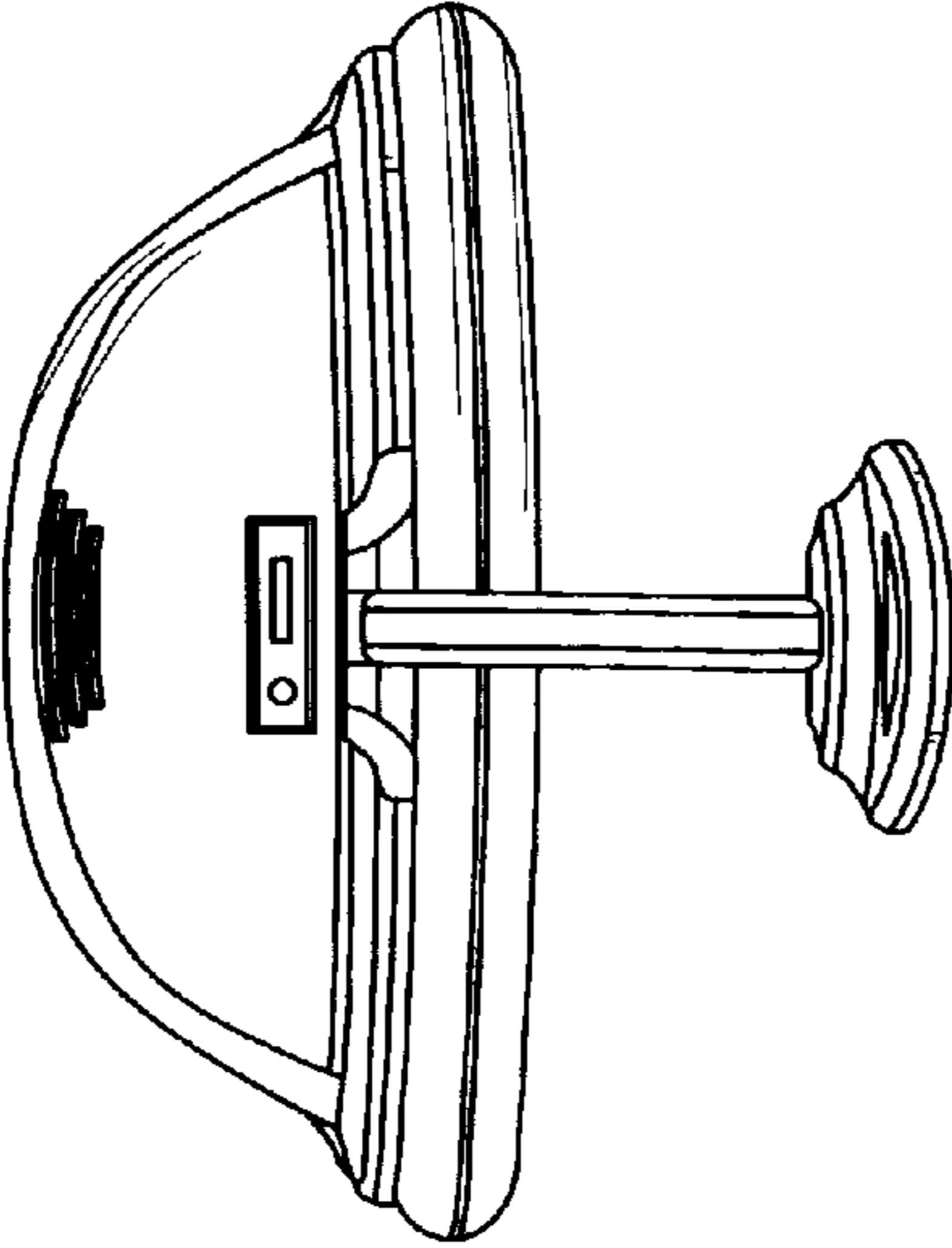

FIG. 14

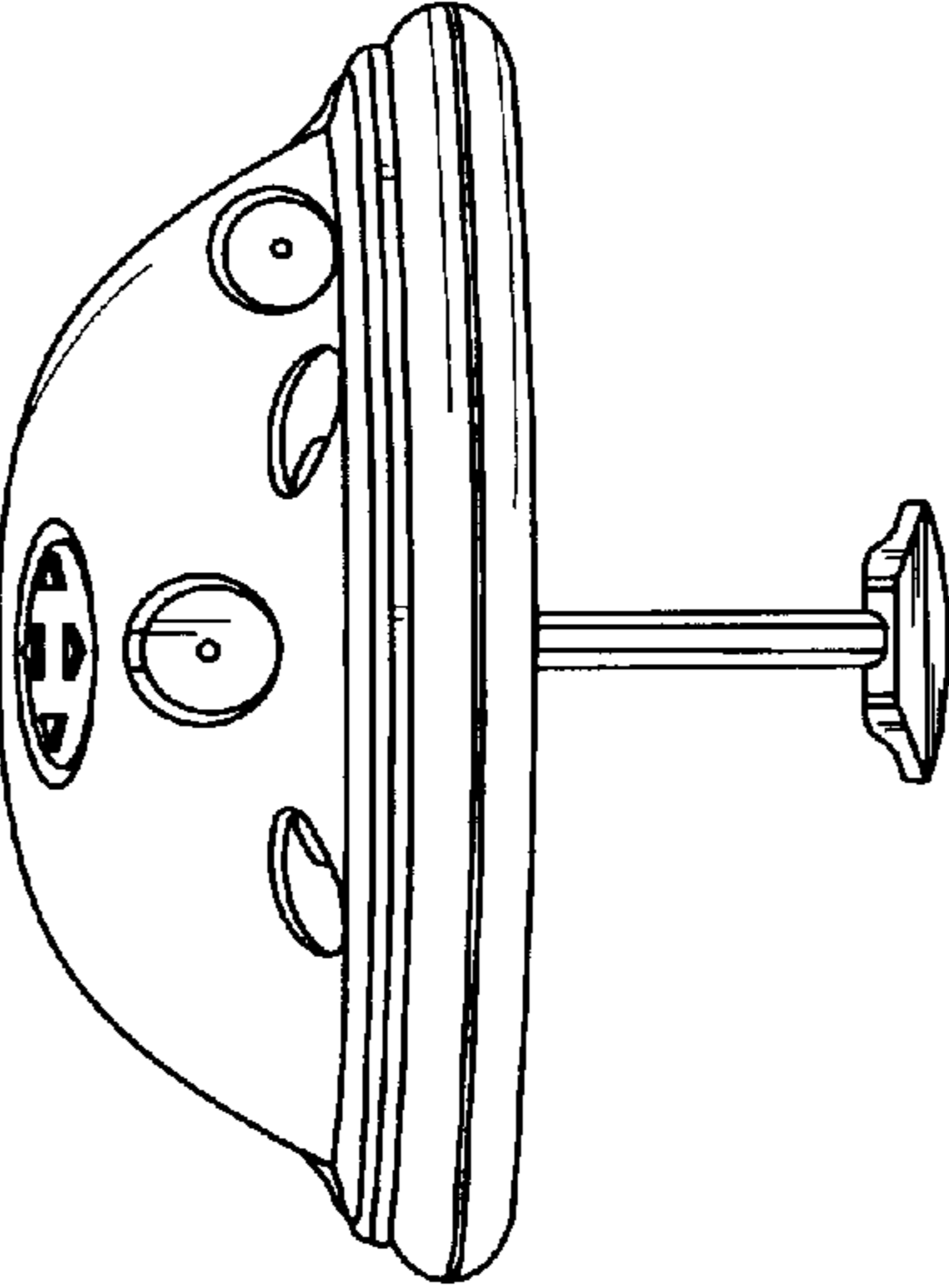

FIG. 13