



US00D509151S

(12) **United States Design Patent** (10) **Patent No.:** **US D509,151 S**
Takach et al. (45) **Date of Patent:** **** Sep. 6, 2005**

(54) **THERMOSTAT HOUSING**

FOREIGN PATENT DOCUMENTS

(75) Inventors: **Eugene J. Takach**, Eden Prairie, MN (US); **John Wadsworth**, Los Angeles, CA (US); **John von Buelow**, Oak Park, CA (US)

WO WO 01/93779 12/2001

OTHER PUBLICATIONS

Carrier, "Programmable Dual Fuel Thermostat," Installation, Start-Up & Operating Instructions, pp. 1-12, Oct. 1998.

(73) Assignee: **Honeywell International Inc.**, Morristown, NJ (US)

(Continued)

(**) Term: **14 Years**

Primary Examiner—Antoine D. Davis

(74) *Attorney, Agent, or Firm*—Gregory M. Ansems

(21) Appl. No.: **29/205,143**

(22) Filed: **May 10, 2004**

(57) **CLAIM**

The ornamental design for a thermostat housing, as shown and described.

(51) **LOC (8) Cl.** **10-04**

(52) **U.S. Cl.** **D10/50**

(58) **Field of Search** D10/49, 50; 236/46 R, 236/47, 49.3, 51, 84, 94; 400/485

DESCRIPTION

The present application is related to co-pending U.S. patent application Ser. No. 10/726,201, filed on Dec. 2, 2003, entitled "Controller Interface With Multiple Day Programming", U.S. patent application Ser. No. 10/726,247, filed on Dec. 2, 2003, entitled "Controller Interface With Menu Schedule Override", U.S. patent application Ser. No. 10/726,174, filed on Dec. 2, 2003, entitled "Programmable Controller With Saving Changes Indication", U.S. patent application Ser. No. 10/725,826, filed Dec. 2, 2003, entitled "Controller Interface With Separate Schedule Review Mode", U.S. patent application Ser. No. 10/726,243, filed Dec. 2, 2003, entitled "Controller With Programmable Service Event Display", and U.S. patent application Ser. No. 10/726,245, filed Dec. 2, 2003, entitled Controller Interface With Interview Programming.

FIG. 1 is a perspective view of a thermostat housing; FIG. 2 is a front elevation view of the thermostat housing of FIG. 1; and, FIGS. 3-6 are elevation views from the bottom, right, top and left, respectively, of the thermostat housing of FIG. 1. The broken line portions of the thermostat housing shown in the figures are for illustrative purposes only and form no part of the claimed design.

(56) **References Cited**

U.S. PATENT DOCUMENTS

4,079,366 A	3/1978	Wong
4,174,807 A	11/1979	Smith et al.
4,206,872 A	6/1980	Levine
4,264,034 A	4/1981	Hyltin et al.
4,298,946 A	11/1981	Hartsell et al.
4,308,991 A	1/1982	Peinetti et al.
4,337,822 A	7/1982	Hyltin et al.
4,382,544 A	5/1983	Stewart
4,386,649 A	6/1983	Hines et al.
4,388,692 A	6/1983	Jones et al.
4,431,134 A	2/1984	Hendricks et al.
4,442,972 A	4/1984	Sahay et al.
4,446,913 A	5/1984	Krocker
4,479,604 A	10/1984	Didner
4,606,401 A	8/1986	Levine et al.
4,621,336 A	11/1986	Brown
4,717,333 A	1/1988	Carignan
4,725,001 A	2/1988	Carney et al.
4,837,731 A	6/1989	Levine et al.
4,881,686 A	11/1989	Mehta

(Continued)

1 Claim, 6 Drawing Sheets

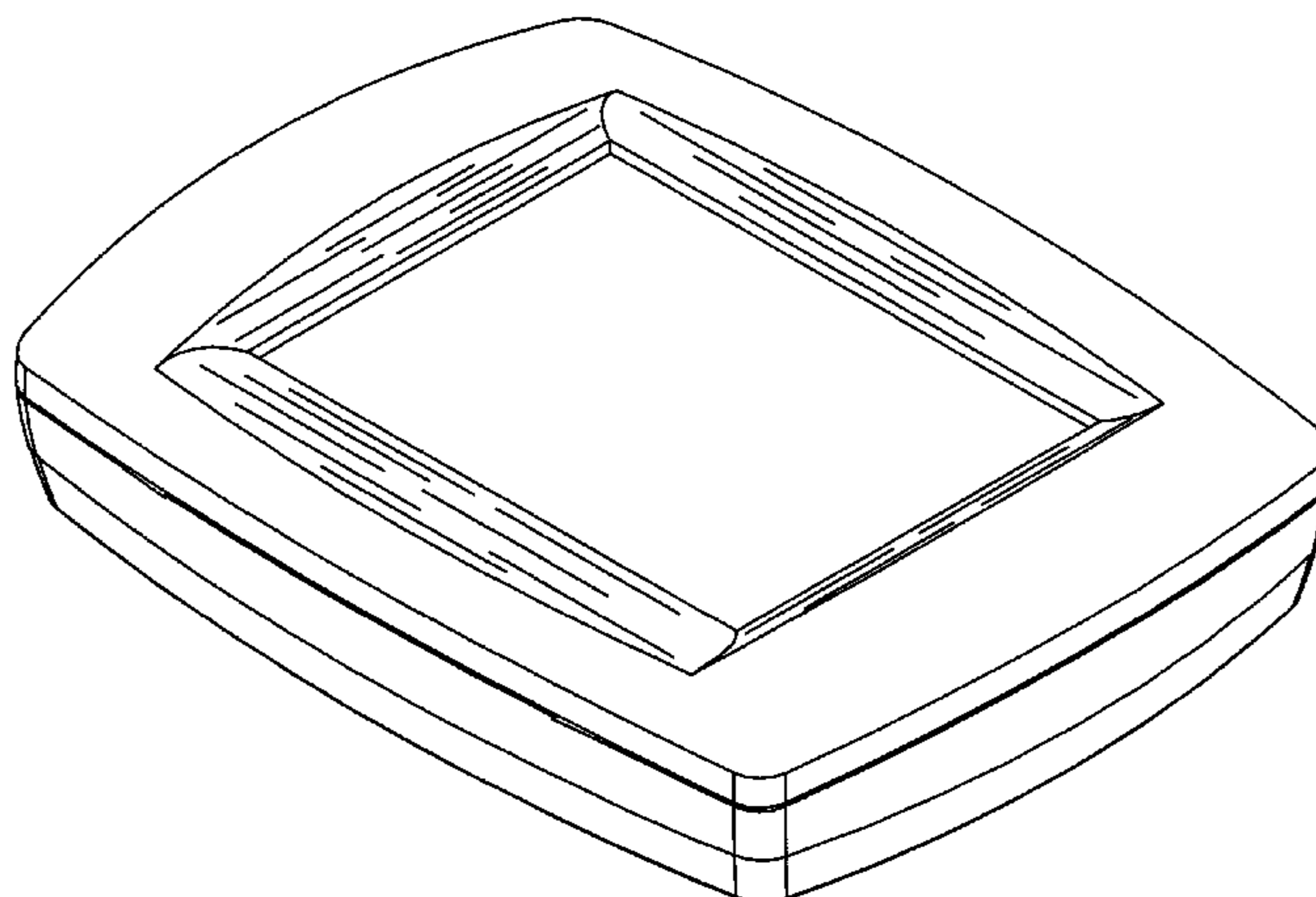

U.S. PATENT DOCUMENTS

4,918,439	A	4/1990	Wozniak et al.	
4,948,040	A	8/1990	Kobayashi et al.	
4,992,779	A	2/1991	Sugino et al.	
4,997,029	A	3/1991	Otsuka et al.	
5,012,973	A	5/1991	Dick et al.	
5,038,851	A	8/1991	Metha	
5,065,813	A	11/1991	Berkeley et al.	
5,088,645	A	2/1992	Bell	
5,161,606	A	11/1992	Berkeley et al.	
5,181,653	A	1/1993	Foster et al.	
5,230,482	A	7/1993	Ratz et al.	
5,259,445	A	11/1993	Pratt et al.	
5,329,991	A	7/1994	Metha et al.	
5,348,078	A	9/1994	Dushane et al.	
D361,287	S *	8/1995	Guy et al.	D10/50
5,482,209	A	1/1996	Cochran et al.	
D367,430	S *	2/1996	Greenberg et al.	D10/49
5,526,422	A	6/1996	Keen	
5,537,106	A	7/1996	Mitcuhashi	
5,566,879	A	10/1996	Longtin	
5,570,837	A	11/1996	Brown et al.	
5,673,850	A	10/1997	Uptegraph	
5,782,296	A	7/1998	Metha	
5,873,519	A	2/1999	Beilfuss	
5,901,183	A	5/1999	Garin et al.	
5,902,183	A	5/1999	D'Souza	
5,937,942	A	8/1999	Bias et al.	
6,032,867	A	3/2000	Dushane et al.	
6,196,467	B1	3/2001	Dushane et al.	
6,208,331	B1	3/2001	Singh et al.	
6,315,211	B1	11/2001	Sartain et al.	
6,318,639	B1	11/2001	Toth	
6,351,693	B1	2/2002	Monie et al.	
6,502,758	B2	1/2003	Cottrell	
6,513,723	B1 *	2/2003	Mueller et al.	236/46 R
6,518,957	B1	2/2003	Lehtinen et al.	
6,581,846	B1	6/2003	Rosen	
6,595,430	B1	7/2003	Shah	
2002/0005435	A1	1/2002	Cottrell	
2003/0034897	A1	2/2003	Shamoon et al.	
2003/0034898	A1	2/2003	Shamoon et al.	
2003/0121652	A1	7/2003	Carey et al.	
2003/0142121	A1	7/2003	Rosen	

OTHER PUBLICATIONS

Carrier, "Programmable Thermostats," Installation, Start-Up & Operating Instructions, pp. 1-16, Sep. 1998.

Carrier, "Standard Programmable Thermostat," Homeowner's Manual, pp. 1-8 pages, 1998.

Carrier, "Thermostat Control," Installation, Start-Up, and Operating Instructions, pp. 1-12, Aug. 1999.

CorAccess, "Companion 6," User Guide, pp. 1-20, Jun. 17, 2002.

<http://www.thermostatsales.com>, Robertshaw, "9610 Digital Programmable Thermostat," 3 pages, printed Jun. 17, 2004.

<http://www.thermostatsales.com>, Robertshaw, "9700 Deluxe Programmable Thermostat" 3 pages, printed Jun. 17, 2004.

<http://www.thermostatsales.com>, Robertshaw, "9710 Deluxe Programmable Thermostat," 3 pages, printed Jun. 17, 2004.

<http://www.thermostatsales.com>, Robertshaw, "9720 Deluxe Programmable Thermostat," 3 pages, printed Jun. 17, 2004.

Hunter, "44200/44250," Owner's Manual, 32 pages, printed prior to filing date.

Hunter, "44300/44350," Owner's Manual, 35 pages, printed prior to filing date.

Invensys™, "9700i 9701i 9715i 9720i Deluxe Programmable Thermostats," User's Manual, pp. 1-28, printed prior to filing date.

Lux, "511 Series Smart Temp Electronic Thermostat," Owner's Manual, 3 pages, printed prior to filing date.

Lux, "600 Series Smart Temp Electronic Thermostat," Owner's Manual, 3 pages, printed prior to filing date.

Lux, "602 Series Multi-Stage Programmable Thermostat," Owner's Manual, 2 pages, printed prior to filing date.

Lux, "605/2110 Series Programmable Heat Pump Thermostat," Owner's Manual, 3 pages, printed prior to filing date.

Hunter, "Auto Saver 550", Owner's Manual Model 44550, 44 pages, printed prior to filing date.

Lux, "700/9000 Series Smart Temp Electronic Thermostat," Owner's Manual, 3 pages, printed prior to filing date.

Lux, "PSPH521 Series Programmable Heat Pump Thermostat," Owner's Manual, 3 pages, printed prior to filing date.

Lux, "TX1500 Series Smart Temp Electronic Thermostat," Owner's Manual, 6 pages, printed prior to filing date.

Lux, "TX500 Series Smart Temp Electronic Thermostat," Owner's Manual, 3 pages, printed prior to filing date.

Lux, "ELV1 Programmable Line Voltage Thermostat," Owner's Manual, 3 pages, printed prior to filing date.

Metasys, "HVAC Pro for Windows User's Manual," 308 pages, 1998.

http://www.ritetemp.info/rtMenu_13.html, Rite Temp 8082, 8 pages, printed Jun. 20, 2003.

Totaline, "1 For All programmable Digital Thermostat," Owner's Manual P/N P374-1100FM, 23 pages, Nov. 1998.

Totaline, "1 For All Programmable Digital Thermostat," Owner's Manual P/N P474-1050, 21 pages, Nov. 1998.

Totaline, "1 For All Programmable Digital Thermostat," Owner's Manual P/N P374-1100, 24 pages, Apr. 2001.

Totaline, "Intellistat Combination Temperature and Humidity Control," Owner's Manual P/N P374-1600, 25 pages, Jun. 2001.

Totaline, "Programmable Thermostat Configurable for Advanced Heat Pump or Dual Fuel Operation," Owner's Manual P/N P374-1500, 24 pages, Jun. 1999.

Totaline, "Instructions P/N P474-1010", Manual, 2 pages, Dec. 1998.

Totaline, "Programmable Thermostat", Homeowner's Guide, 27 pages, Dec. 1998.

Totaline, "Wireless Programmable Digital Thermostat," Owner's Manual 474-1100RF, 21 pages, 2000.

Warmly Yours, "Model TH111GFCI-P (120 VAC)," Manual, pp. 1-4, printed prior to filing date.

White-Rodgers, "Installation Instructions for Heating & Air Conditioning IF72 5/2 Day Programmable Heat Pump Thermostat," 8 pages, printed prior to filing date.

White-Rodgers, "Installation Instructions for Heating & Air Conditioning IF78 5/2 Day Programmable Thermostat," 7 pages, printed prior to filing date.

White-Rodgers, "Comfort-Set 90 Series Thermostat," Manual, pp. 1-24, printed prior to filing date.

White-Rodgers, "Comfort-Set III Thermostat," Manual, pp. 1-44, printed prior to filing date.

White-Rodgers, 1F80-240 "(for Heating Only systems) Programmable Electronic Digital Thermostat," Installation and Operation Instructions, 8 pages, printed prior to filing date.

White-Rodgers, 1F80-241 "Programmable Electronic Digital Thermostat," Installation and Operation Instructions, 6 pages, printed prior to filing date.

White-Rodgers, 1F80-261 "Programmable Electronic Digital Thermostat," Installation and Operation Instructions, 8 pages, printed prior to filing date.

White-Rodgers, 1F81-261 "Programmable Electronic Digital Multi-Stage Thermostat," Installation and Operation Instructions, 8 pages, printed prior to filing date.

White-Rodgers, 1F82-261 "Programmable Electronic Digital Heat Pump Thermostat," Installation and Operation Instructions, 8 pages, printed prior to filing date.

www.icmcontrols.com, Simplecomfort, SC3000 Single Stage Heat/Single Stage Cool or Single Stage Heat Pump/Manual Changeover, 1 page, printed prior to filing date.

www.icmcontrols.com, Simplecomfort, SC3001 Single Stage Heat/Single Stage Cool or Single Stage Heat Pump/Manual Changeover, 1 page, printed prior to filing date.

www.icmcontrols.com, Simplecomfort, SC3006 Single Stage Heat/Single Stage Cool or Single Stage Heat Pump/Manual Changeover, 1 page, printed prior to filing date.

www.icmcontrols.com, Simplecomfort, SC3201 2 Stage Heat Pump Manual Changeover, 1 page, printed prior to filing date.

www.icmcontrols.com, Simplecomfort, SC3801 2 Stage Heat/2 Stage Cool 2 Stage Heat Pump/Audio Changeover, 1 page, printed prior to filing date.

* cited by examiner

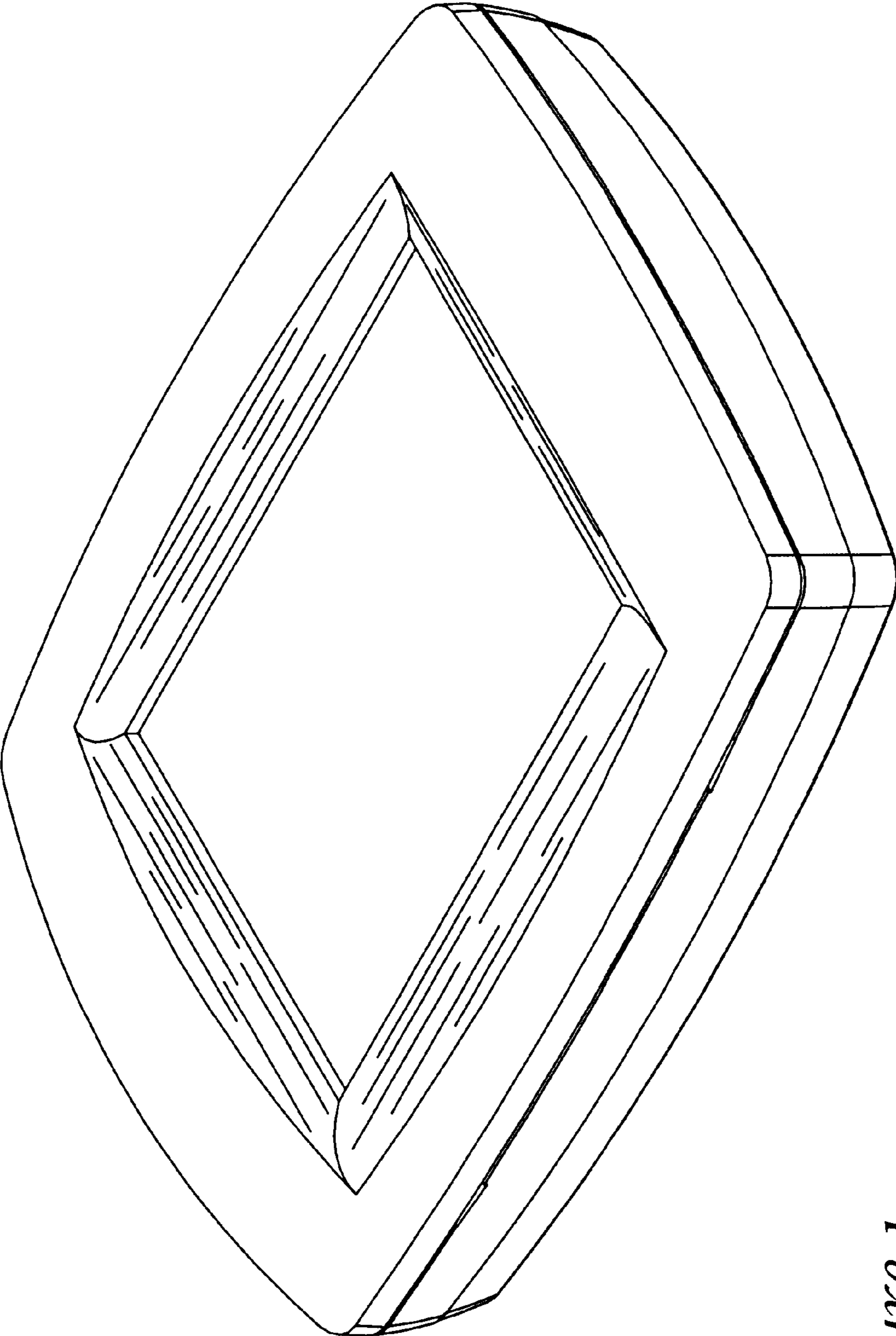

Figure 1

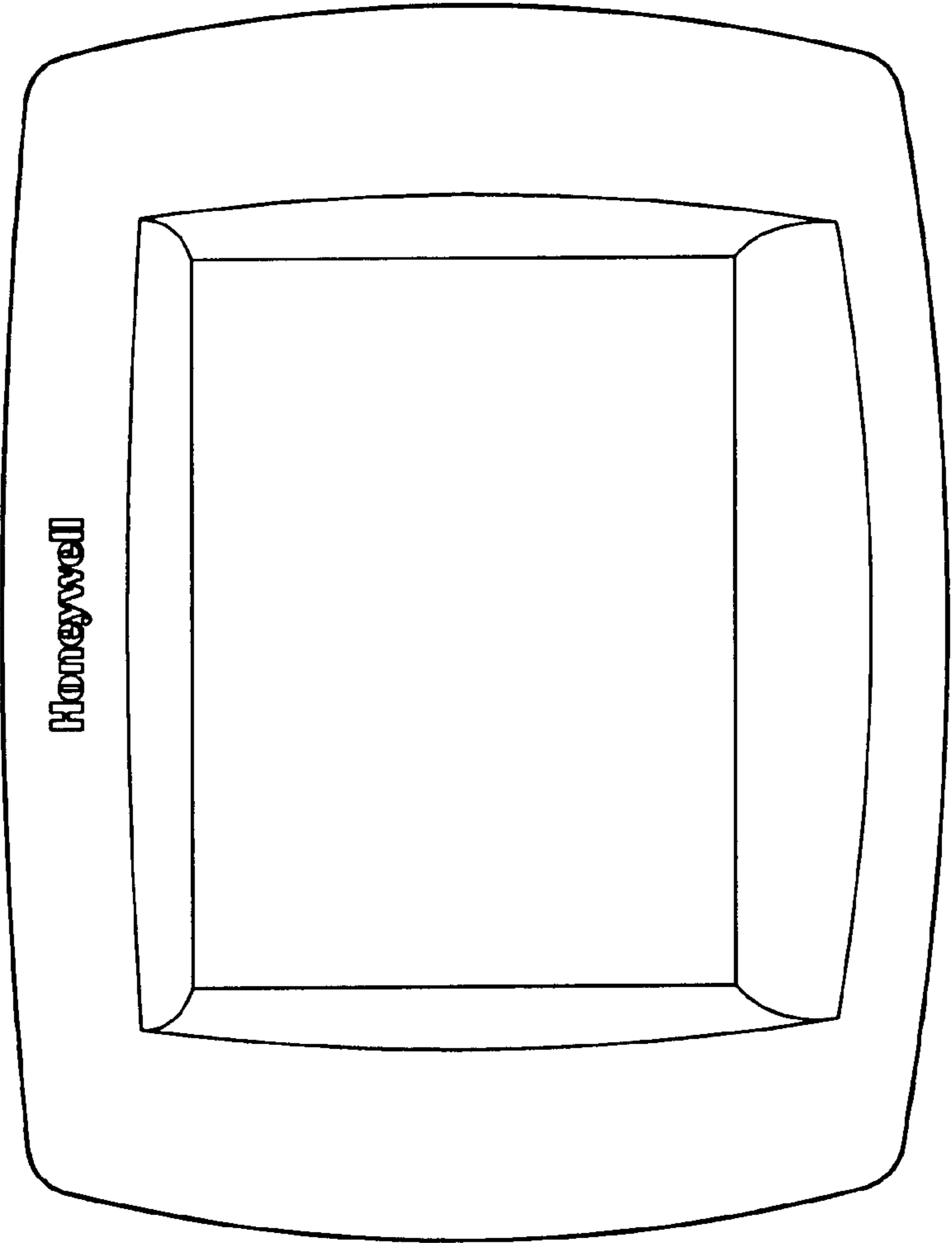

Figure 2

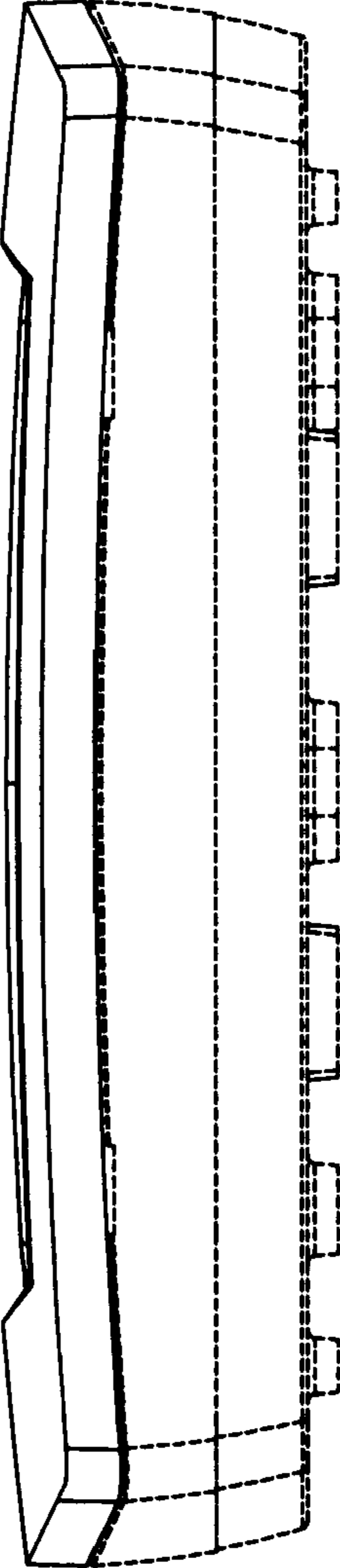

Figure 3

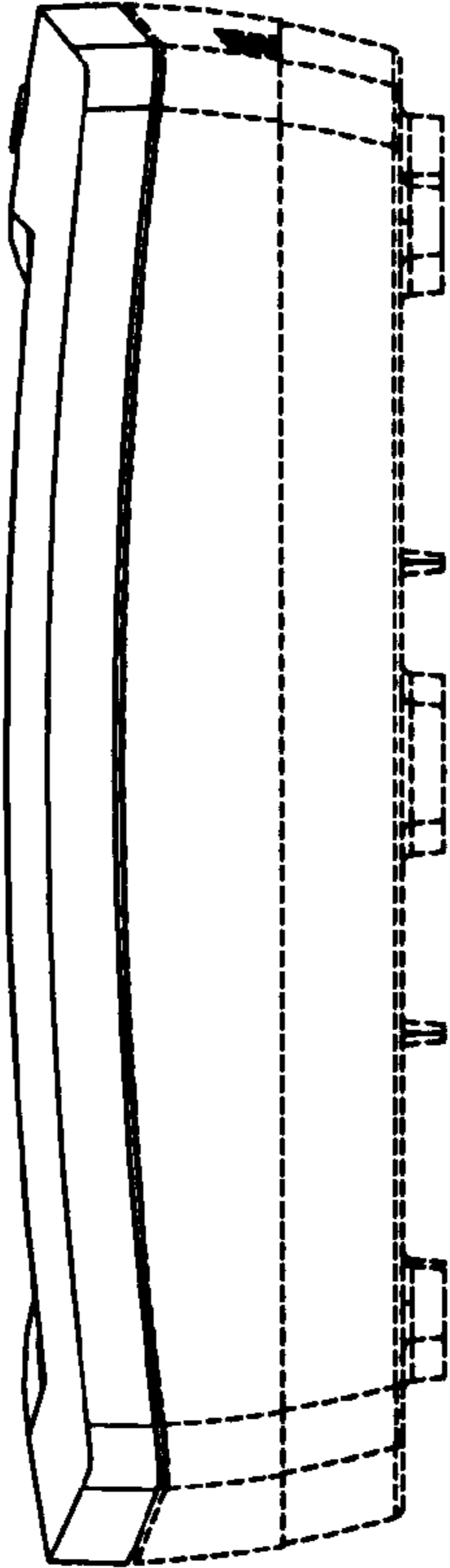

Figure 4

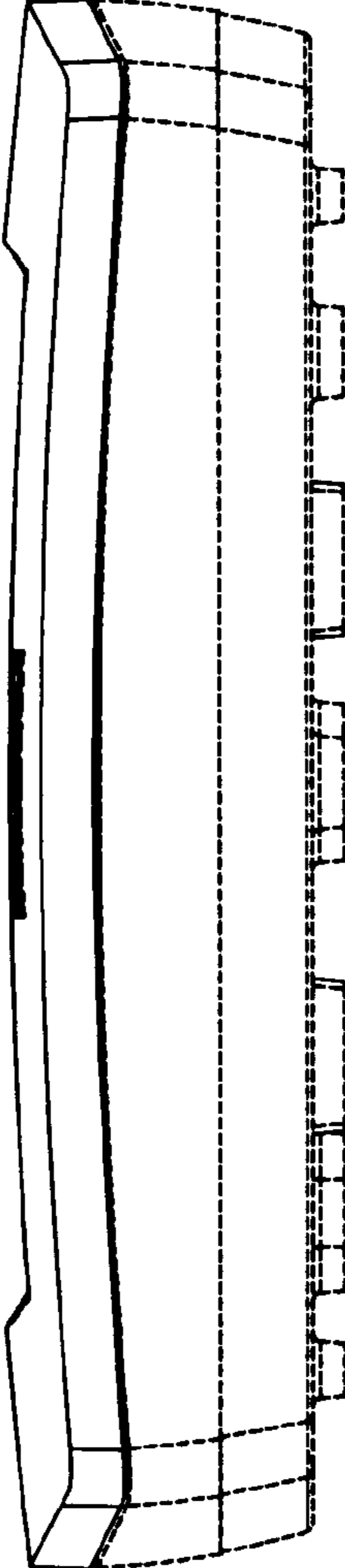

Figure 5

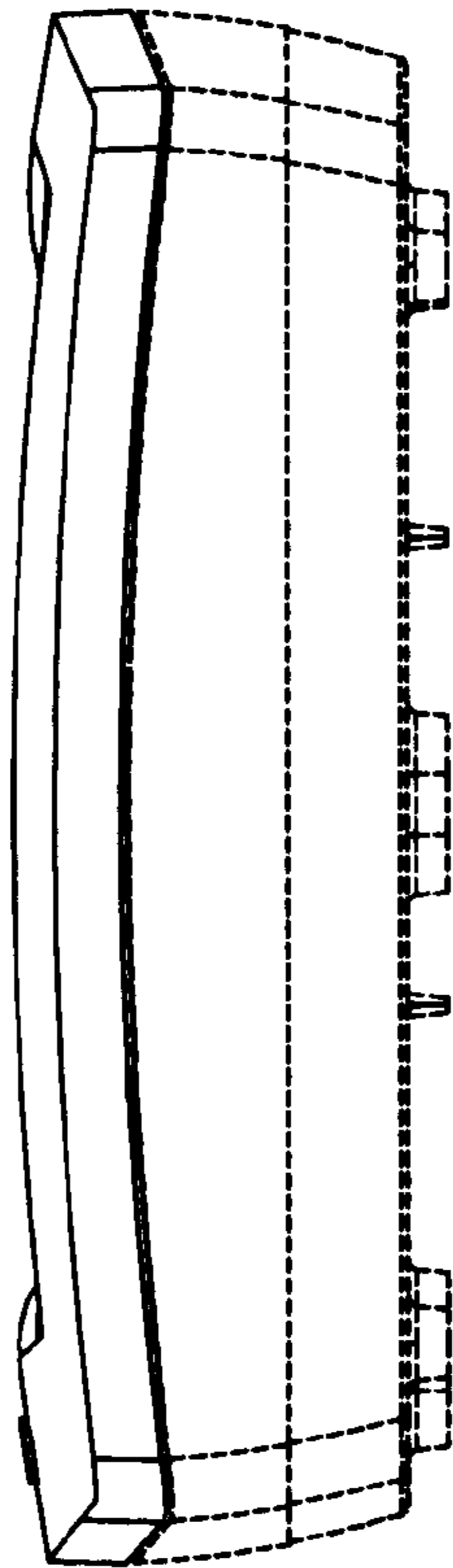

Figure 6