

US00D509019S

(12) **United States Design Patent**
Castro et al.

(10) **Patent No.: US D509,019 S**

(45) **Date of Patent: ** Aug. 30, 2005**

(54) **LAMP**

D337,847 S * 7/1993 Meck et al. D26/110

(75) Inventors: **Ramon Ubeda Castro**, Barcelong (ES);
Carlos Riera Cortes, Barcelona (ES)

* cited by examiner

(73) Assignee: **Metalarte, S.A.**, Barcelona (ES)

Primary Examiner—Alan P. Douglas

Assistant Examiner—Linda Brooks

(**) Term: **14 Years**

(74) *Attorney, Agent, or Firm*—Dennison, Schultz,
Dougherty & MacDonald

(21) Appl. No.: **29/203,573**

(57) **CLAIM**

(22) Filed: **Apr. 16, 2004**

The ornamental design for a lamp, as shown and described.

(30) **Foreign Application Priority Data**

DESCRIPTION

Nov. 19, 2003 (EM) 100839

(51) **LOC (8) Cl.** **26-03**

(52) **U.S. Cl.** **D26/112**

(58) **Field of Search** D26/93, 106–112;
362/410–414

FIG. 1 is a side view;
FIG. 2 is an enlarged top view;
FIG. 3 is an enlarged bottom view;
FIG. 4 is an upper perspective view;
FIG. 5 is a lower perspective view;
FIG. 6 is top perspective view; and,
FIG. 7 is an enlarged view of a portion of the lower
perspective view of FIG. 5.

(56) **References Cited**

U.S. PATENT DOCUMENTS

D334,823 S * 4/1993 Meck et al. D26/110

1 Claim, 7 Drawing Sheets

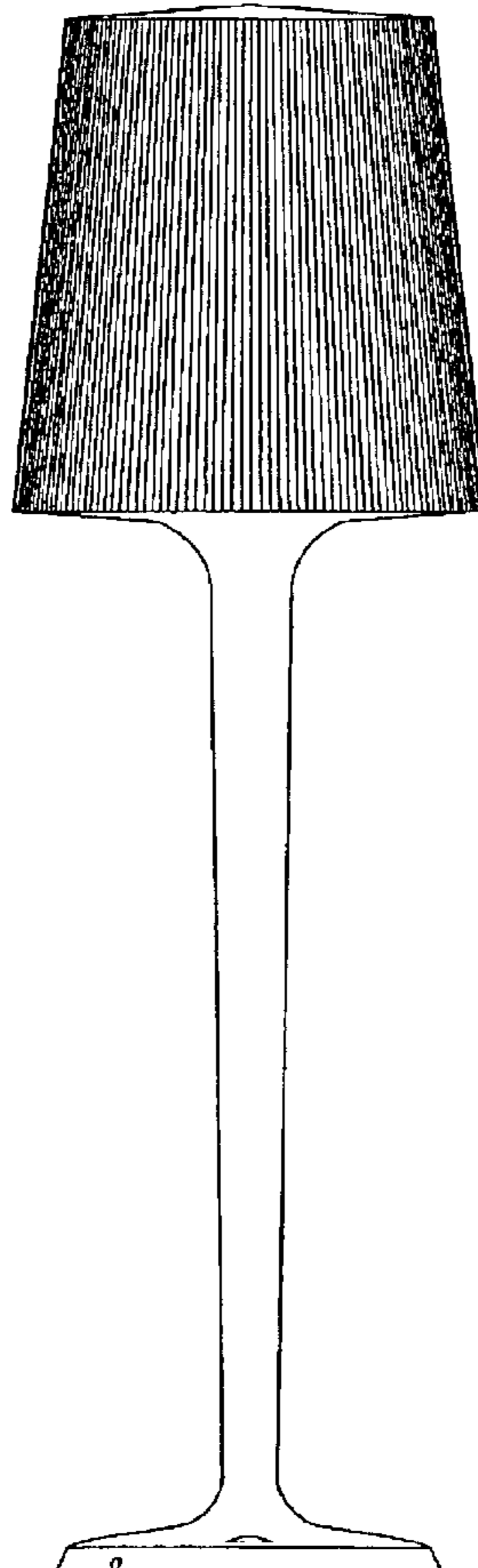

Figure 1

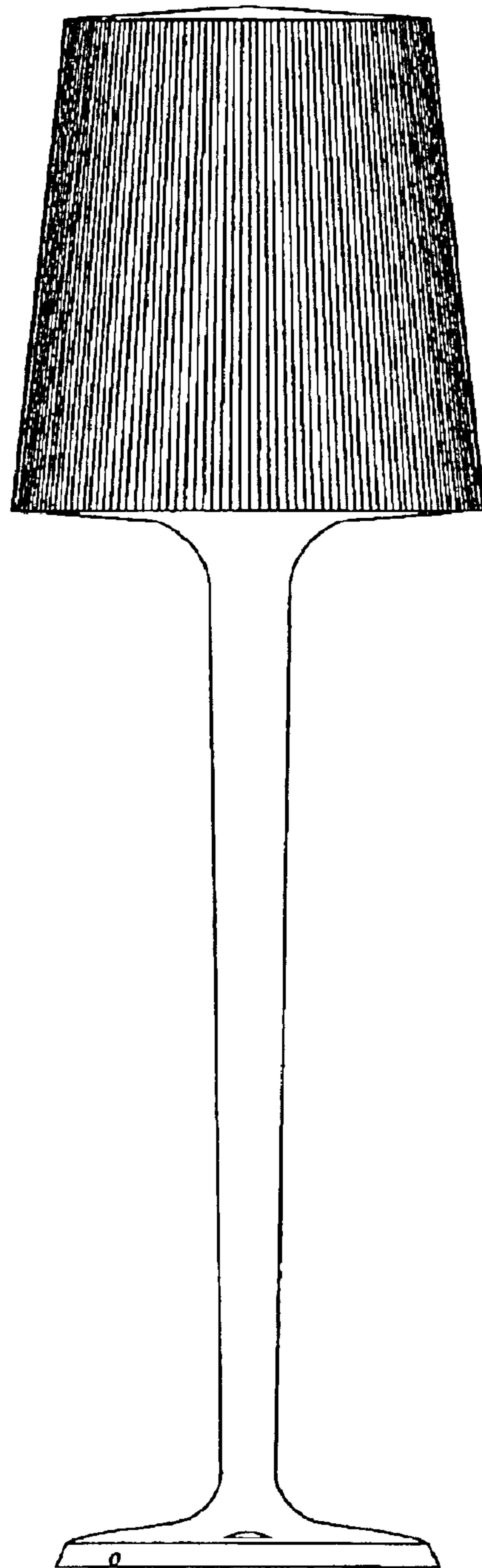

Figure 2

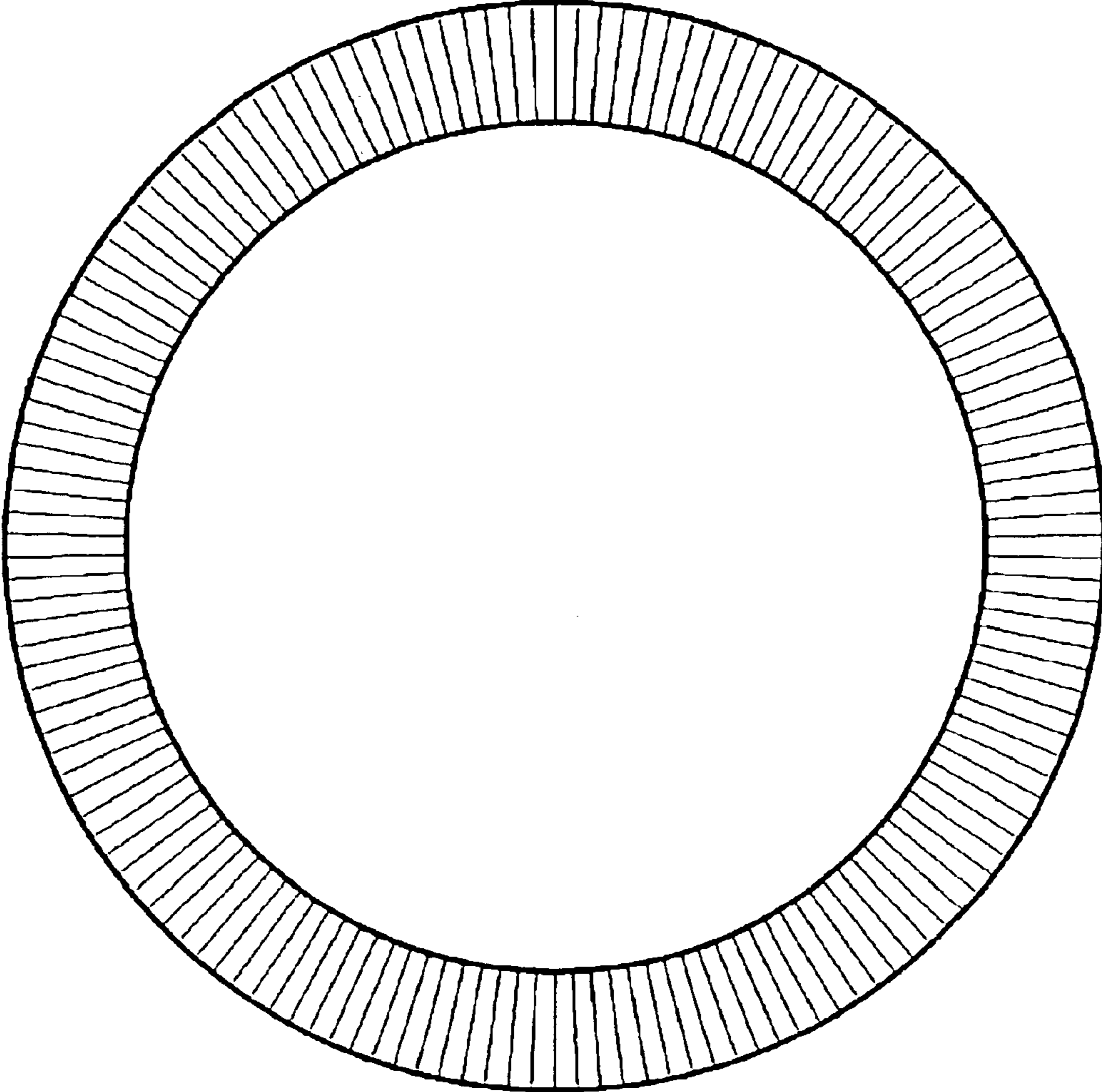

Figure 3

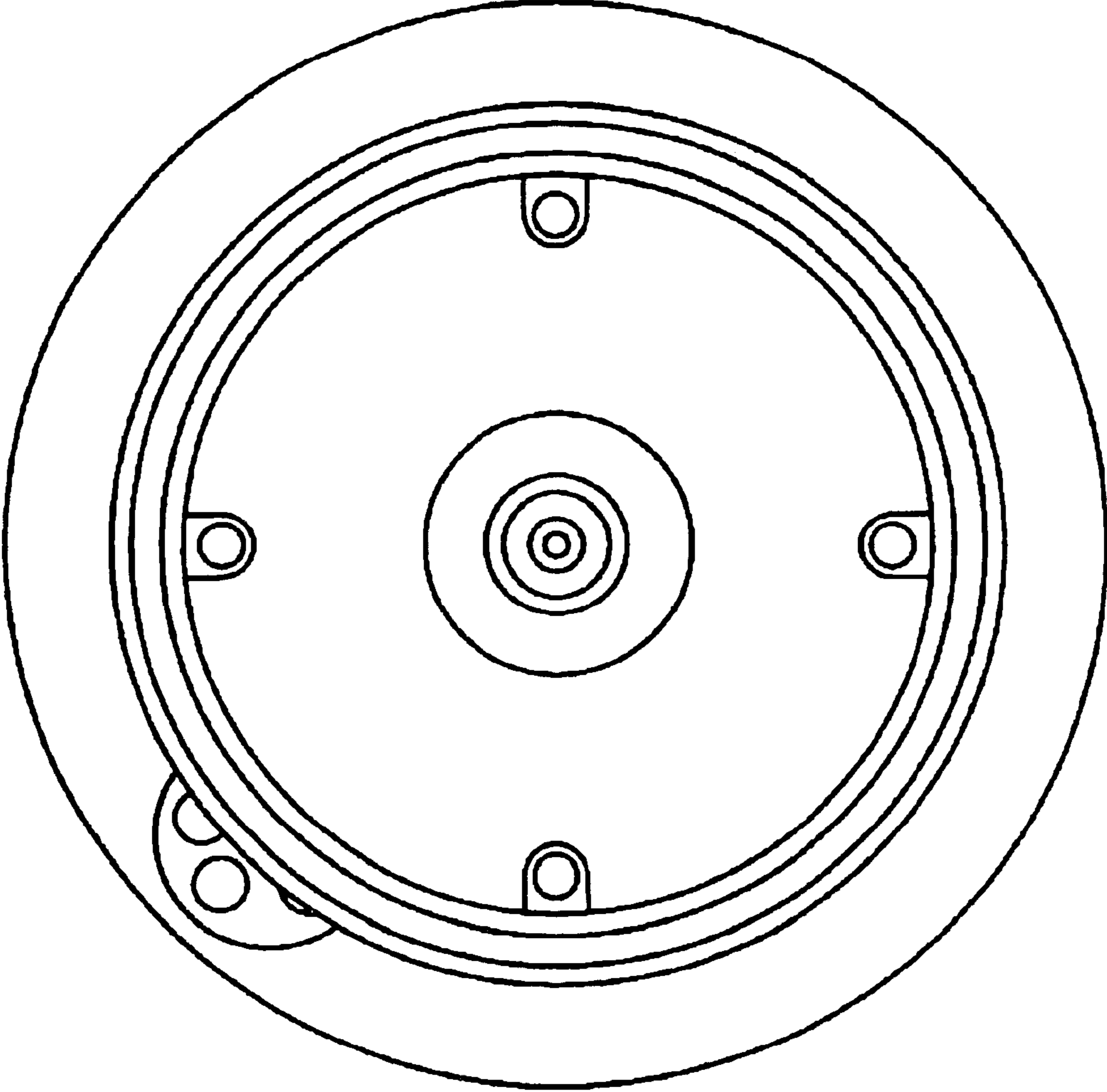

Figure 4

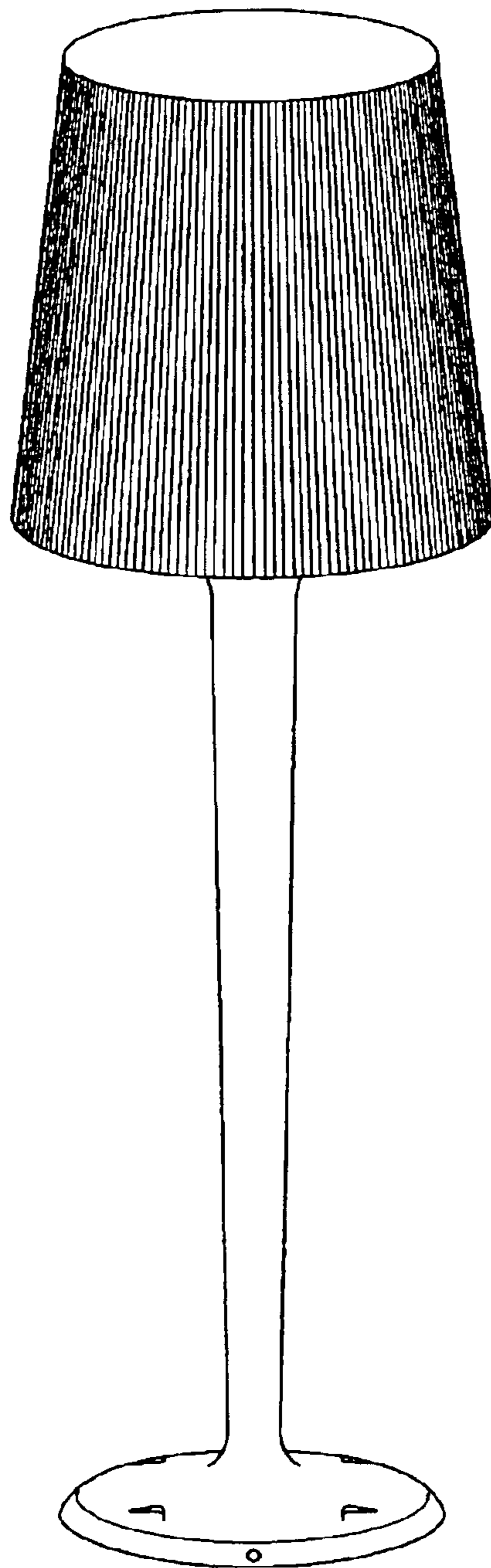

Figure 5

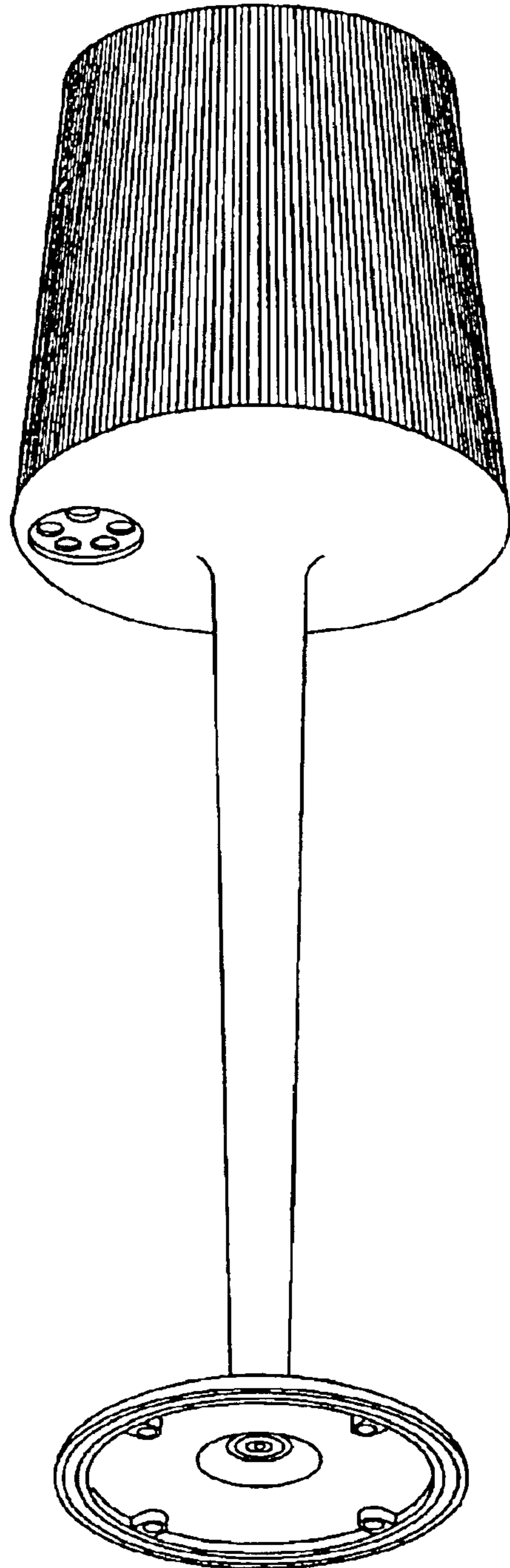

Figure 6

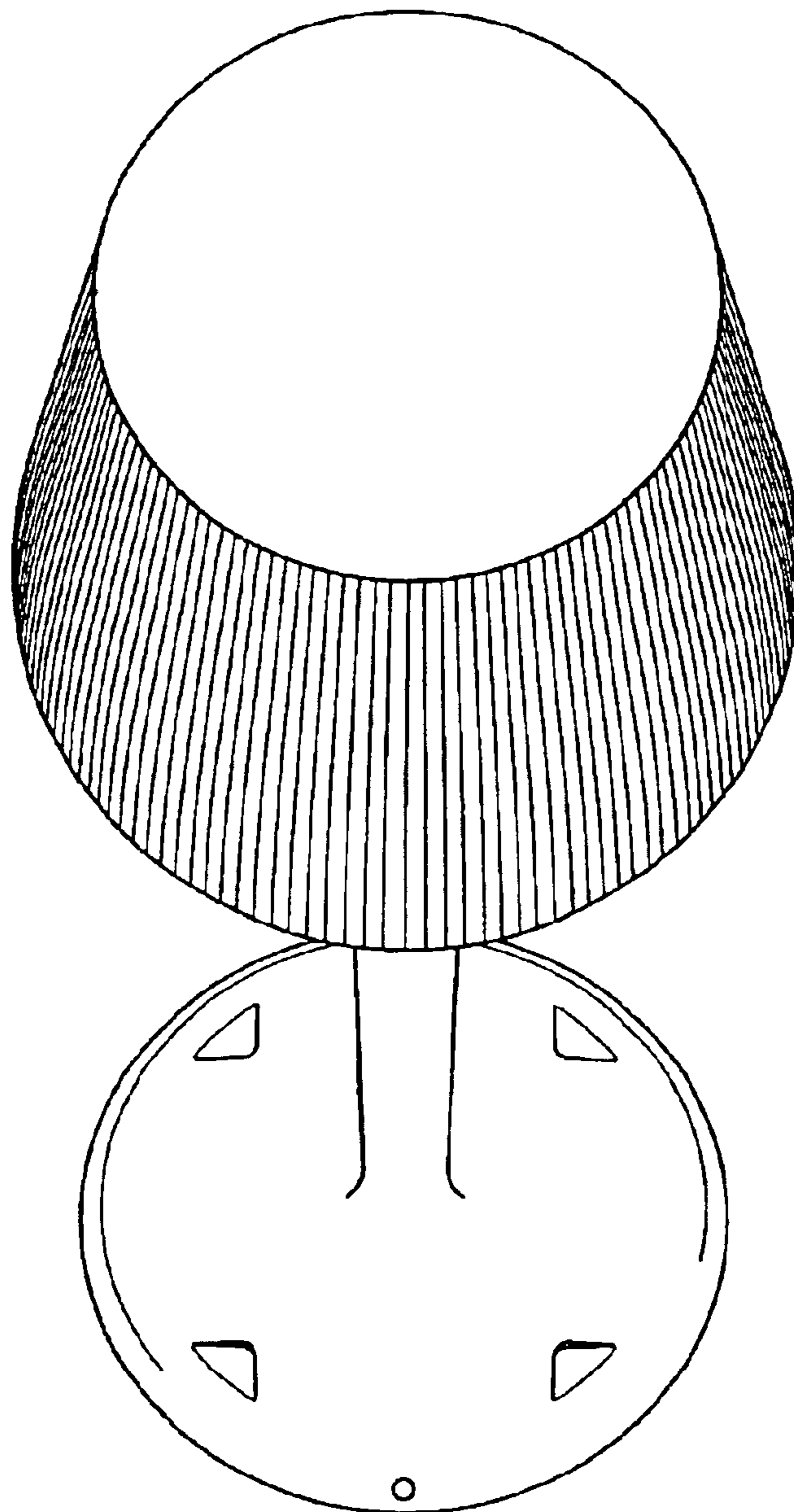

Figure 7

