

US00D508986S

(12) **United States Design Patent**
Peng

(10) **Patent No.:** **US D508,986 S**

(45) **Date of Patent:** **** Aug. 30, 2005**

(54) **AUTO-CONTROLLED STOOL SEAT**

D402,740 S * 12/1998 Ochi et al. D23/311
D485,606 S * 1/2004 Delgado et al. D23/311

(76) **Inventor:** **Shao-Yu Peng**, No. 45, Lane 10,
Jungjeng E. St., Huatan Shiang,
Changhua County (TW)

* cited by examiner

Primary Examiner—Robert A. Delehanty
(74) *Attorney, Agent, or Firm*—Troxell Law Office, PLLC

(**) **Term:** **14 Years**

(57) **CLAIM**

(21) **Appl. No.:** **29/208,861**

The ornamental design for a auto-controlled stool seat, as shown.

(22) **Filed:** **Jul. 8, 2004**

DESCRIPTION

(51) **LOC (8) Cl.** **23-02**

(52) **U.S. Cl.** **D23/311**

(58) **Field of Search** D23/273–274,
D23/295–299, 30, 309, 311–312; 4/663–664,
300, 444, 485–486, 234, 242.1, 237–239,
661, DIG. 6, DIG. 8

FIG. 1 is a perspective view of a auto-controlled stool seat showing my design;
FIG. 2 is a front view thereof;
FIG. 3 is a rear view thereof;
FIG. 4 is a left side view thereof;
FIG. 5 is a right side view thereof;
FIG. 6 is a top view thereof; and,
FIG. 7 is a bottom view thereof.

(56) **References Cited**

U.S. PATENT DOCUMENTS

D288,589 S * 3/1987 Stairs, Jr. D23/295

1 Claim, 7 Drawing Sheets

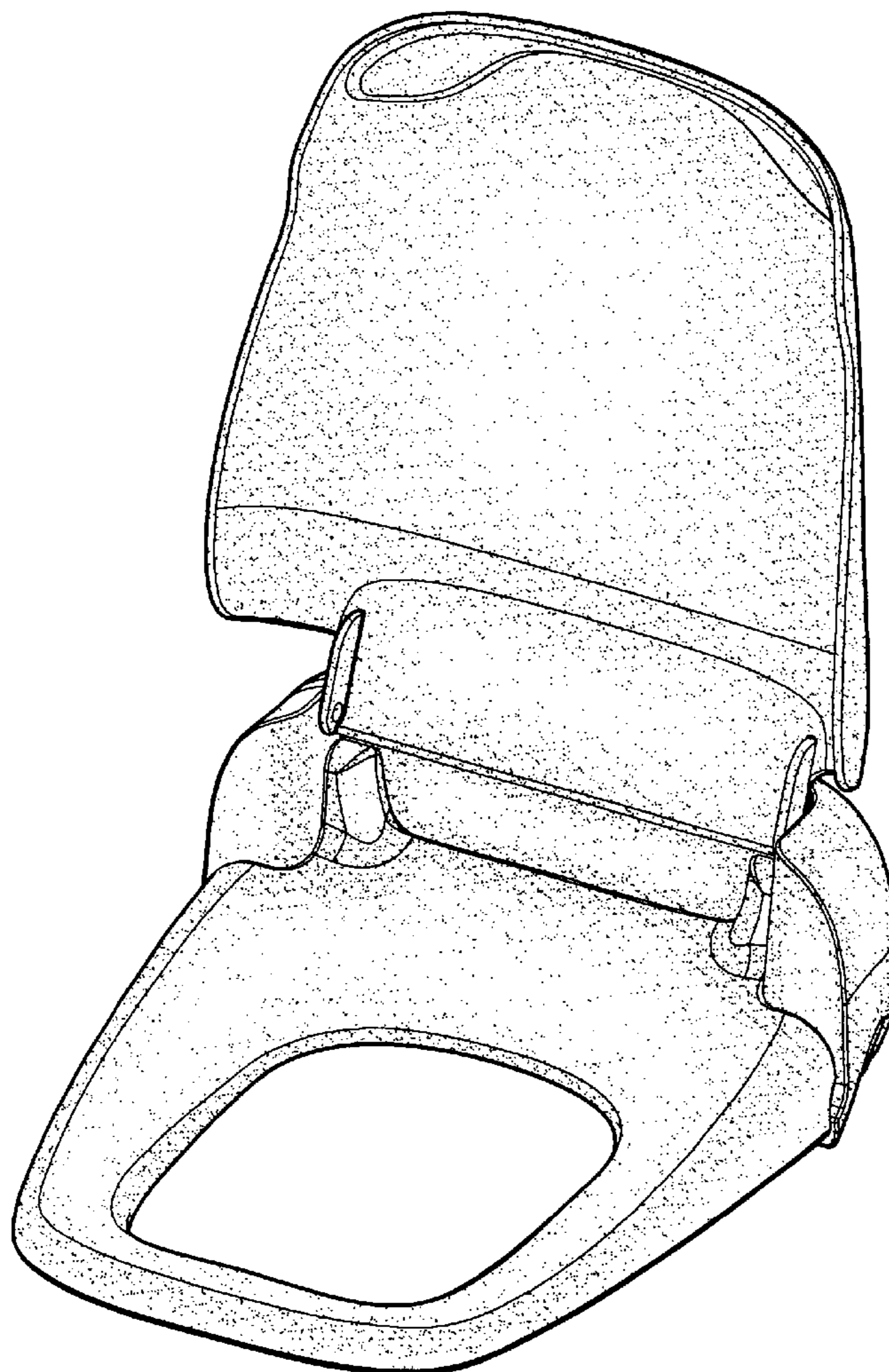

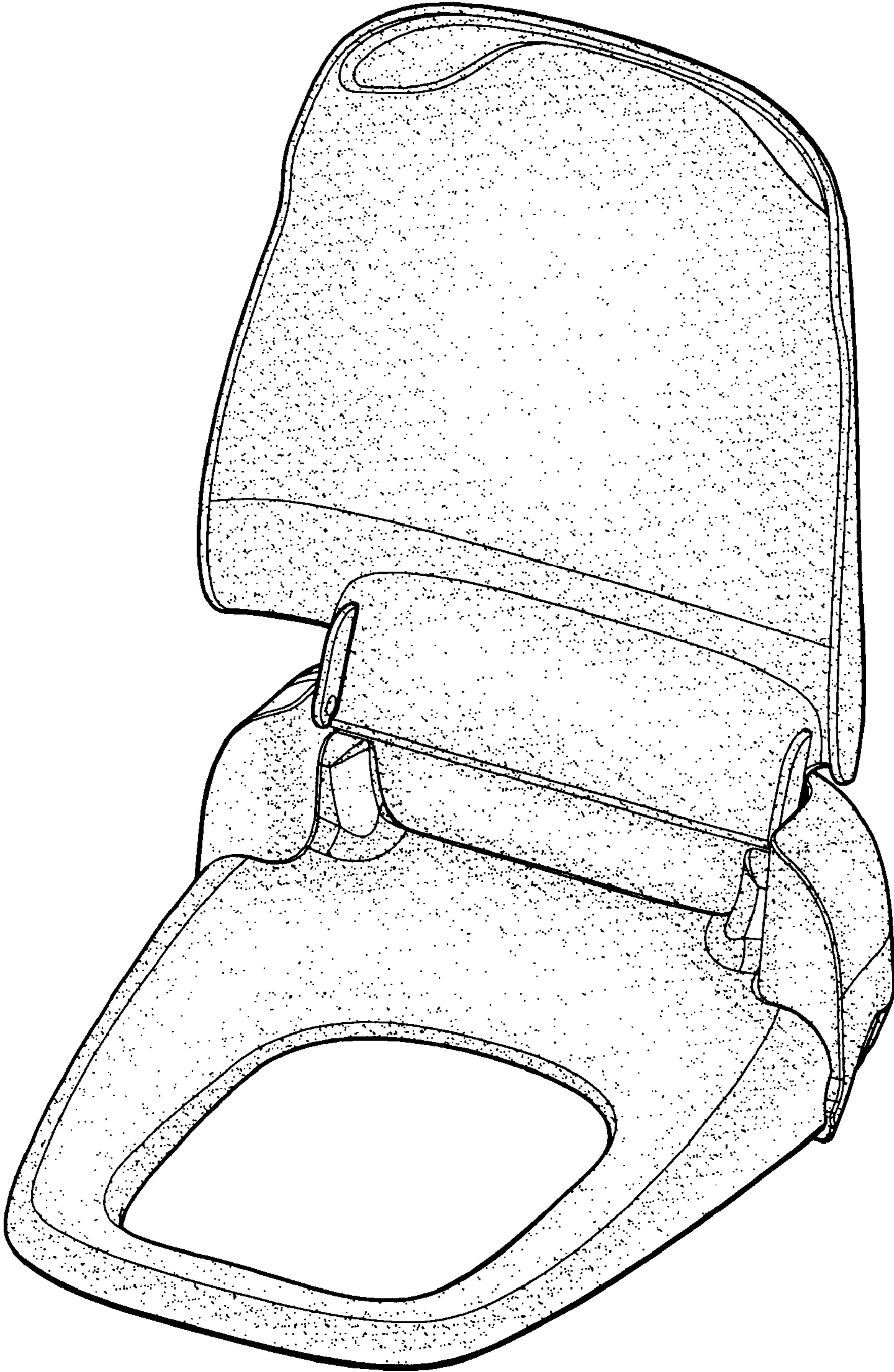

FIG. 1

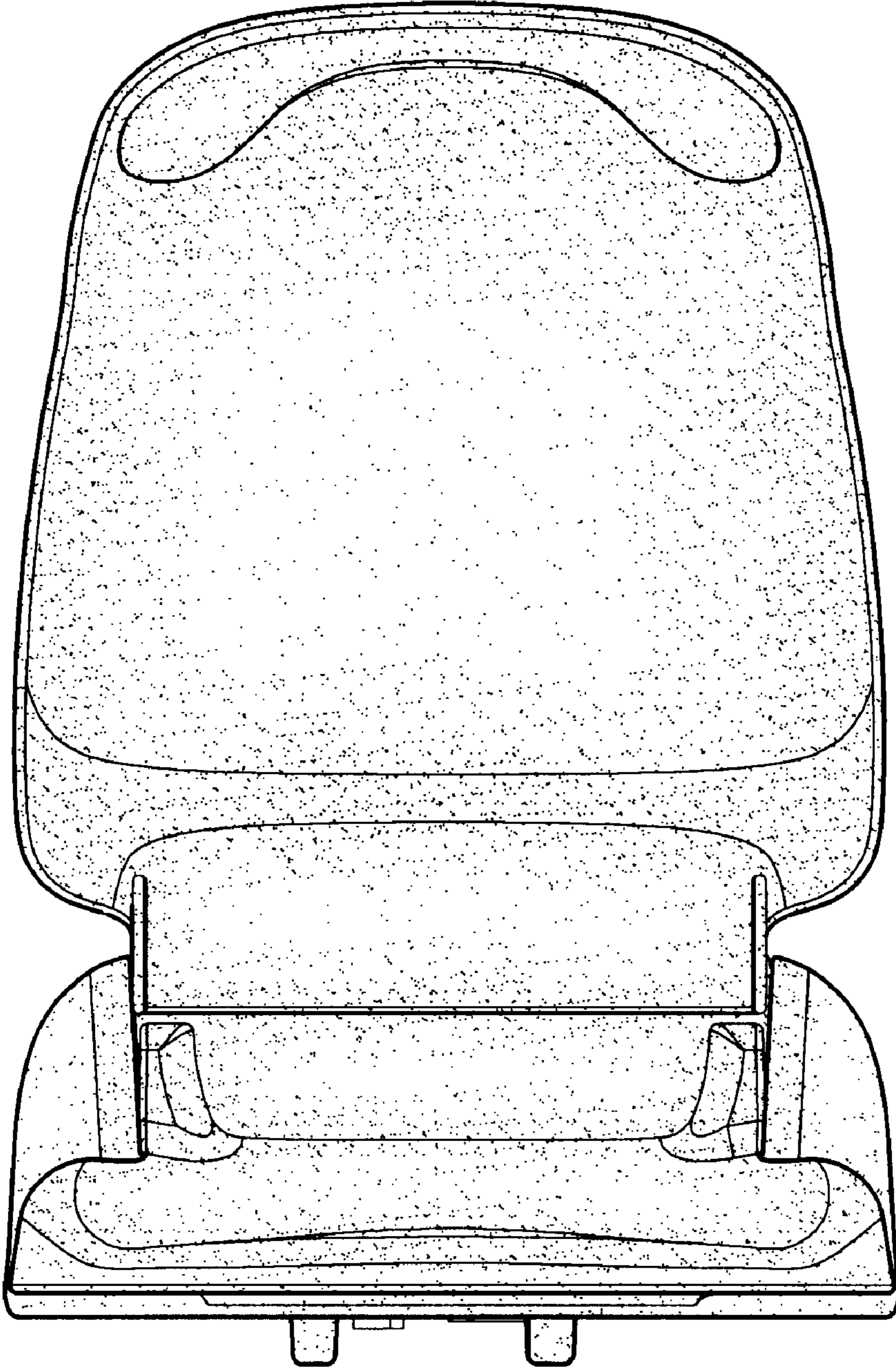

FIG. 2

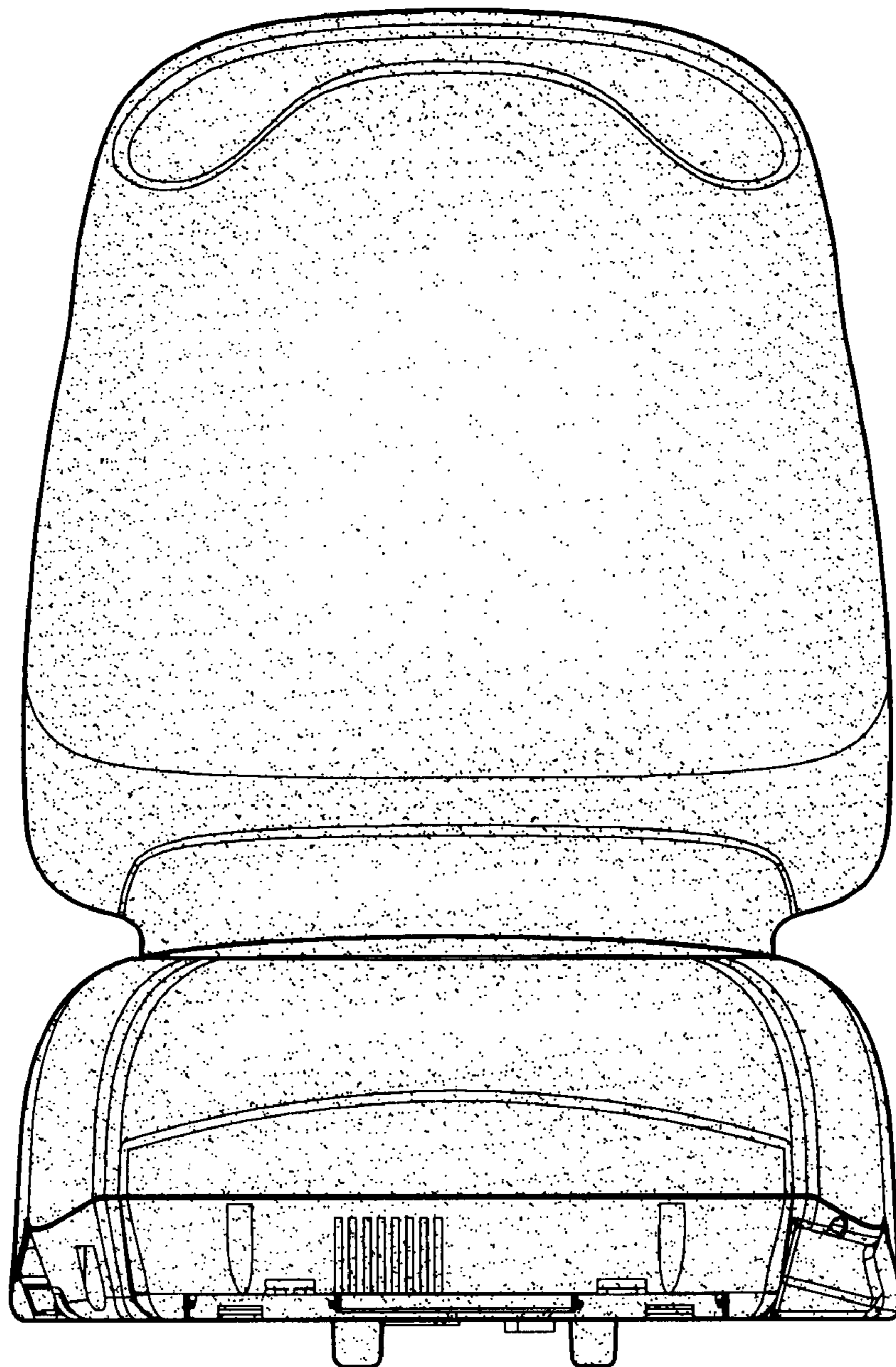

FIG. 3

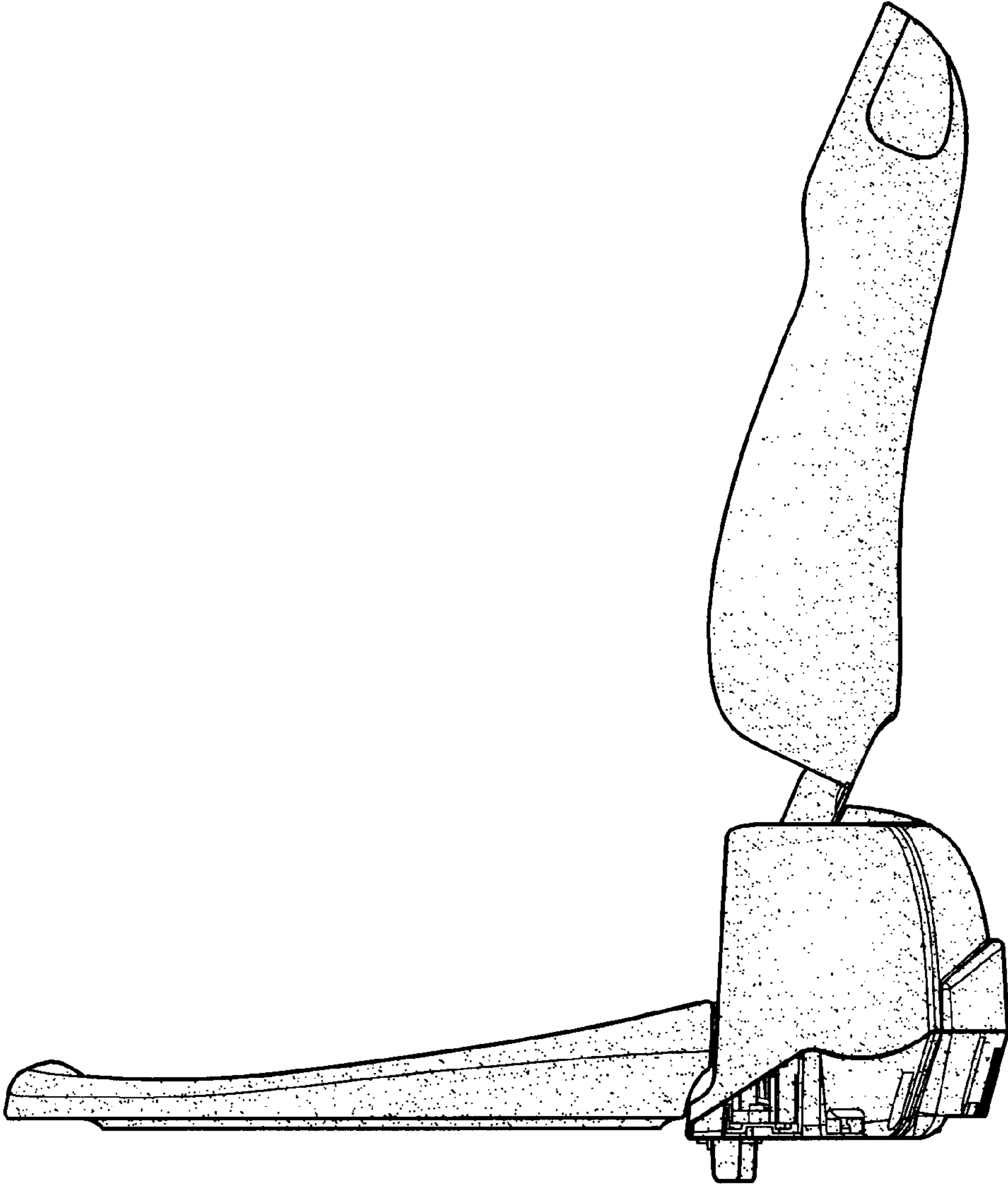

FIG. 4

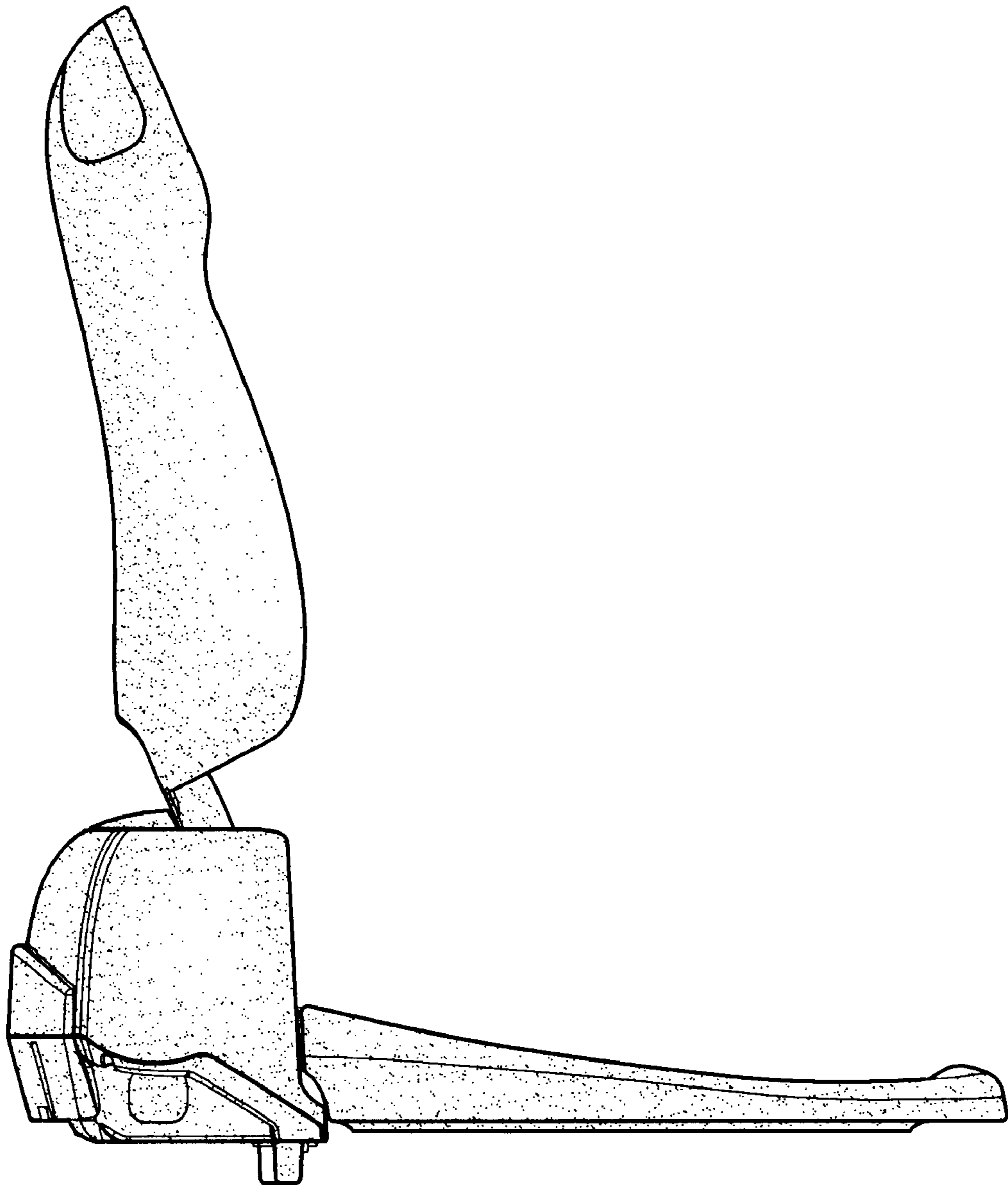

FIG. 5

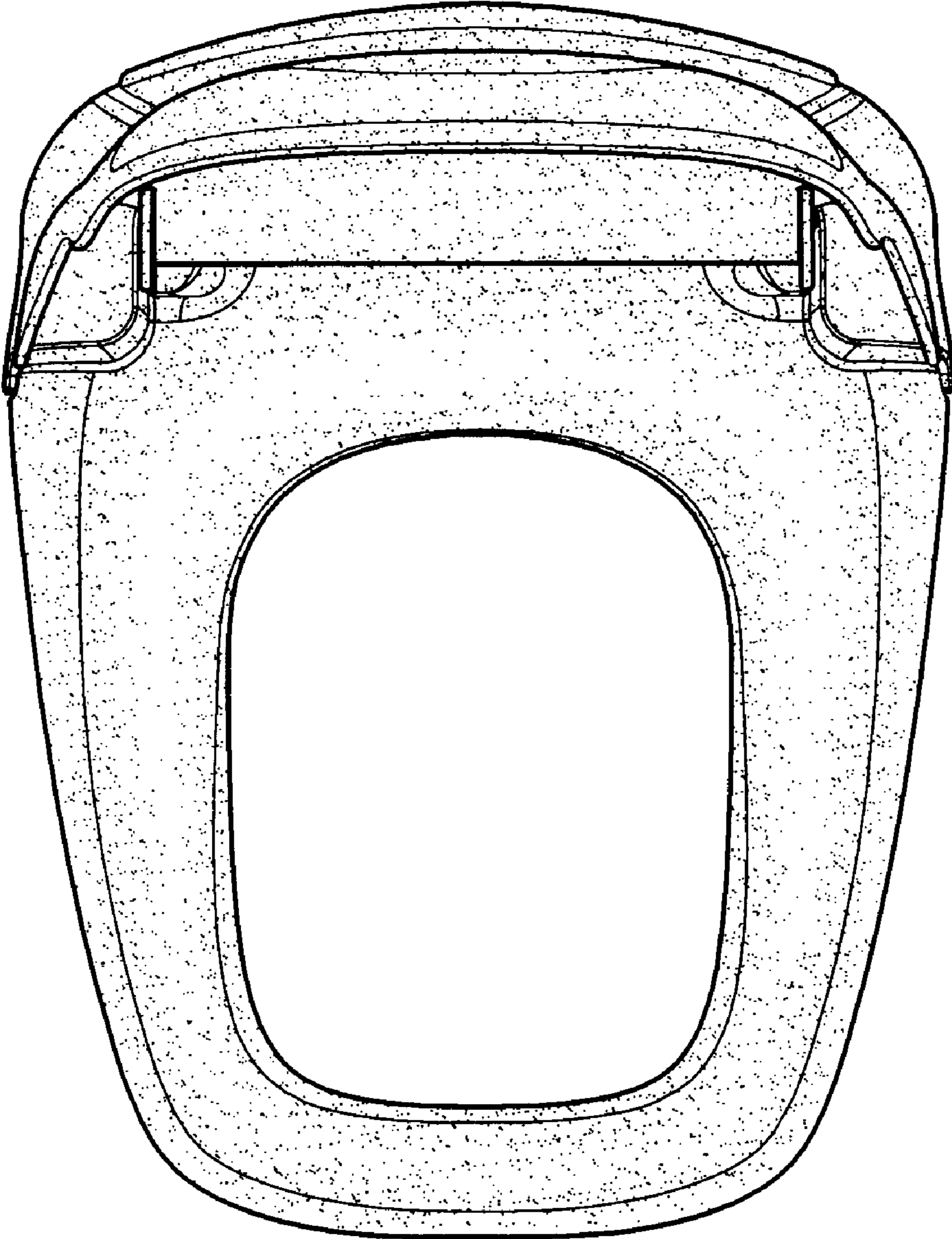

FIG. 6

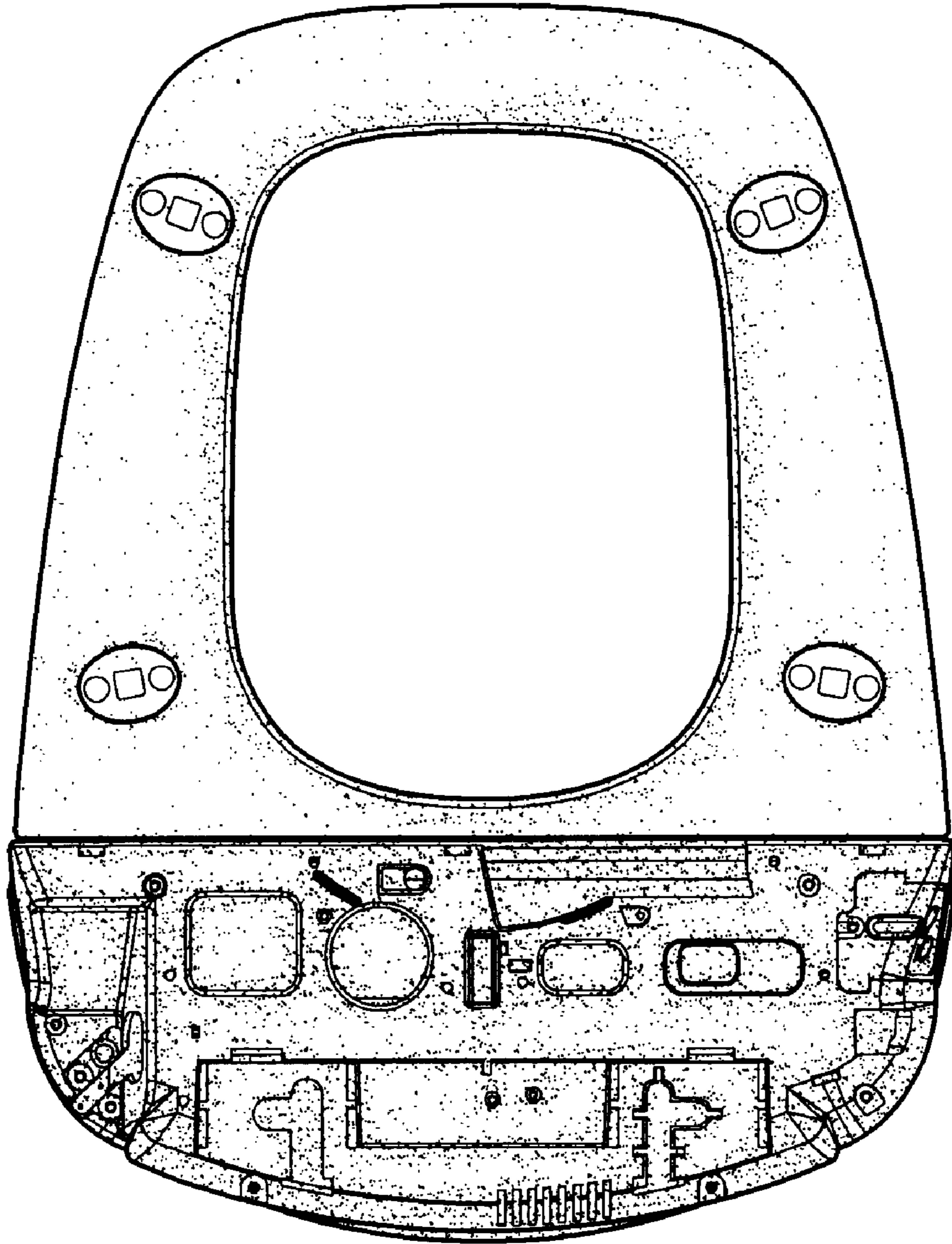

FIG. 7