

US00D508948S

(12) **United States Design Patent** (10) **Patent No.:** **US D508,948 S**  
**Metaxatos et al.** (45) **Date of Patent:** **\*\* Aug. 30, 2005**

(54) **MARKER**  
 (75) Inventors: **Paul Metaxatos**, Brookline, MA (US);  
**Steffen Koury**, Chelsea, MA (US)  
 (73) Assignee: **Berol Corporation**, Freeport, IL (US)  
 (\*\*) Term: **14 Years**

D418,872 S 1/2000 Leibeck ..... D19/50  
 D427,240 S 6/2000 Gruosi ..... D19/47  
 D456,041 S 4/2002 Cooper et al. .... D19/43  
 D461,204 S 8/2002 Klefbom ..... D19/36  
 D461,500 S 8/2002 Cooper et al. .... D19/43  
 D490,849 S 6/2004 Katami ..... D19/49  
 D498,258 S \* 11/2004 Song ..... D19/43

(21) Appl. No.: **29/213,349**  
 (22) Filed: **Sep. 16, 2004**

**Related U.S. Application Data**

(63) Continuation of application No. 29/169,110, filed on Oct. 15, 2002, now abandoned.  
 (51) **LOC (8) Cl.** ..... **19-06**  
 (52) **U.S. Cl.** ..... **D19/43; D19/47; D19/56**  
 (58) **Field of Search** ..... D19/35, 36, 41-51,  
 D19/53-58, 81-85; 401/6, 7, 88, 98, 196,  
 198, 202, 213, 243-261, 262; 24/10 R,  
 11 R, 11 P, 11 PP, 11 F, 11 M

(56) **References Cited**

**U.S. PATENT DOCUMENTS**

D139,904 S 1/1945 Baff ..... D19/48  
 D182,925 S 5/1958 Ribas ..... D19/48  
 D284,774 S 7/1986 Ludvig et al. .... D19/49  
 D295,537 S 5/1988 Davidson et al. .... D19/43  
 D325,931 S 5/1992 Sekiguchi ..... D19/43  
 D329,253 S 9/1992 Sekiguchi ..... D19/43  
 D340,947 S 11/1993 Tu ..... D19/43  
 D342,087 S 12/1993 Mear et al. .... D19/36  
 5,308,178 A \* 5/1994 Jiang ..... 401/202  
 D369,184 S 4/1996 Collins ..... D19/51  
 D413,925 S 9/1999 Reichmann ..... D19/36

**OTHER PUBLICATIONS**

Undated photograph of Sharpie Twin Tip marker.  
 Undated photograph of Sharpie Super Twin Tip marker.  
 Undated photograph of Sharpie Chisel Tip marker.  
 Undated photograph of Sharpie Fine Point marker.

\* cited by examiner

*Primary Examiner*—Martie K. Holtje  
 (74) *Attorney, Agent, or Firm*—Marshall, Gerstein & Borun  
 LLP

(57) **CLAIM**

The ornamental design for a “marker,” as shown and described.

**DESCRIPTION**

FIG. 1 is a right-side perspective view of a marker showing our new design;  
 FIG. 2 is a right-side elevational view of the marker of FIG. 1;  
 FIG. 3 is a left-side elevational view of the marker of FIG. 1;  
 FIG. 4 is a front view of the marker of FIG. 1;  
 FIG. 5 is a rear view of the marker of FIG. 1;  
 FIG. 6 is a bottom plan view of the marker of FIG. 1; and,  
 FIG. 7 is a top plan view of the marker of FIG. 1.

**1 Claim, 4 Drawing Sheets**

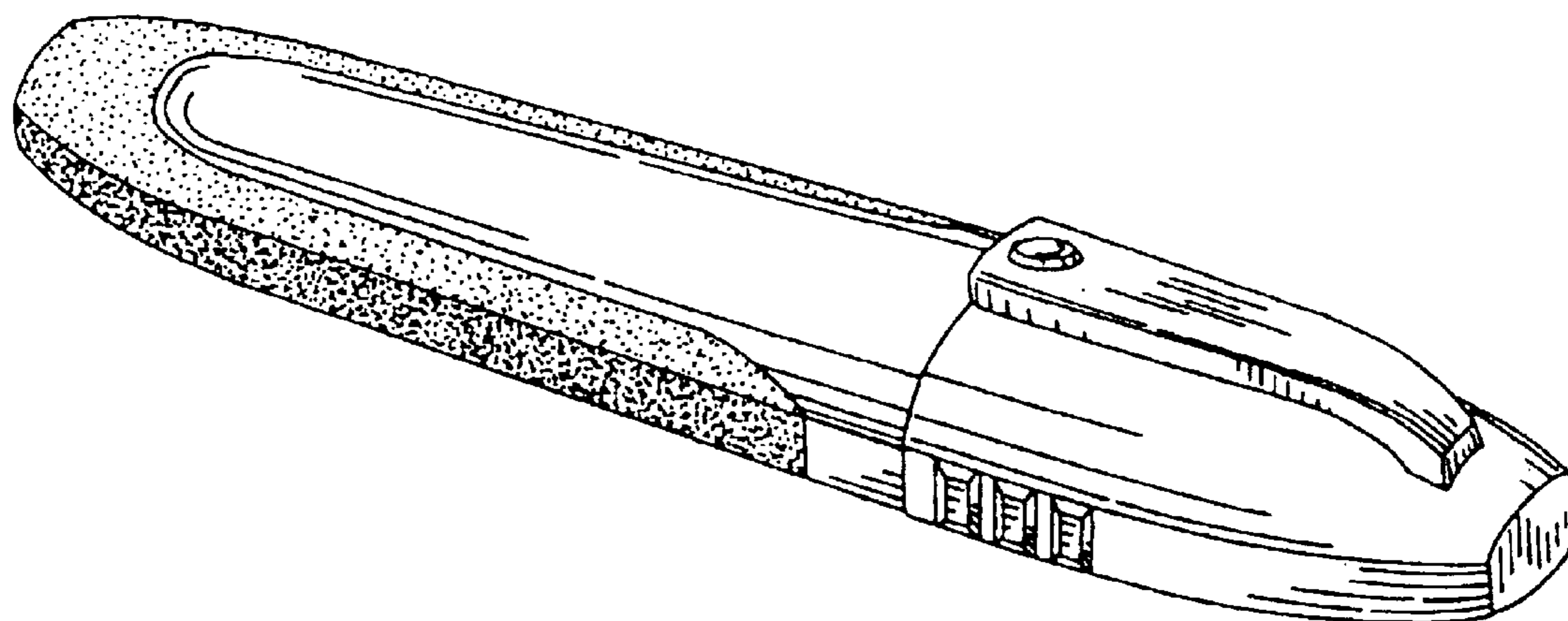

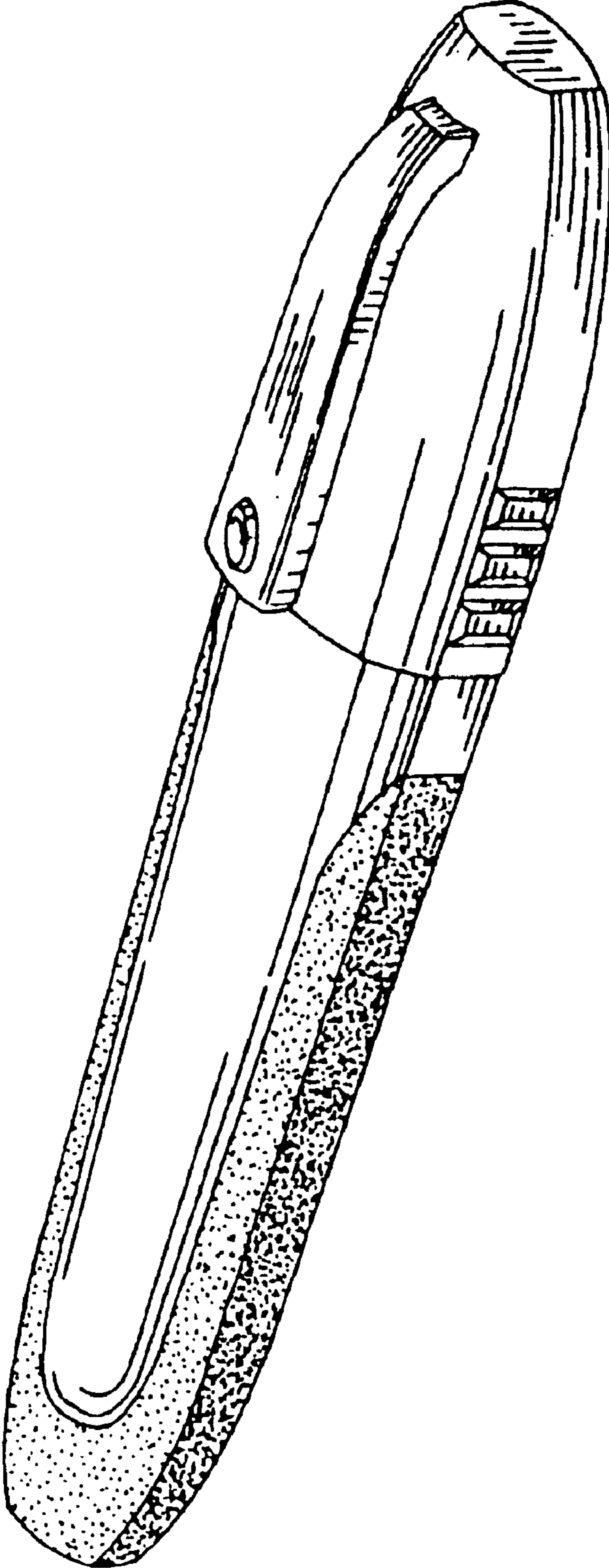

FIG. 1

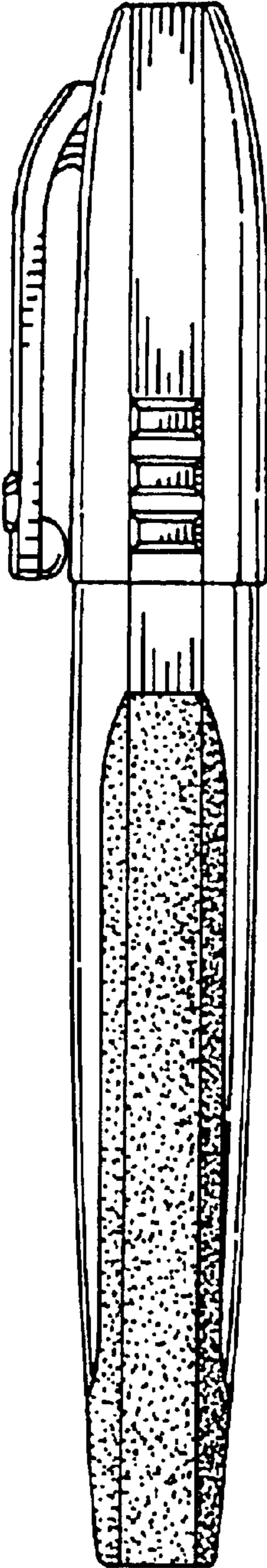

FIG. 2

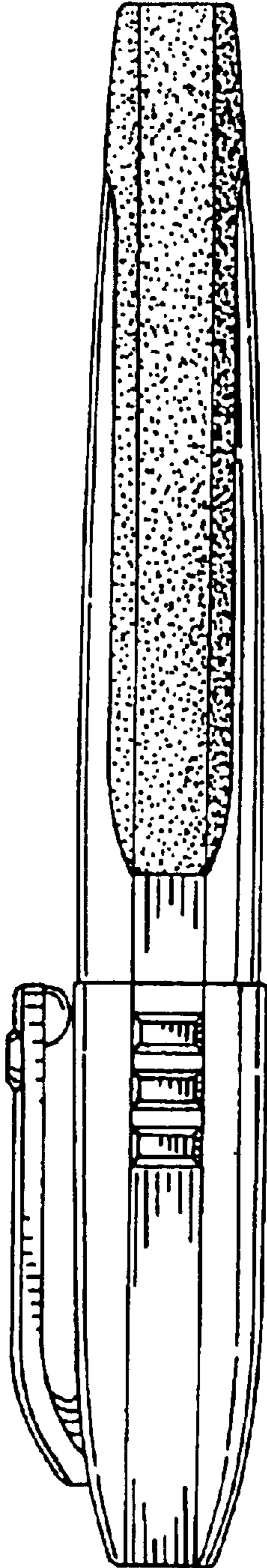

FIG. 3

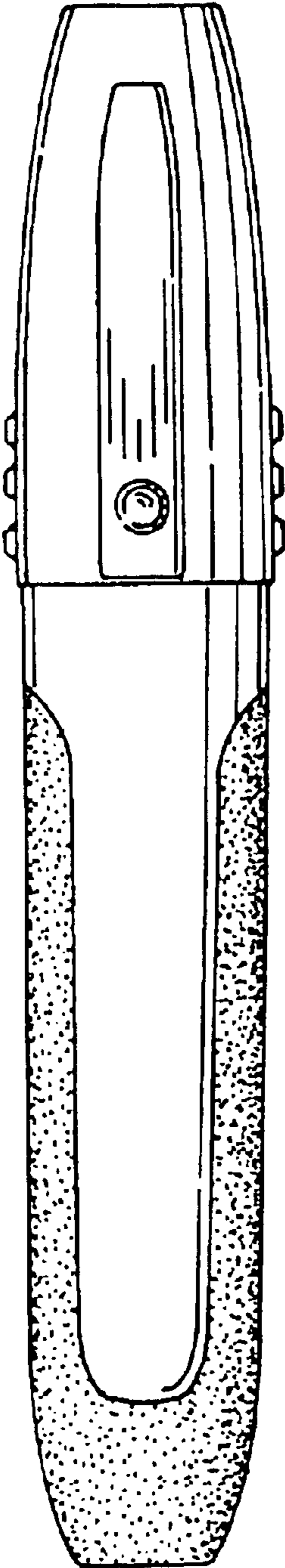

FIG. 4

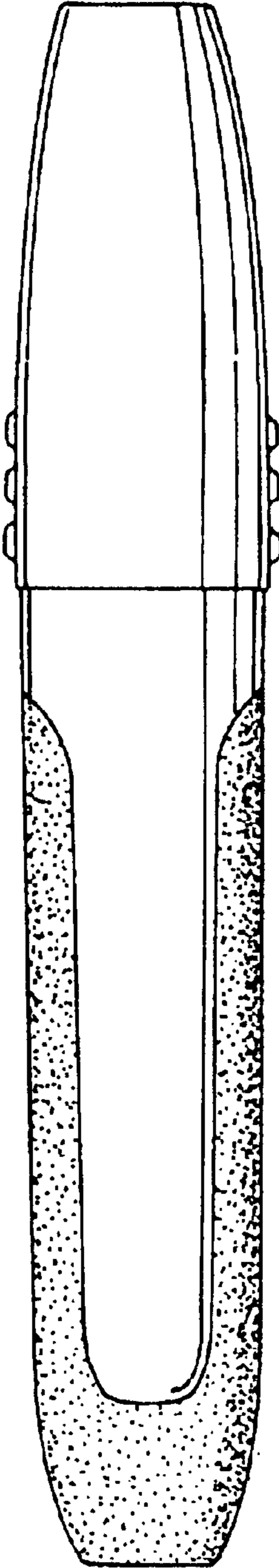

FIG. 5

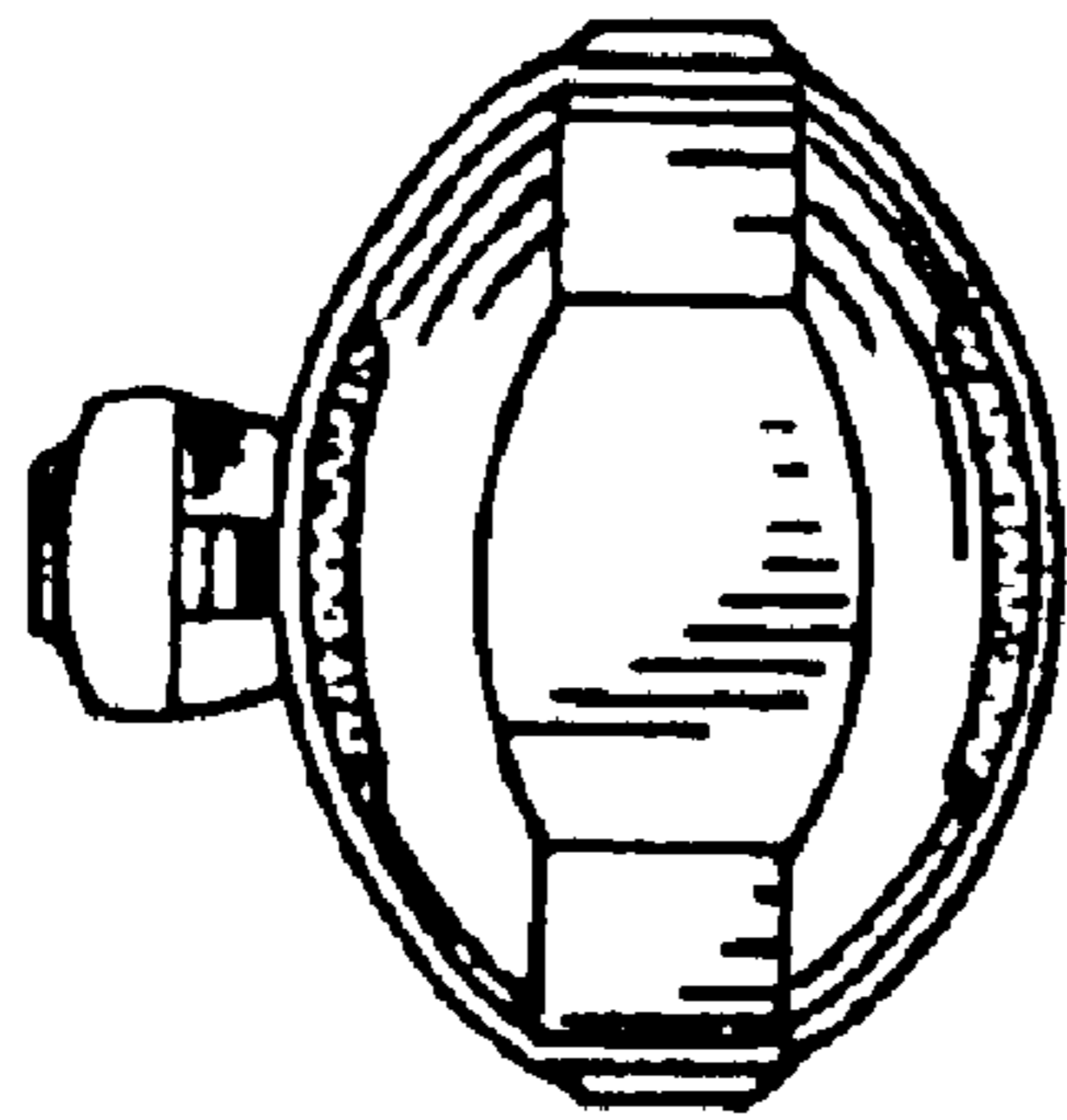

FIG. 6

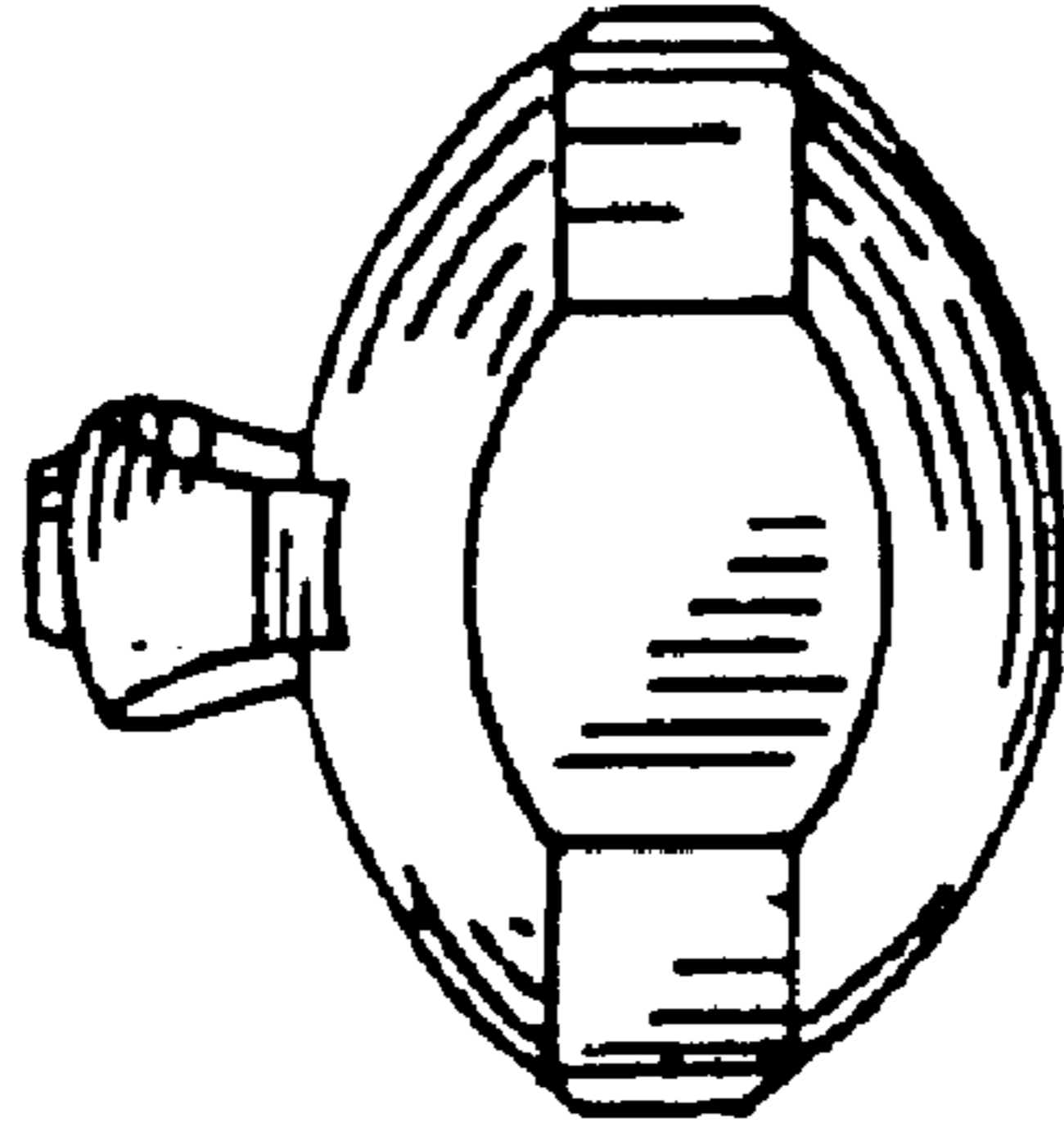

FIG. 7