

US00D508906S

(12) **United States Design Patent** (10) **Patent No.:** **US D508,906 S**
Tajima (45) **Date of Patent:** **** Aug. 30, 2005**

(54) **VOICE RECORDING AND REPRODUCING APPARATUS**

(75) Inventor: **Kenji Tajima, Hachioji (JP)**

(73) Assignee: **Olympus Corporation, Tokyo (JP)**

(**) Term: **14 Years**

(21) Appl. No.: **29/198,582**

(22) Filed: **Jan. 30, 2004**

(30) **Foreign Application Priority Data**

Sep. 9, 2003 (JP) 2003-026305

(51) **LOC (8) Cl.** **14-01**

(52) **U.S. Cl.** **D14/167**

(58) **Field of Search** D14/167, 154,
D14/168, 188, 156, 160, 161, 162, 163,
164, 165, 192; 455/350, 351

(56) **References Cited**

U.S. PATENT DOCUMENTS

- D314,715 S * 2/1991 Nelson et al. D10/78
- 5,166,599 A * 11/1992 Hochreuther et al. 324/115
- 5,243,275 A * 9/1993 Nakazawa et al. 324/110
- 5,442,337 A * 8/1995 Hwang 340/635
- D365,031 S * 12/1995 Kim D10/78
- D369,306 S * 4/1996 Fisher D10/78
- D378,589 S * 3/1997 Ellermeier D14/154
- 5,619,129 A * 4/1997 Kamiya 324/115
- D385,808 S * 11/1997 Kim D10/78
- D390,139 S * 2/1998 Tomiyama et al. D10/78
- D393,262 S * 4/1998 Shimatsu et al. D14/154
- D395,252 S * 6/1998 Nelson et al. D10/78
- D401,520 S * 11/1998 Beha D10/78
- D401,521 S * 11/1998 Wrisley et al. D10/78
- D404,664 S * 1/1999 Wrisley D10/78
- D411,539 S * 6/1999 Nagai et al. D14/218
- D412,450 S * 8/1999 McCain D10/78
- D414,125 S * 9/1999 Chen D10/78
- D423,384 S * 4/2000 Beha D10/78
- D424,456 S * 5/2000 Hoofnagle et al. D10/78
- D427,090 S * 6/2000 Washburn et al. D10/78

- D435,797 S * 1/2001 Hoofnagle et al. D10/78
- D446,463 S * 8/2001 Chang D10/78
- D446,735 S * 8/2001 McCain D10/78
- D458,551 S * 6/2002 Malawista D10/78
- D472,828 S * 4/2003 Chang D10/78
- D473,205 S * 4/2003 Tajima D14/167
- D474,414 S * 5/2003 Ikeda et al. D10/78
- D491,084 S * 6/2004 Olson D10/78
- 6,769,603 B2 * 8/2004 Nagai et al. 235/375
- D501,145 S * 1/2005 Bras et al. D10/78
- D501,416 S * 2/2005 Bras et al. D10/78
- 2004/0217870 A1 * 11/2004 Hodgen 340/574

OTHER PUBLICATIONS

Olympus VN 240 Voice Recorder <http://www.wholesale-digital.co.za/olsvn240.htm>, Mar. 4, 2005.*

Olympus VN 120 Voice Recorder http://www.thebestthings.com/voicerecorders/olympus_vn120.htm, Mar. 4, 2005.*

* cited by examiner

Primary Examiner—Joel A. Sincavage

Assistant Examiner—Austin Murphy

(74) *Attorney, Agent, or Firm*—Hogan & Hartson LLP

(57) **CLAIM**

The ornamental design for a voice recording and reproducing apparatus, as shown and described.

DESCRIPTION

FIG. 1 is a perspective view showing a voice recording and reproducing apparatus as our novel design, as seen obliquely from the front upper left side thereof;

FIG. 2 is a perspective view thereof, as seen obliquely from the rear lower left side thereof;

FIG. 3 is a front view thereof;

FIG. 4 is a rear view thereof;

FIG. 5 is a top plan view thereof;

FIG. 6 is a bottom plan view thereof;

FIG. 7 is a right side view thereof;

FIG. 8 is a left side view thereof; and,

FIG. 9 is a cross-sectional view taken along A—A line in FIG. 3.

1 Claim, 6 Drawing Sheets

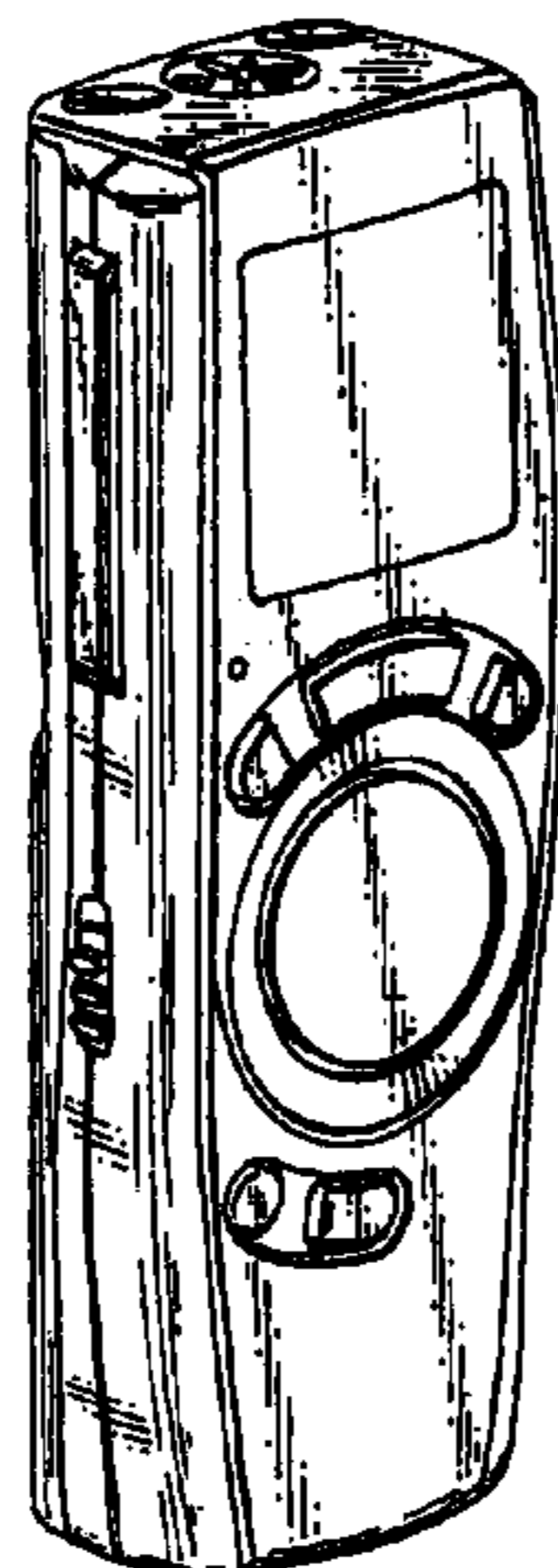

FIG. 1

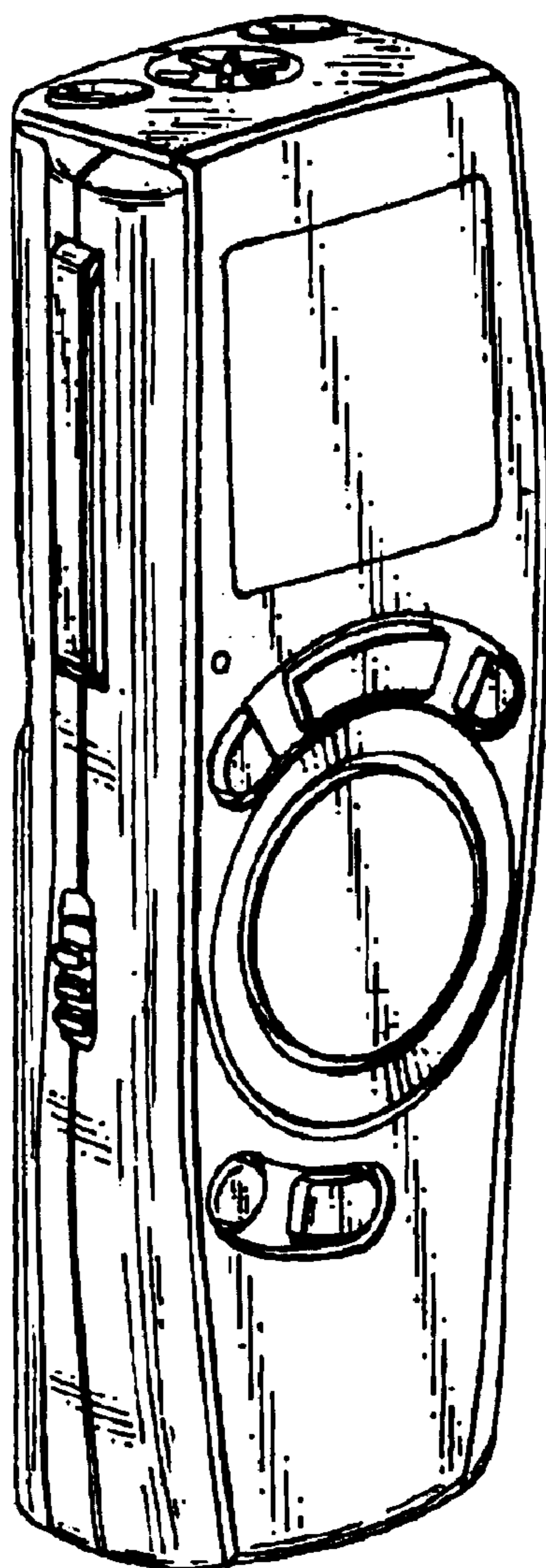

FIG.2

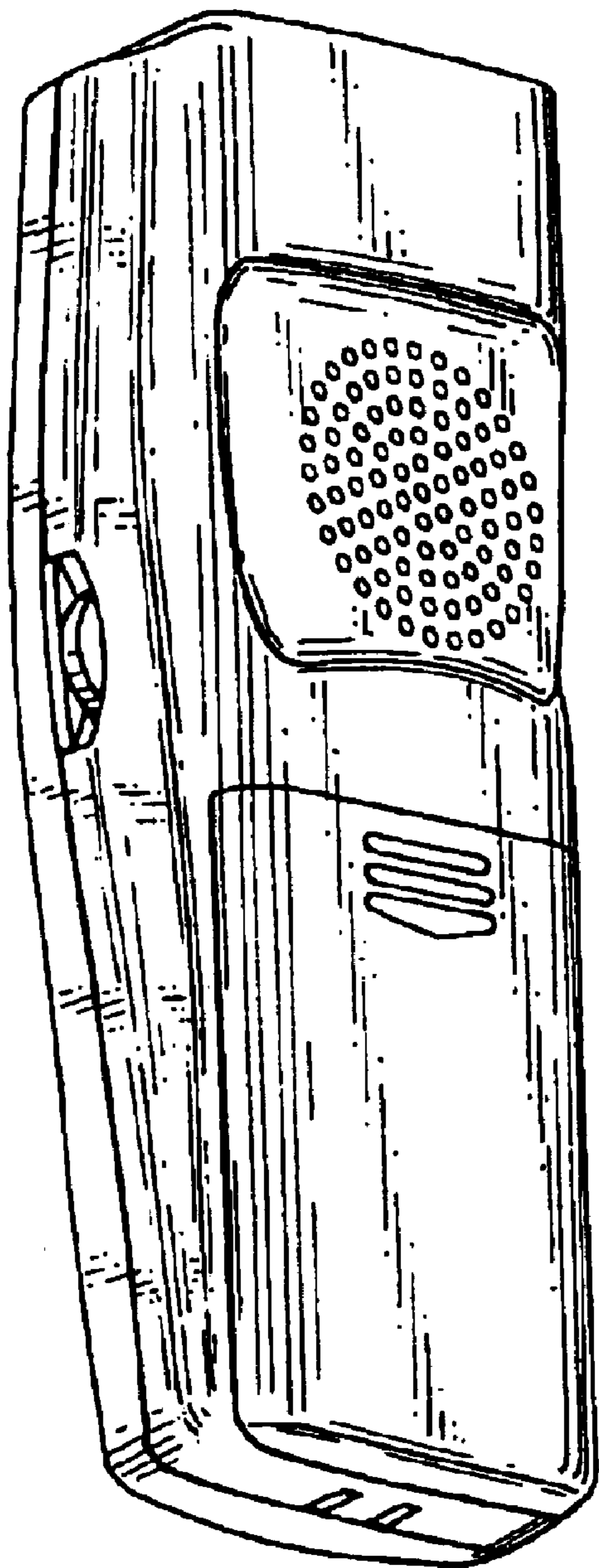

FIG.3

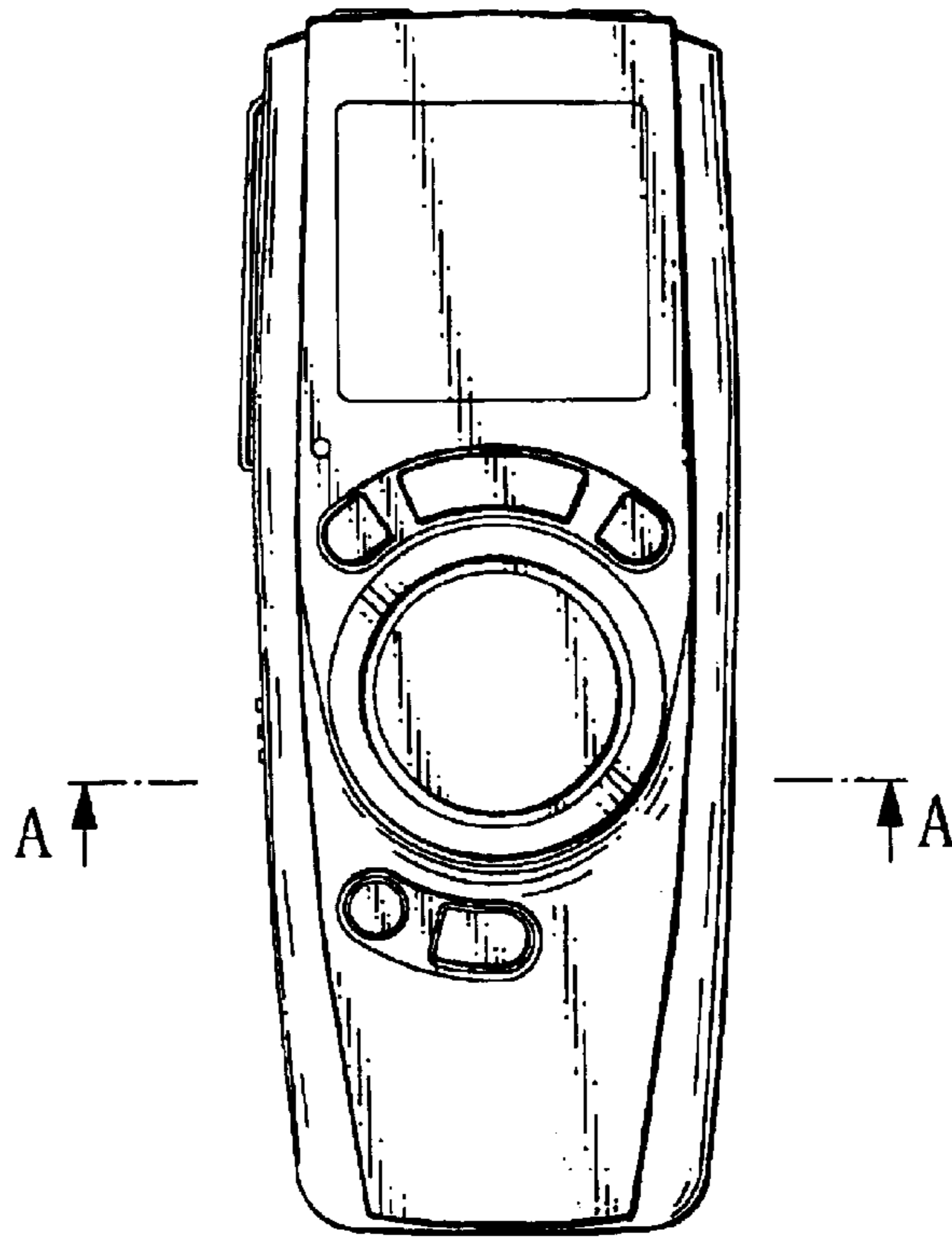

FIG.4

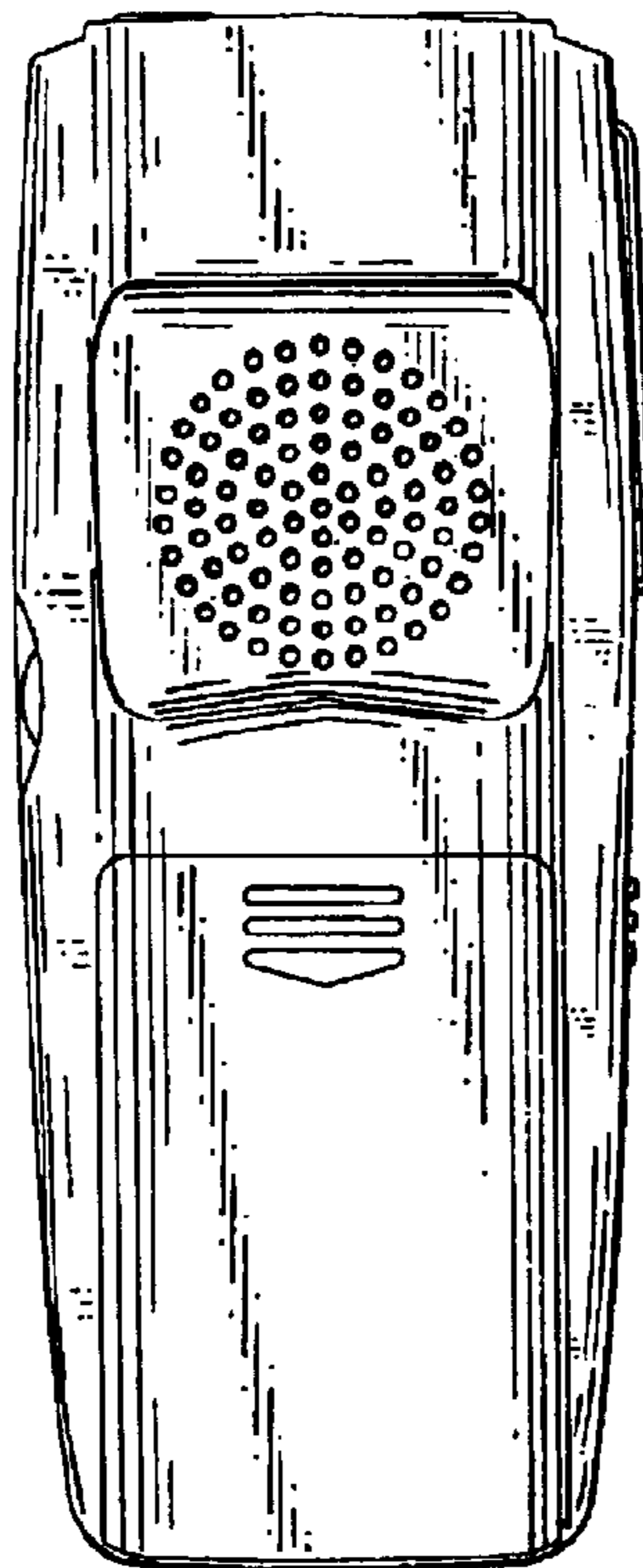

FIG.5

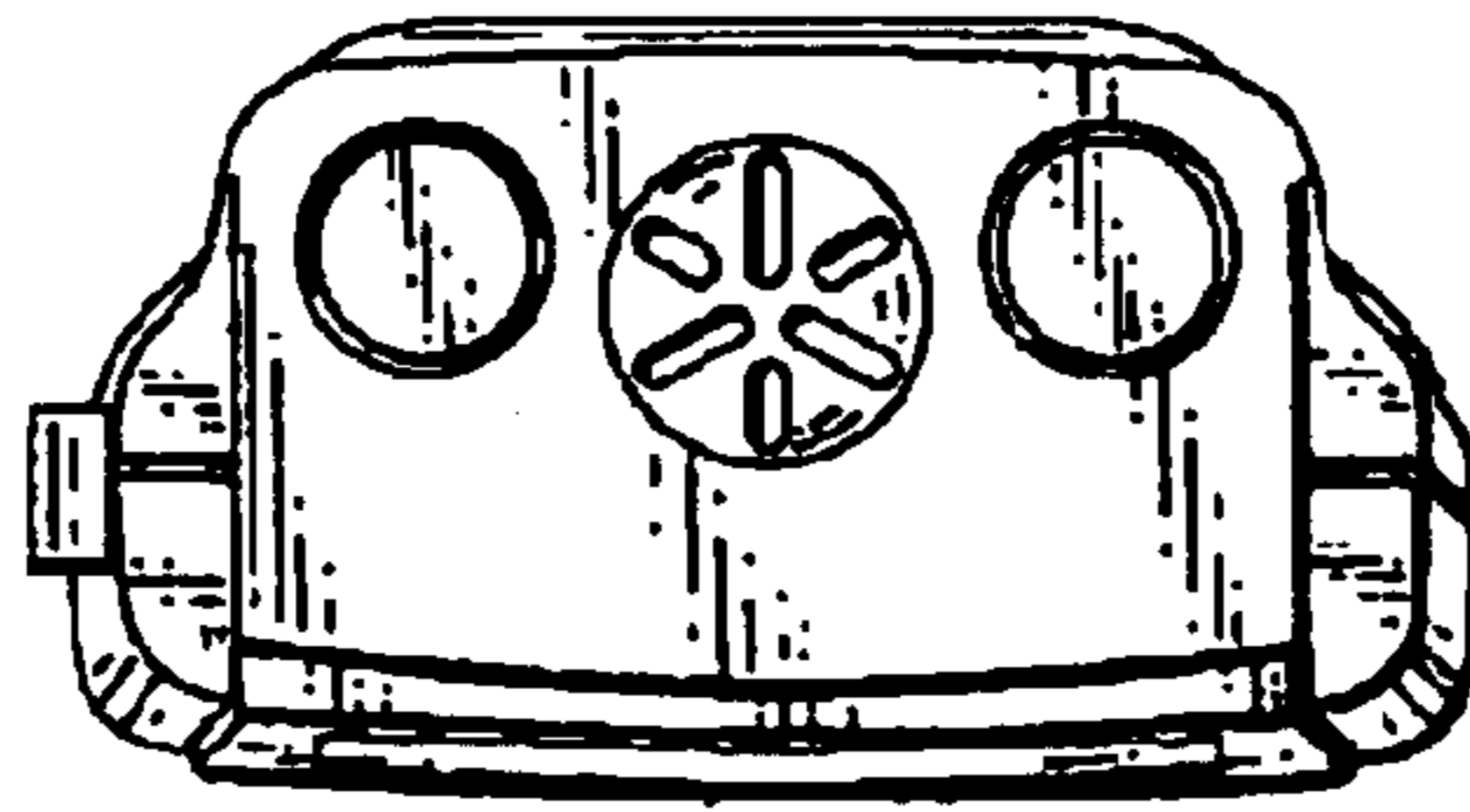

FIG.6

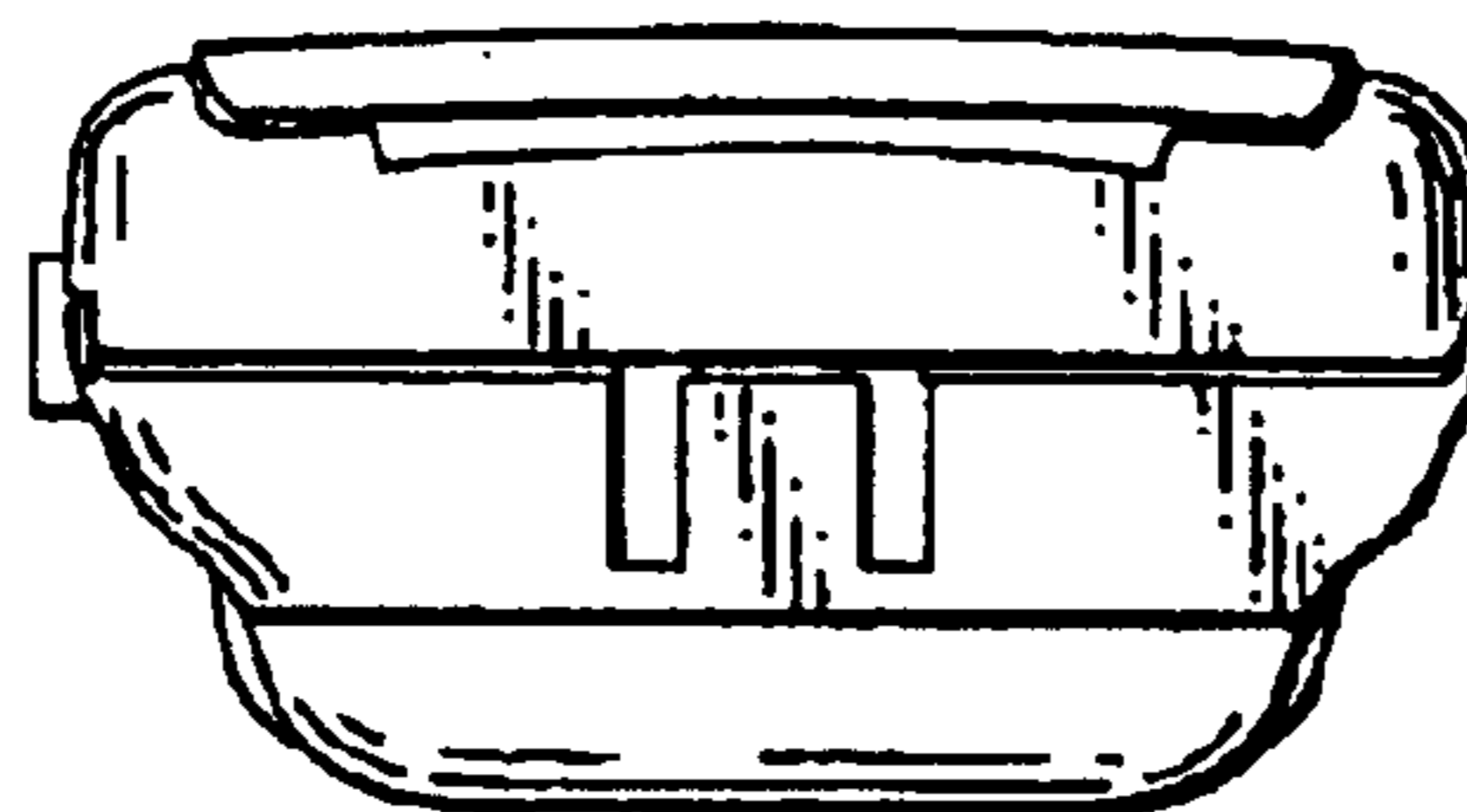

FIG.7

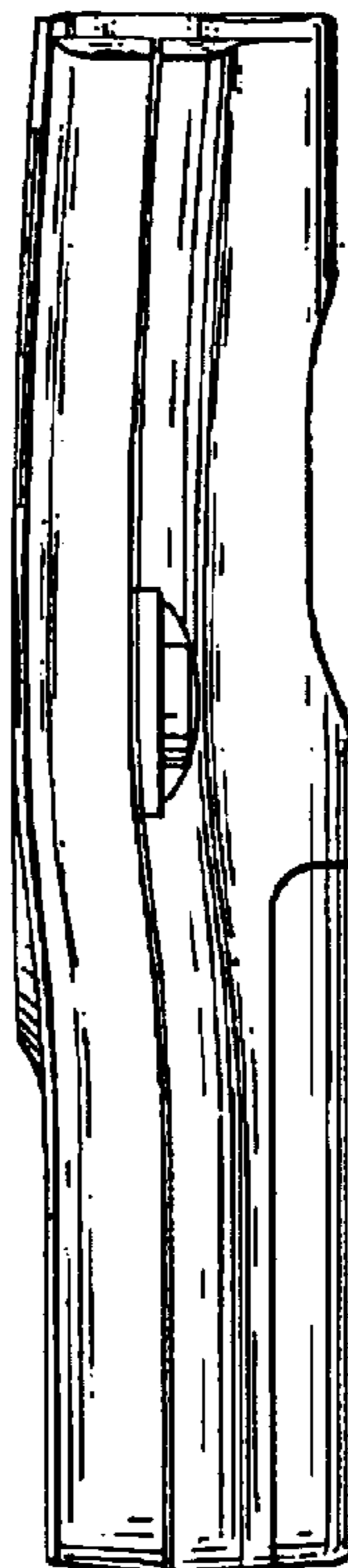

FIG.8

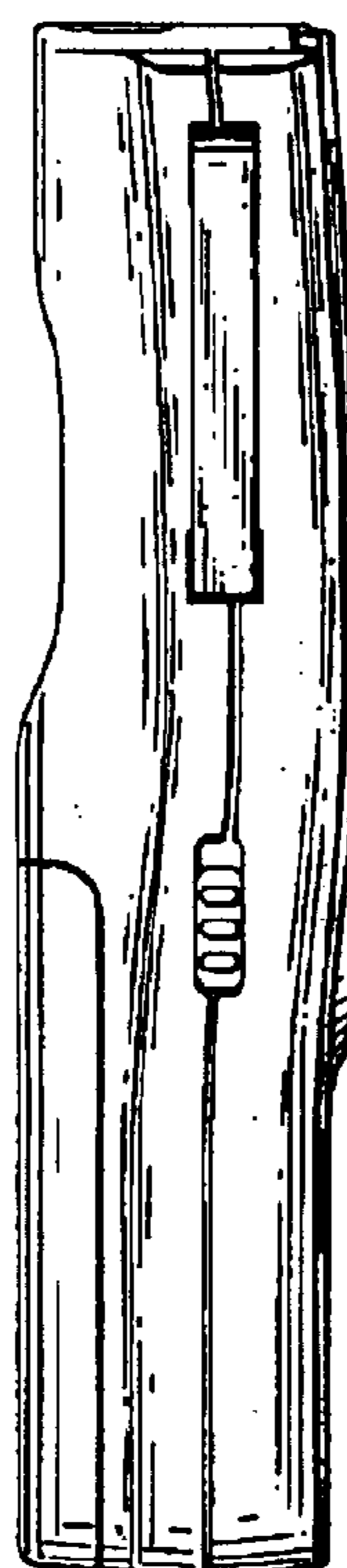

FIG. 9

