

US00D508878S

(12) **United States Design Patent**
Pedone et al.

(10) **Patent No.:** **US D508,878 S**

(45) **Date of Patent:** **** Aug. 30, 2005**

(54) **MOTOR SCOOTER**

(75) Inventors: **Gianni Pedone**, Palermo (IT); **Daniele Ferrara**, Como (IT)

(73) Assignee: **Honda Motor Co., Ltd.**, Tokyo (JP)

(**) Term: **14 Years**

(21) Appl. No.: **29/200,824**

(22) Filed: **Mar. 5, 2004**

(30) **Foreign Application Priority Data**

Sep. 10, 2003 (JP) 2003-026443

(51) **LOC (8) Cl.** **12-11**

(52) **U.S. Cl.** **D12/110**

(58) **Field of Search** 180/229, 219,
180/220, 225; D12/110

(56) **References Cited**

U.S. PATENT DOCUMENTS

D331,553 S * 12/1992 Agnolucci D12/110

D482,638 S * 11/2003 Pedone D12/110

* cited by examiner

Primary Examiner—Alan P. Douglas

Assistant Examiner—Linda Brooks

(74) *Attorney, Agent, or Firm*—Arent Fox, PLLC

(57) **CLAIM**

The ornamental design for a motor scooter, as shown and described.

DESCRIPTION

FIG. 1 is a front view of a motor scooter showing our new design.

FIG. 2 is a rear view thereof.

FIG. 3 is a plan view thereof.

FIG. 4 is a bottom view thereof.

FIG. 5 is a right side view thereof.

FIG. 6 is a left side view thereof.

FIG. 7 is a front perspective view thereof seen from the right side.

FIG. 8 is a front perspective view thereof seen from the left side.

FIG. 9 is a rear perspective view thereof from the right side; and,

FIG. 10 is a rear perspective view thereof seen from the left side.

1 Claim, 5 Drawing Sheets

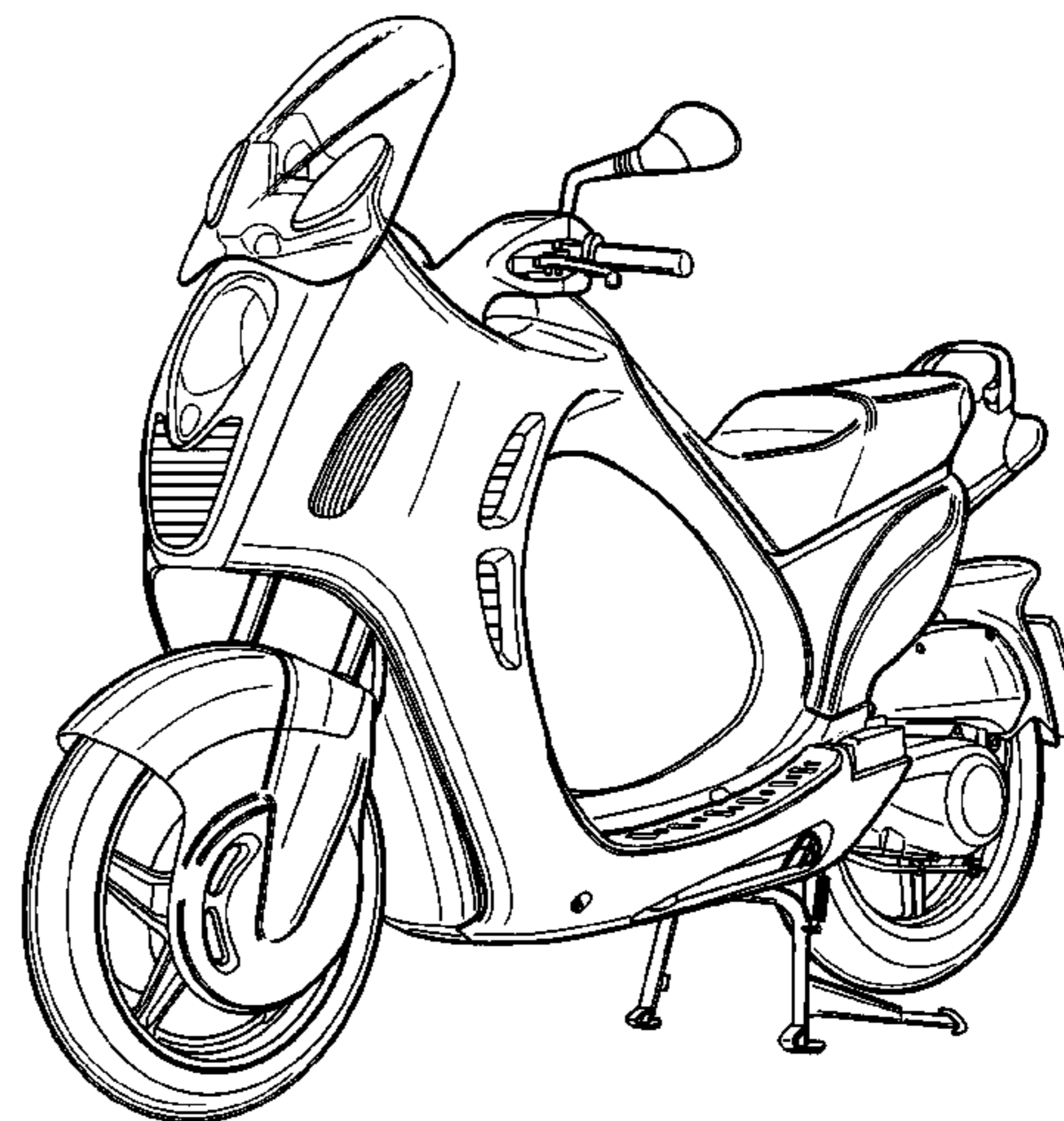
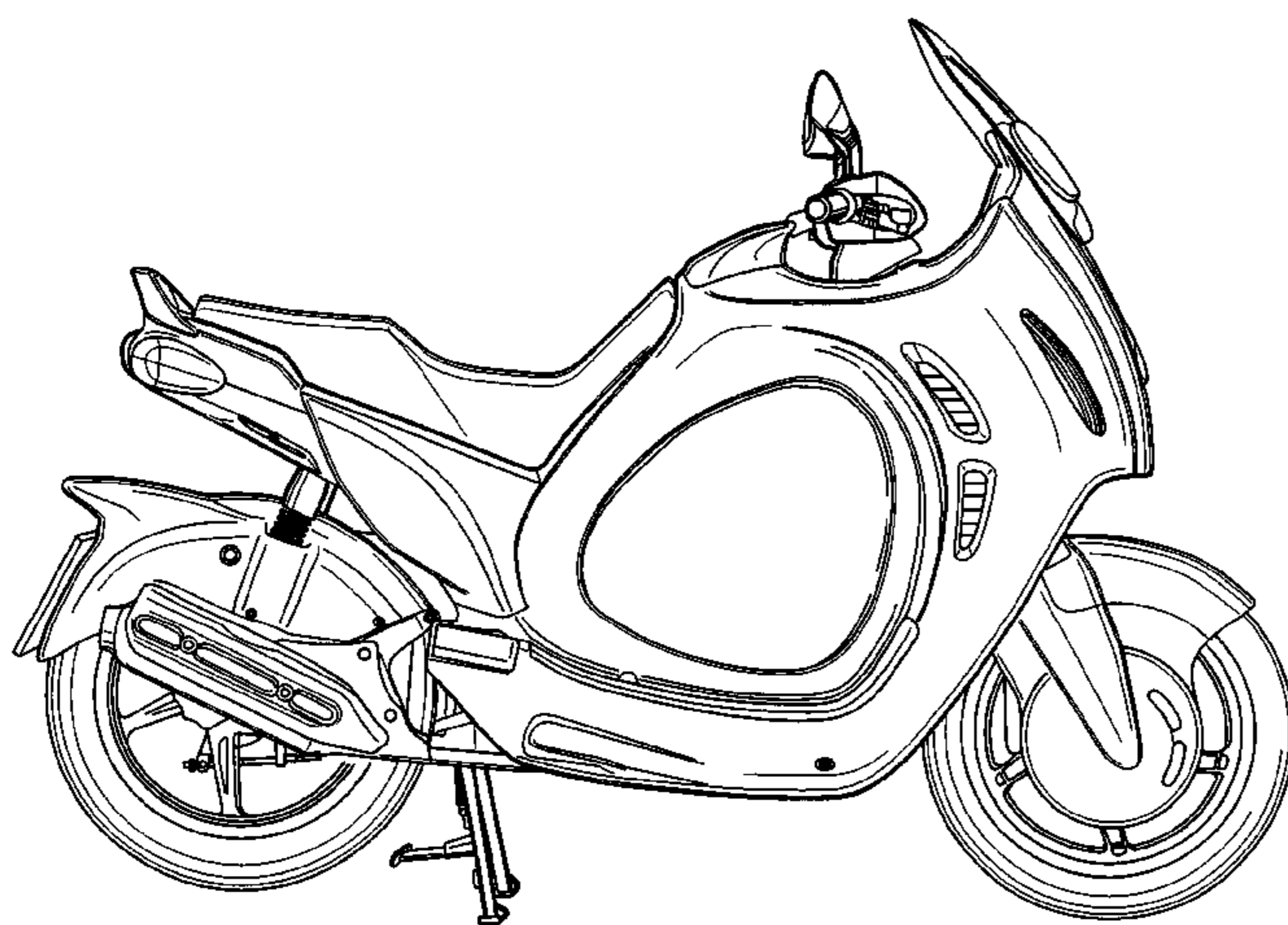

FIG.1

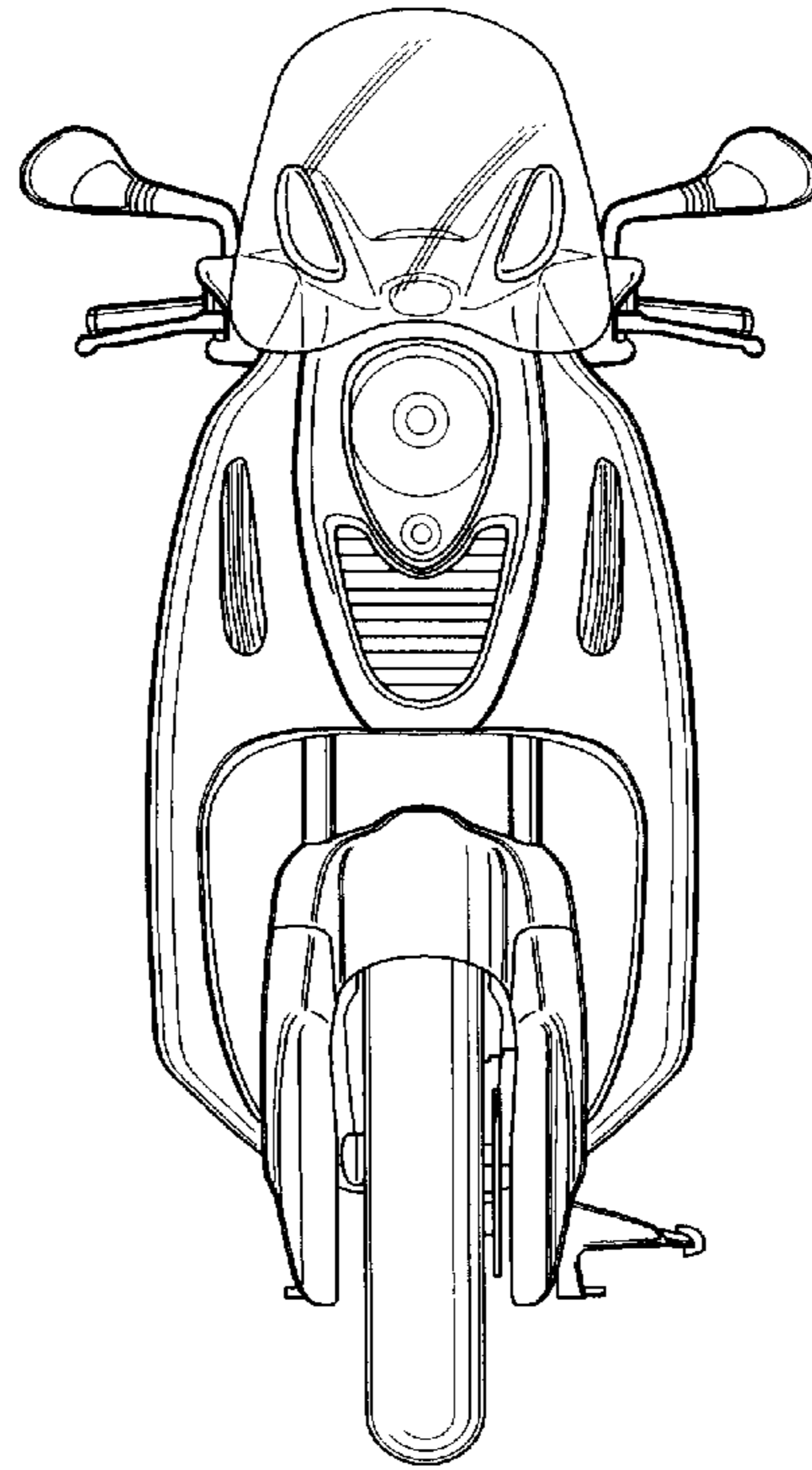

FIG.2

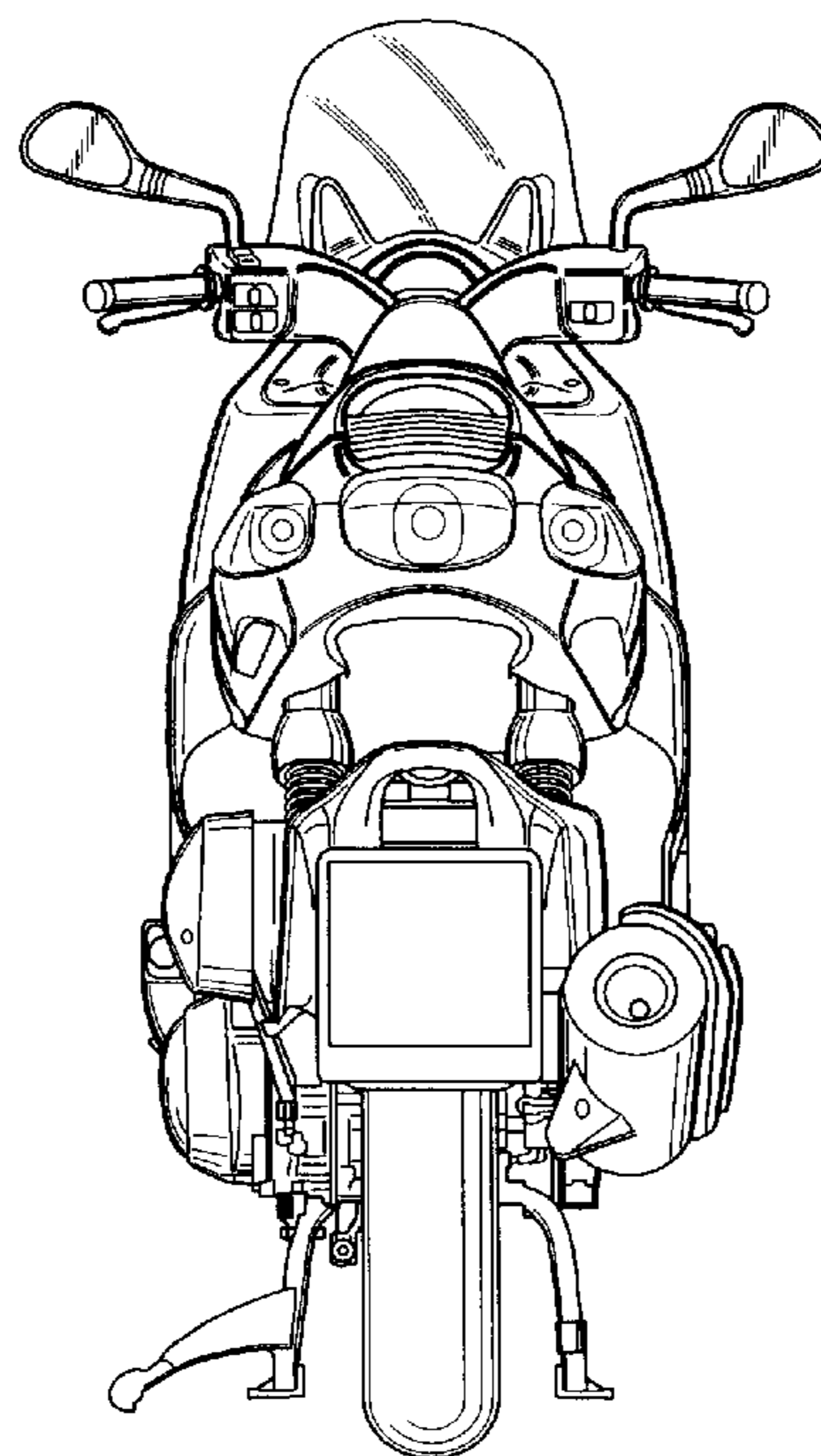

FIG.3

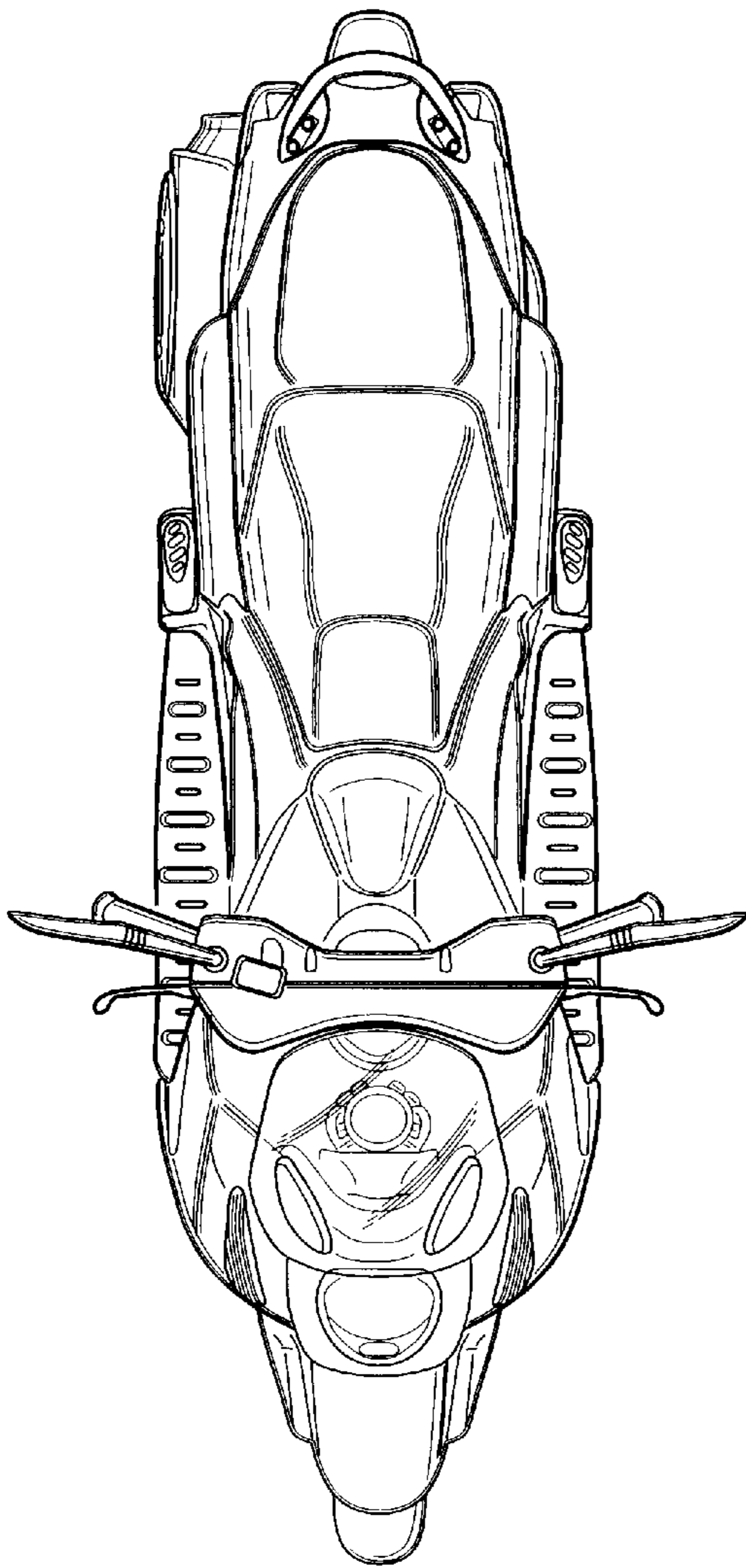

FIG.4

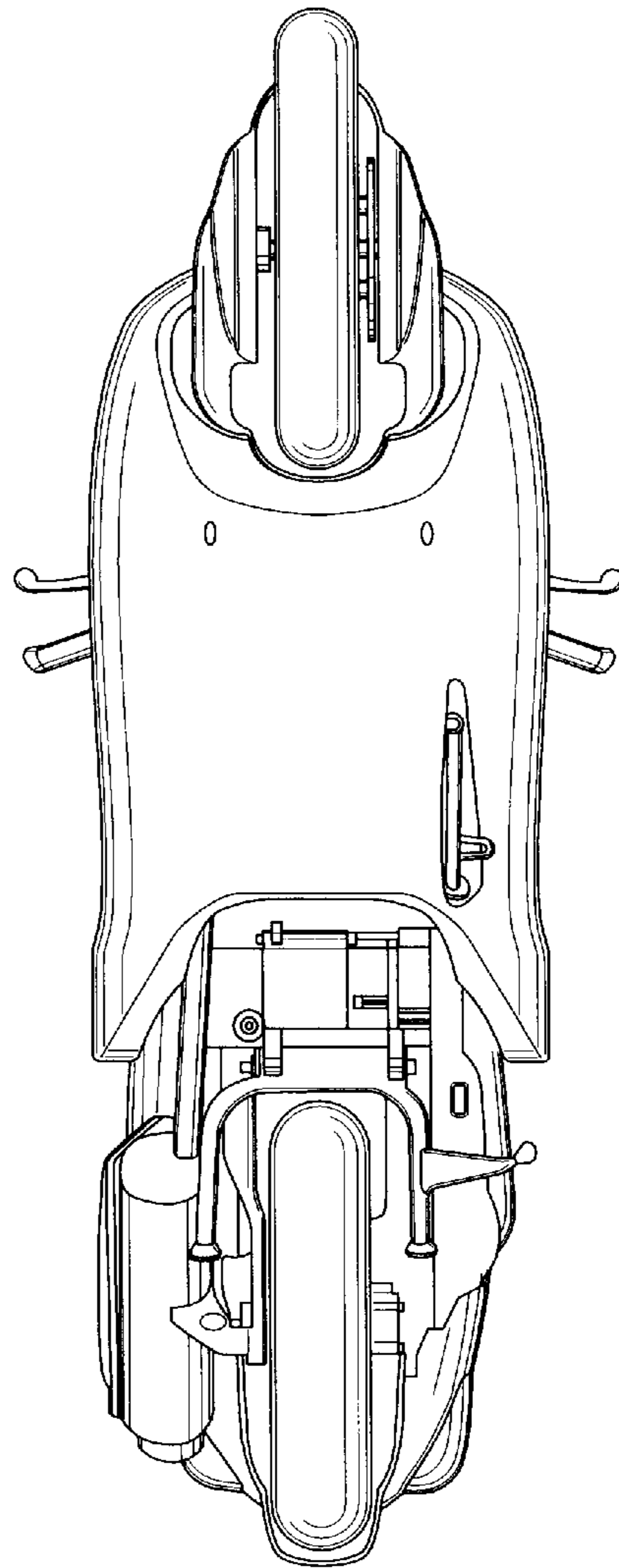

FIG.5

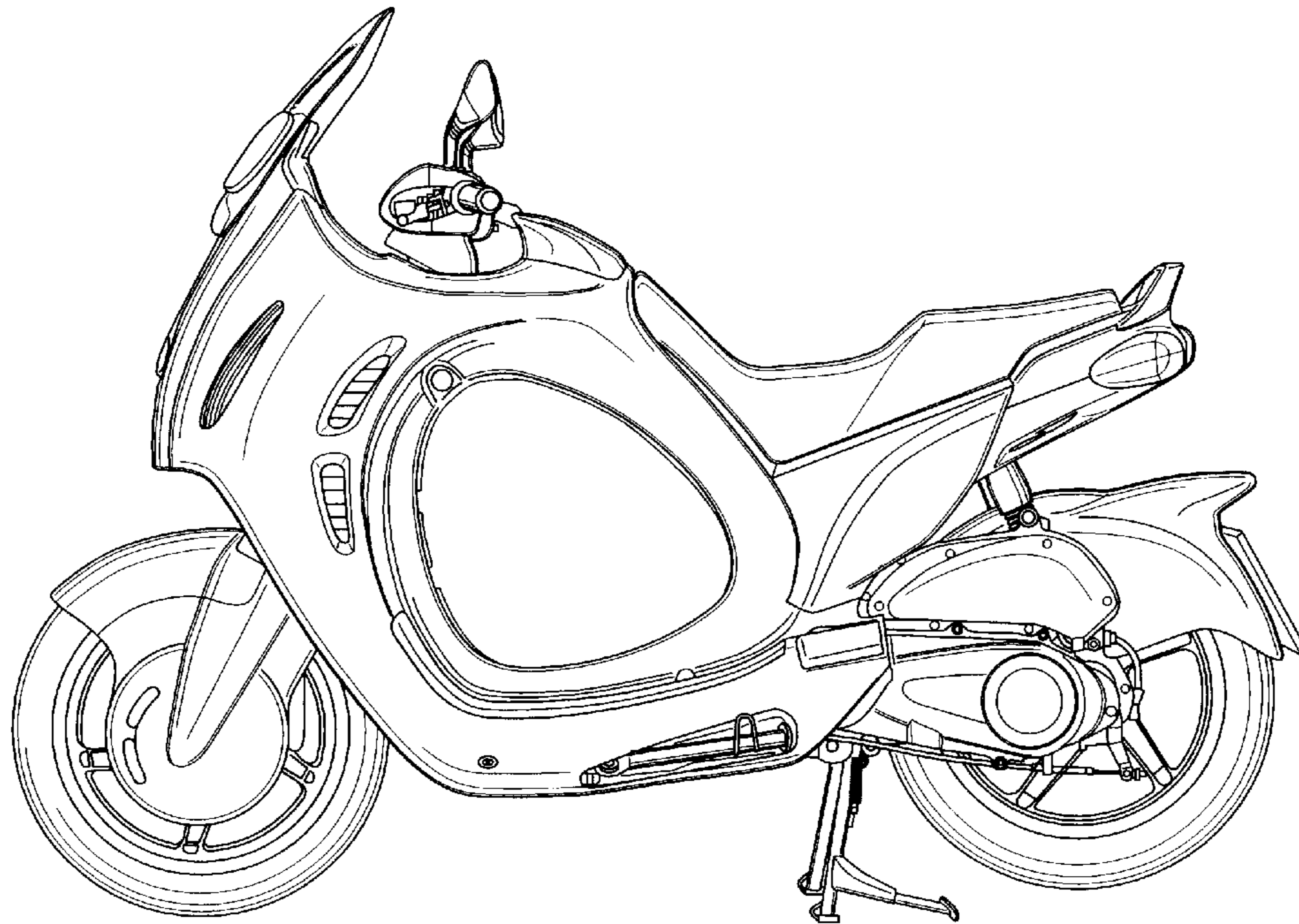

FIG.6

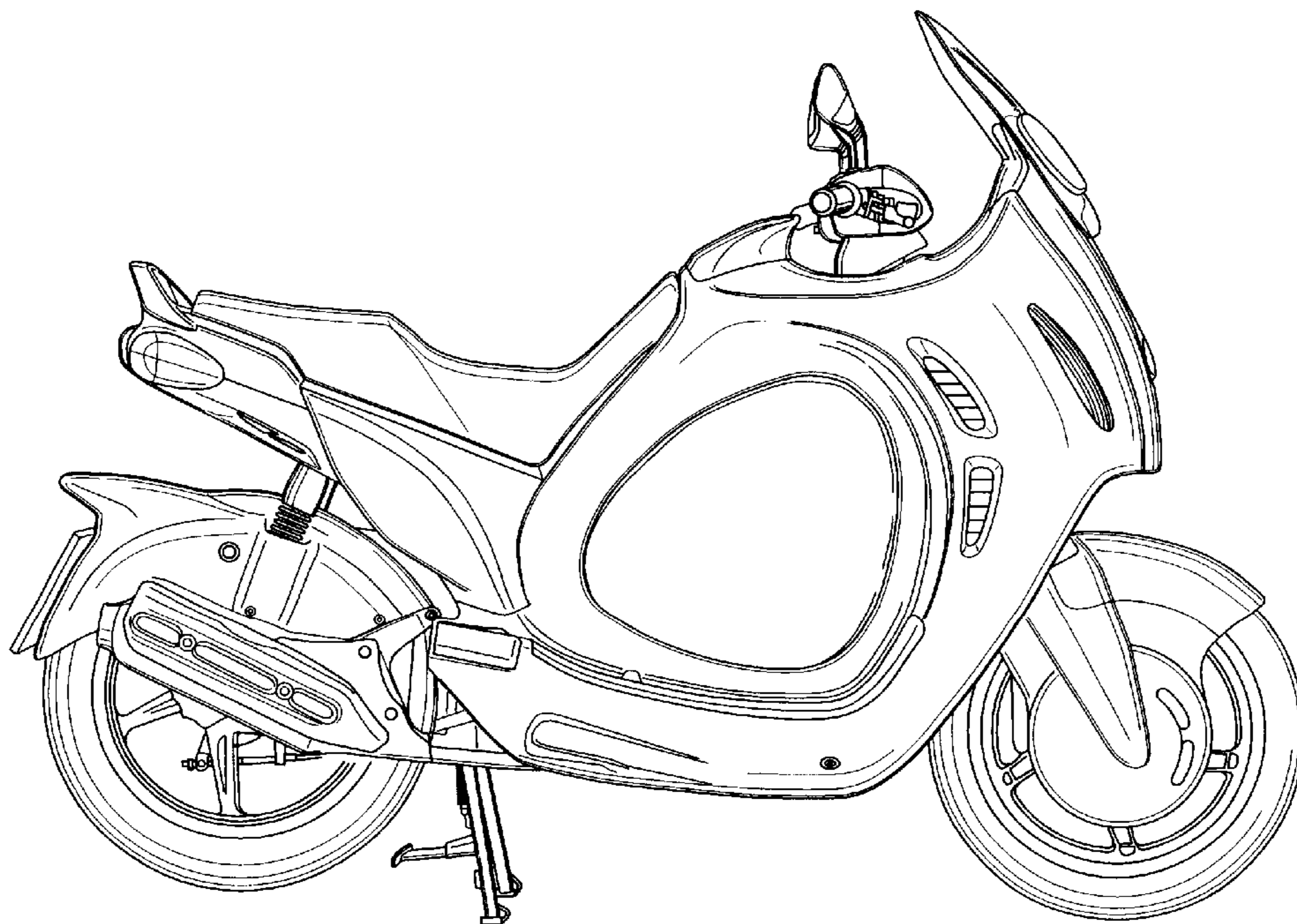

FIG.7

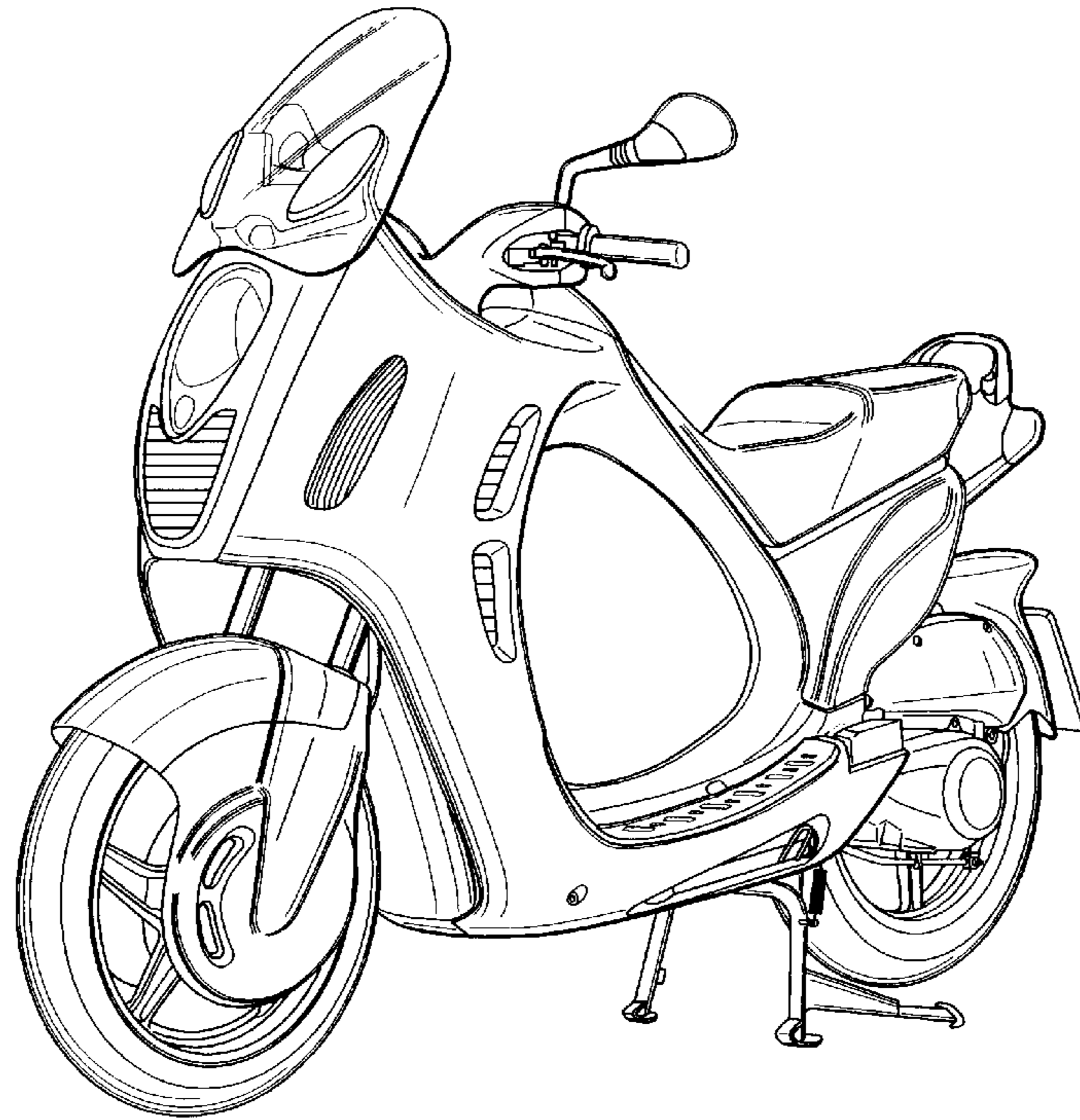

FIG.8

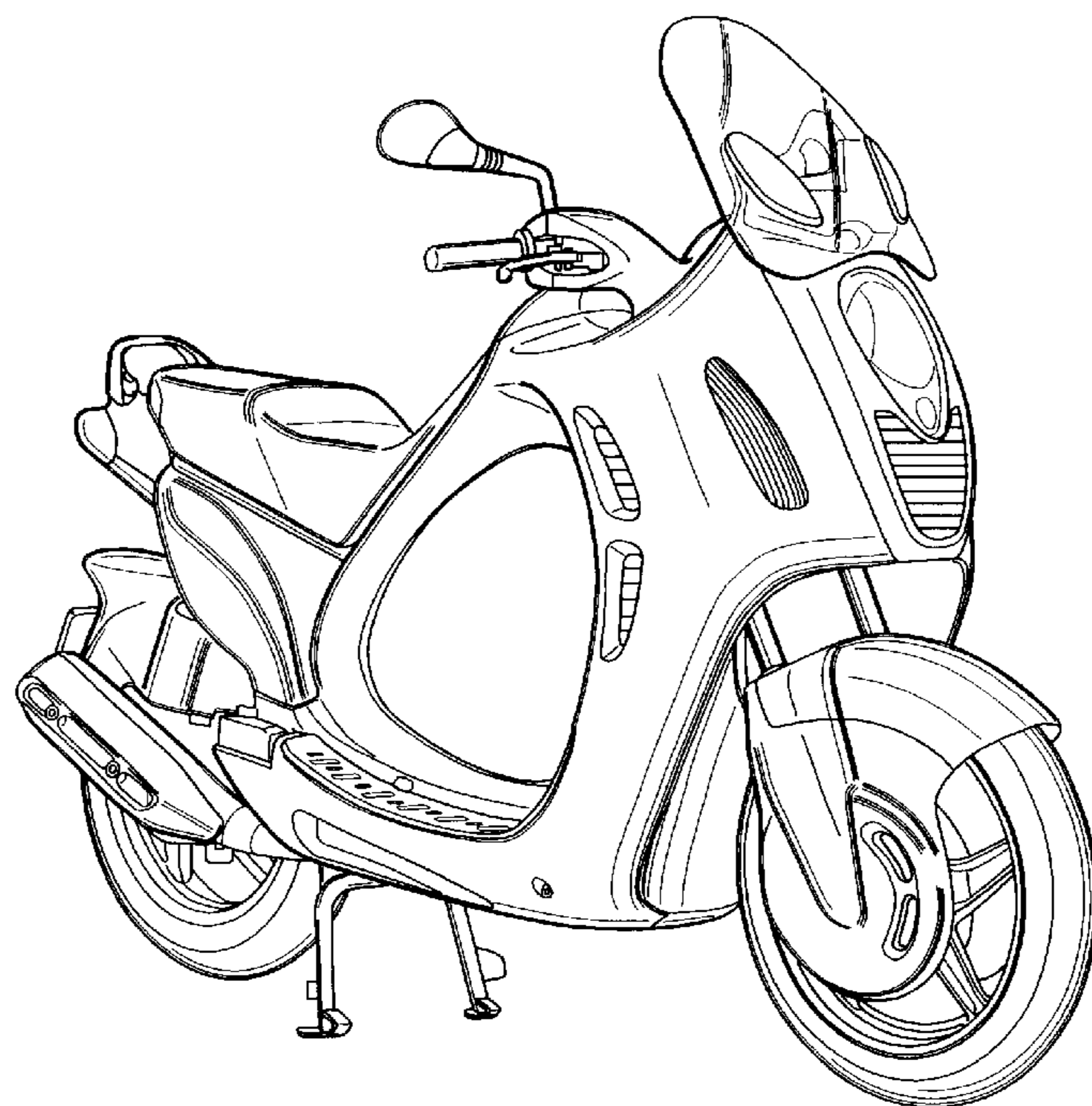

FIG.9

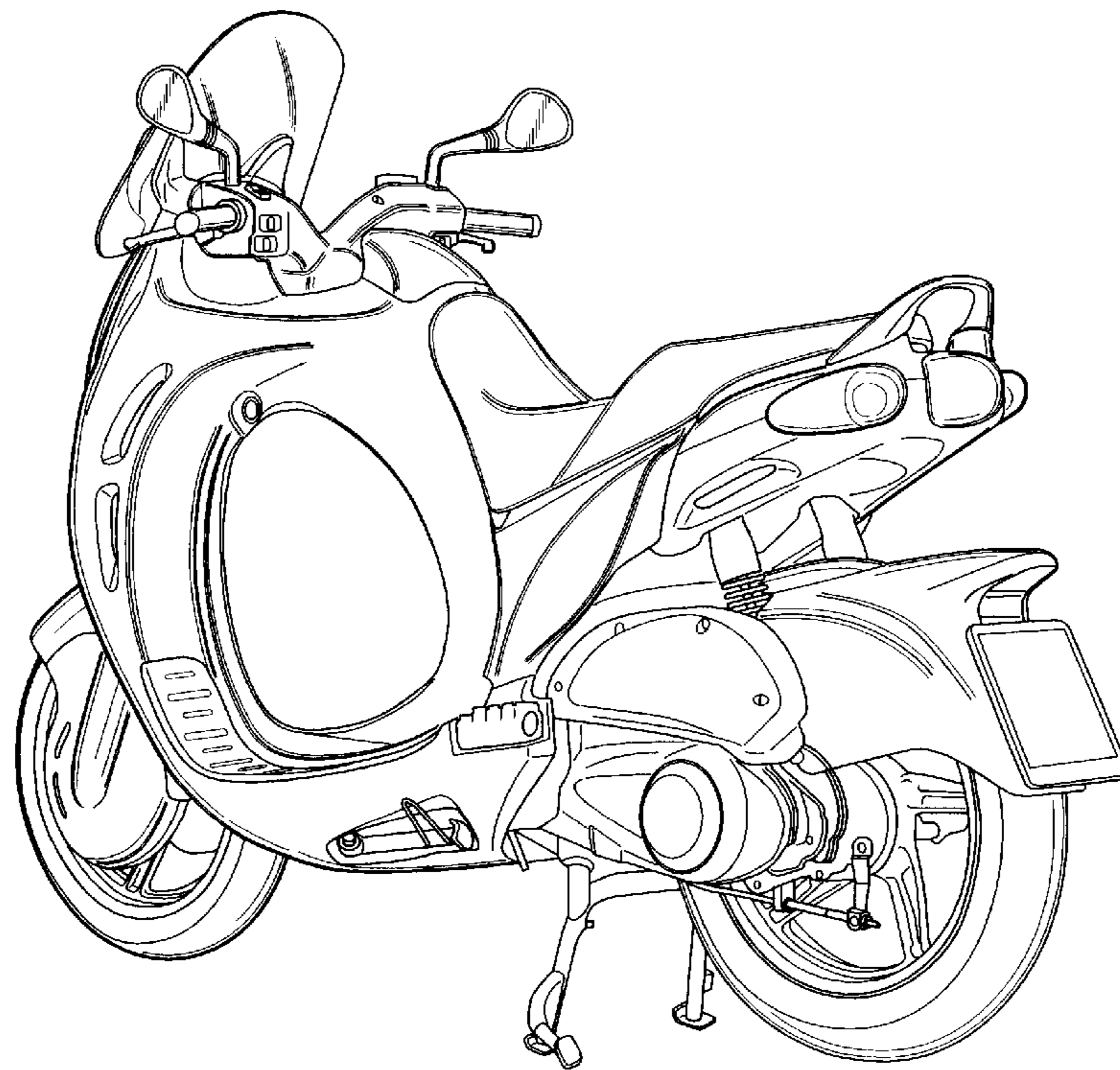

FIG.10

