

US00D508876S

(12) **United States Design Patent**
Kim et al.

(10) **Patent No.:** **US D508,876 S**
(45) **Date of Patent:** **** Aug. 30, 2005**

(54) **MOTOR VEHICLE AND/OR TOY REPLICA THEREOF**

LFS, Car Styling Magazine, Jan. 31, 2004, cover page.

* cited by examiner

(75) Inventors: **Jin Won Kim**, Newport Beach, CA (US); **Alexander Wen Shen**, Newport Beach, CA (US)

Primary Examiner—Melody N. Brown
(74) *Attorney, Agent, or Firm*—SAIDMAN DesignLaw Group

(73) Assignee: **Toyota Jidosha Kabushiki Kaisha (JP)**

(**) Term: **14 Years**

(57) **CLAIM**

(21) Appl. No.: **29/213,108**

The ornamental design for a motor vehicle and/or toy replica thereof, as shown and described.

(22) Filed: **Sep. 13, 2004**

(51) **LOC (8) Cl.** **12-08**

(52) **U.S. Cl.** **D12/92**

(58) **Field of Search** D12/90-92, 86;
D21/424, 433; 296/185

DESCRIPTION

FIG. 1 is a front perspective view of a motor vehicle and/or toy replica thereof showing our new design;

FIG. 2 is a rear perspective view thereof;

FIG. 3 is a right-side view thereof, with the left-side being a mirror image;

FIG. 4 is a top view thereof;

FIG. 5 is a front view thereof; and,

FIG. 6 is a rear view thereof.

(56) **References Cited**

U.S. PATENT DOCUMENTS

D491,105 S * 6/2004 Kim et al. D12/91
D498,437 S * 11/2004 Egger D12/92
D500,708 S * 1/2005 Pfeiffer et al. D12/92

OTHER PUBLICATIONS

Prototype, Toyota LF-S, Motor Magazine, Nov. 15, 2003, pp. 24 & 25.
Honda S2000, Car and Driver Magazine, Jan. 2004, p. 58.

1 Claim, 4 Drawing Sheets

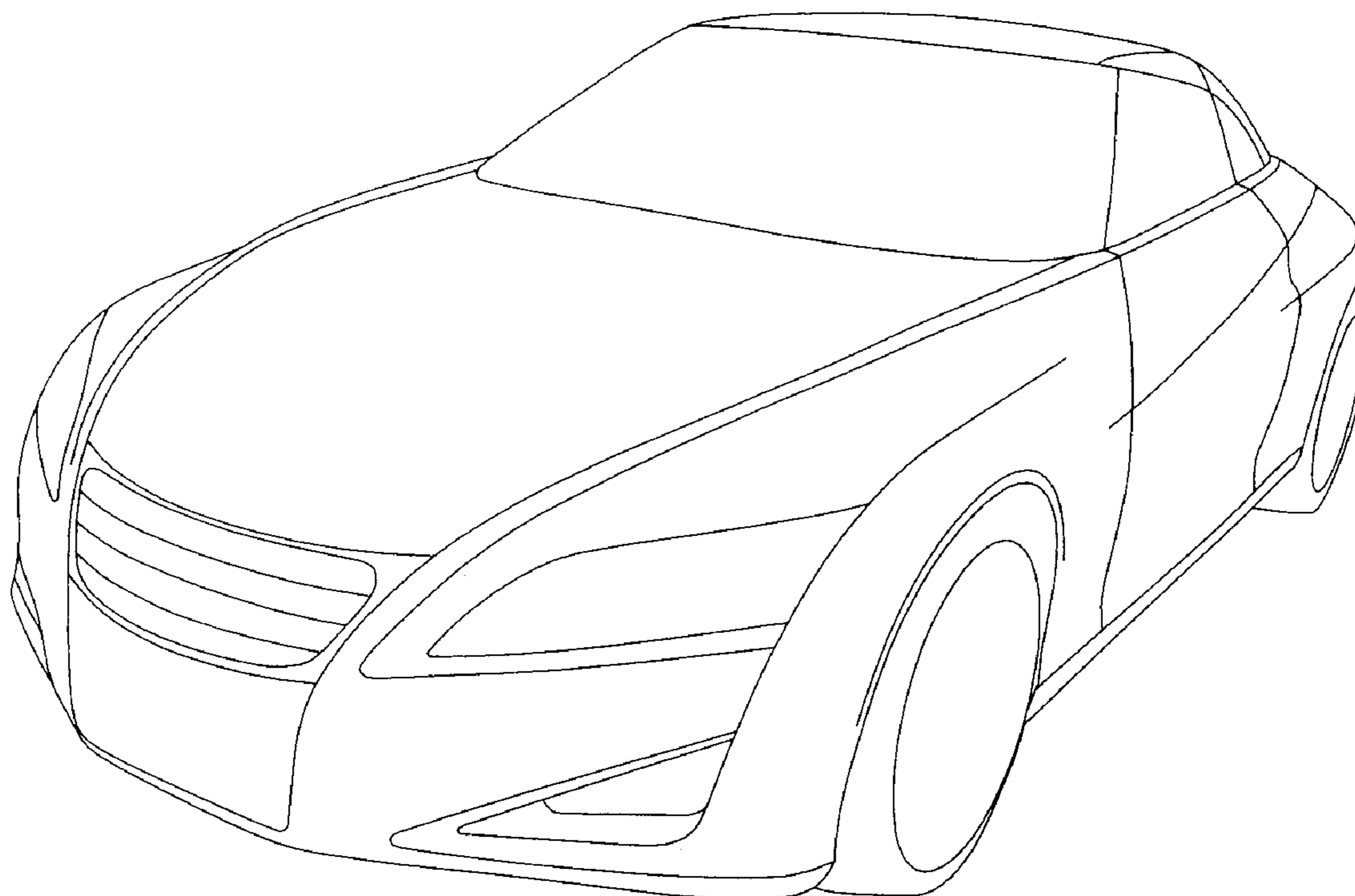

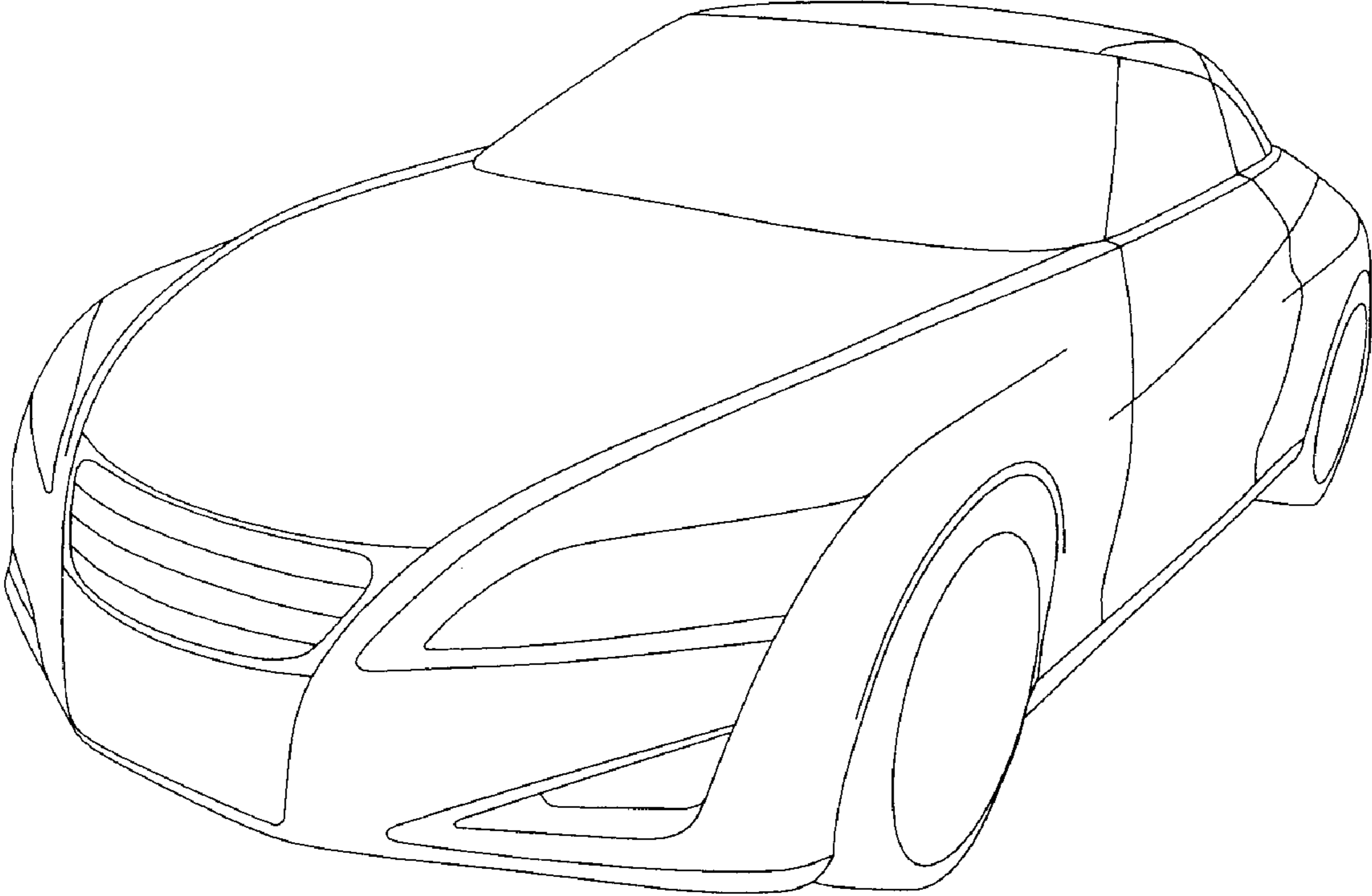

FIG. 1

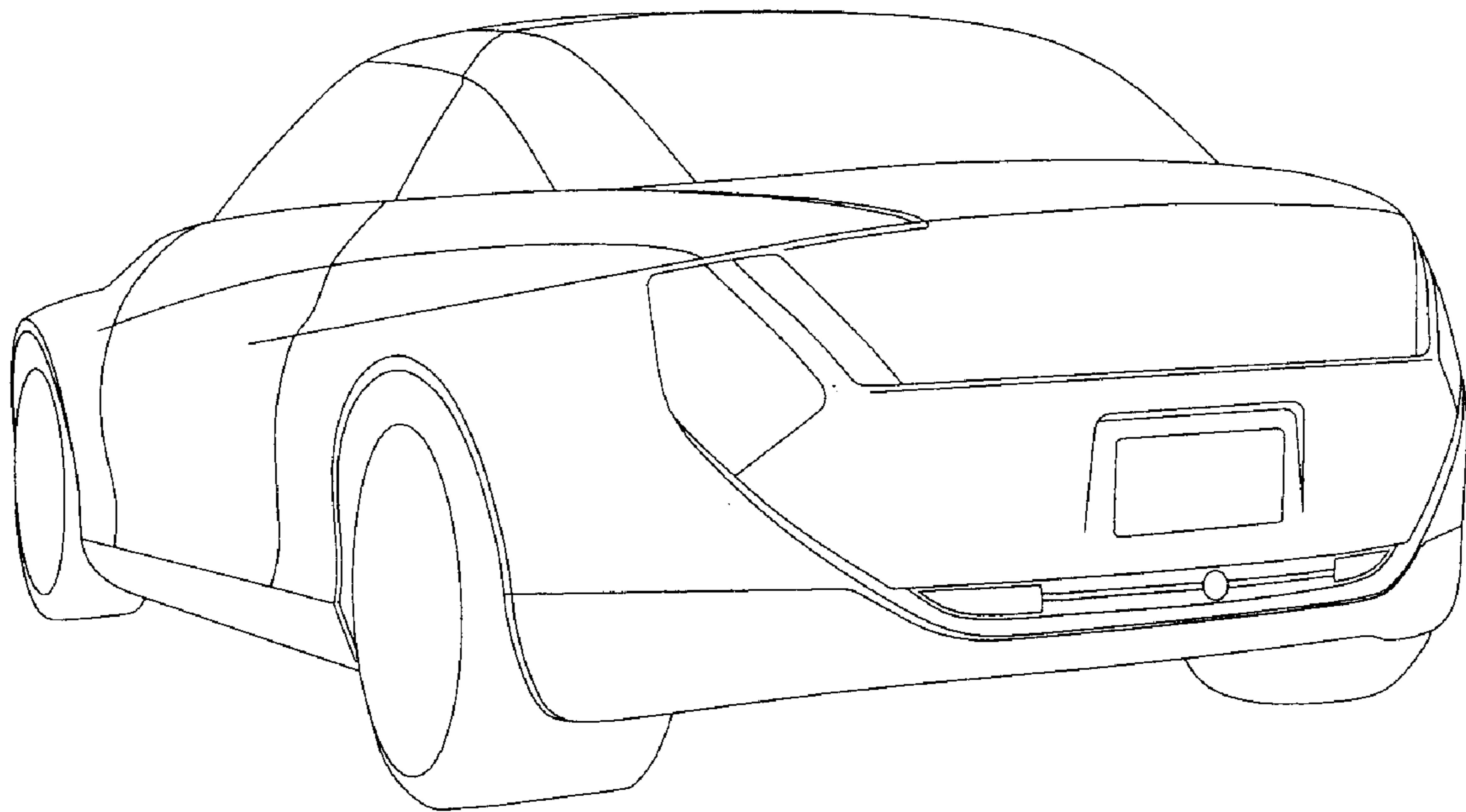

FIG. 2

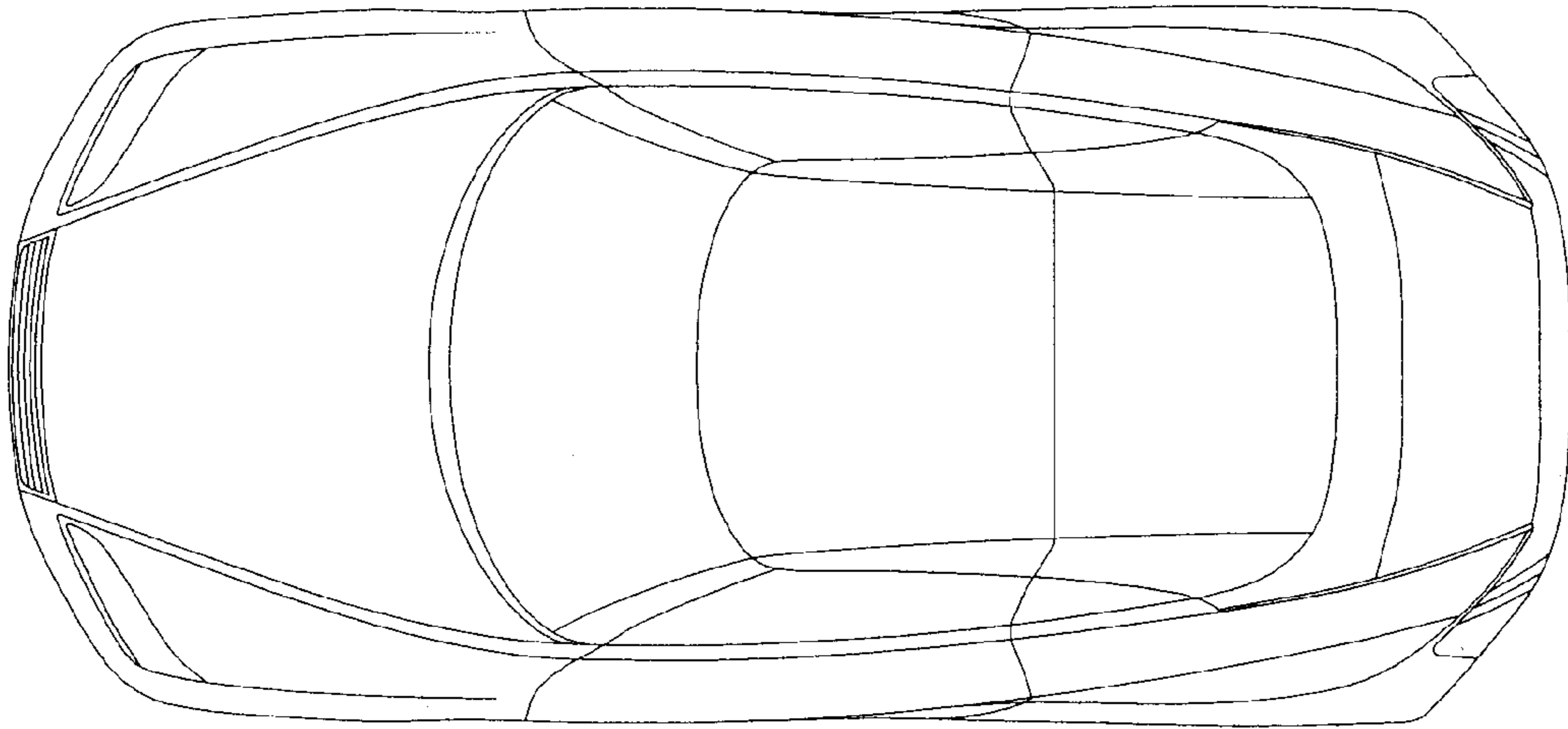

FIG. 4

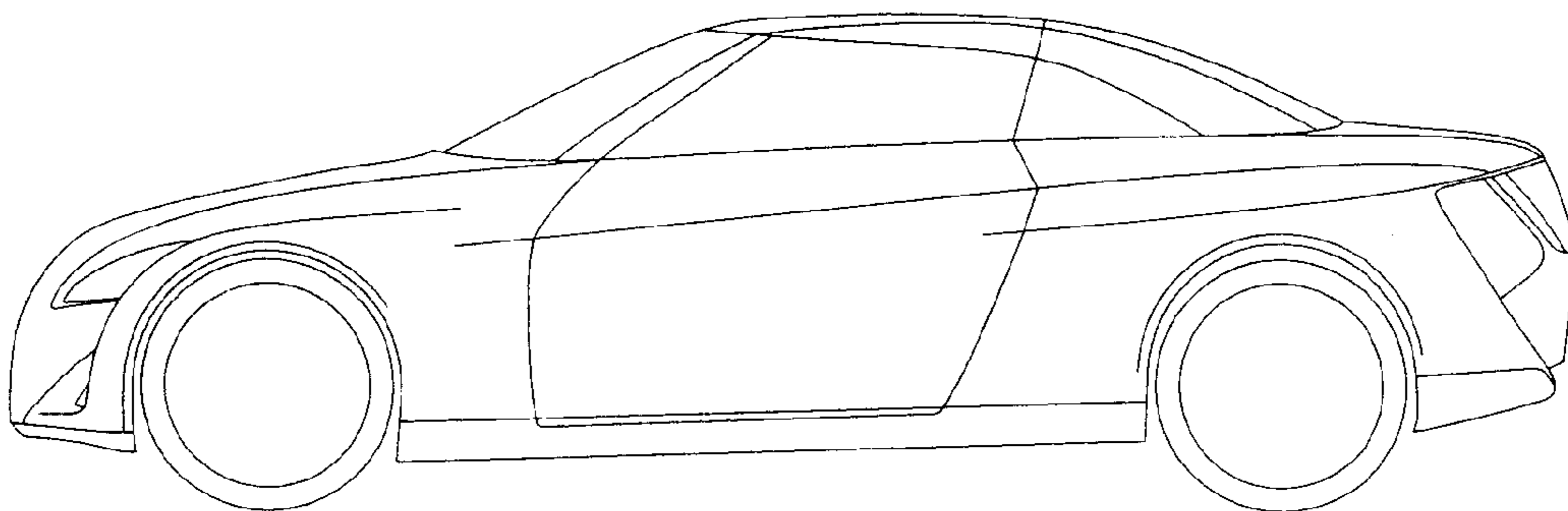

FIG. 3

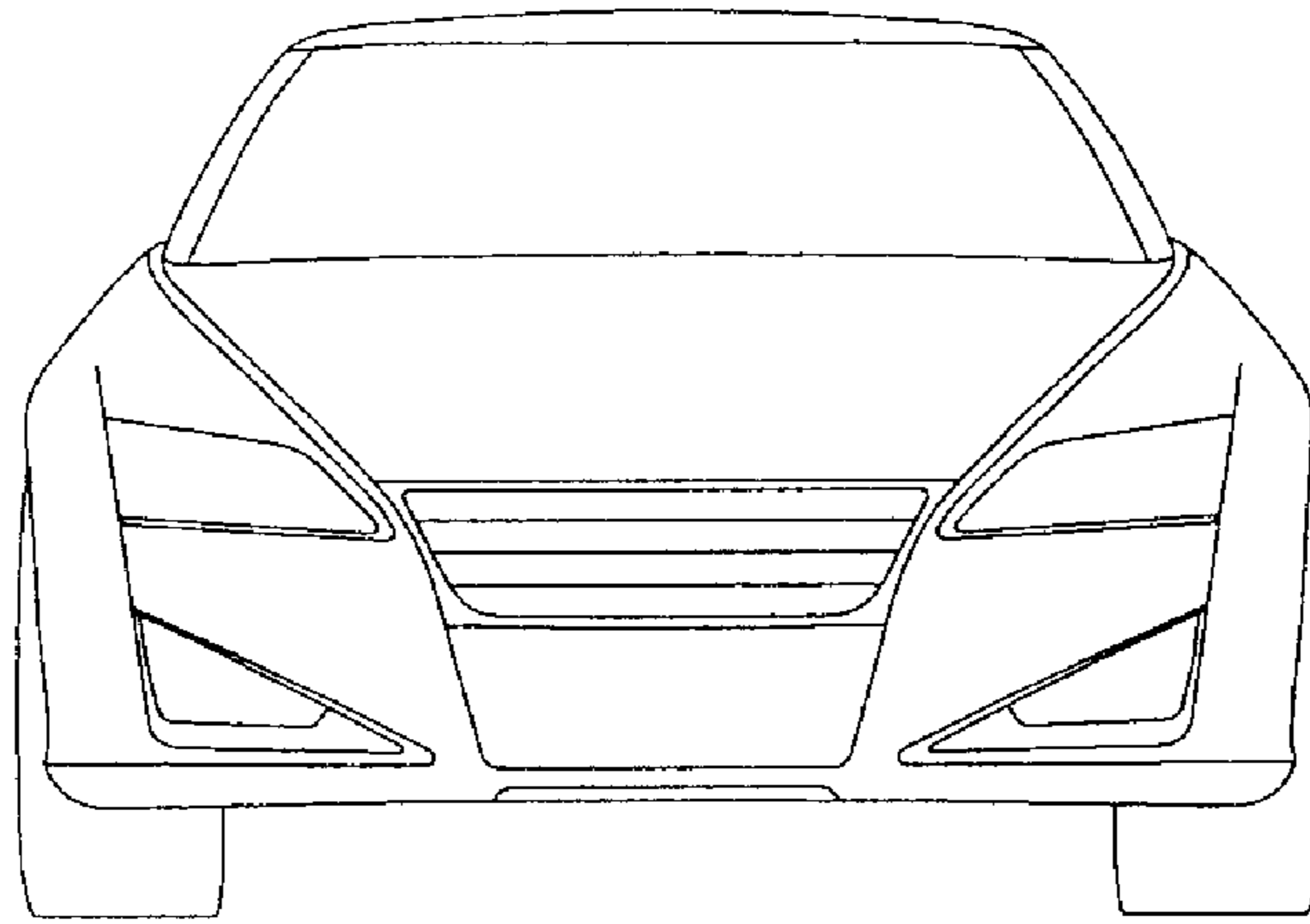

FIG. 5

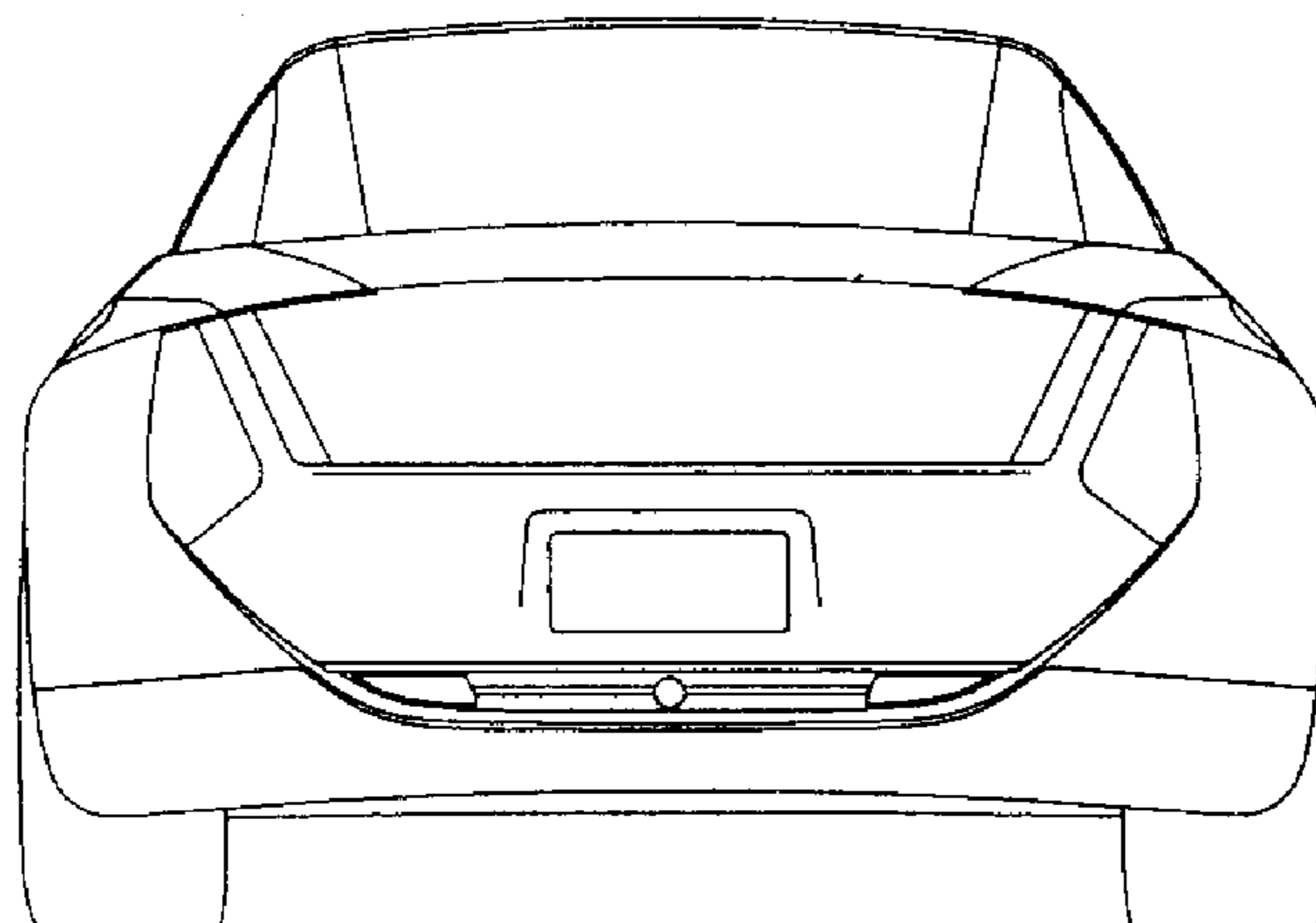

FIG. 6