

US00D508864S

(12) **United States Design Patent**  
**Harris**

(10) **Patent No.:** **US D508,864 S**

(45) **Date of Patent:** **\*\* Aug. 30, 2005**

(54) **DEFENSE TRAFFIC BOLLARD**

(76) **Inventor:** **Paul Meredith Harris, 27 High Street,  
West Malling, Kent (GB), ME19 6QH**

(\*\*) **Term:** **14 Years**

(21) **Appl. No.:** **29/187,306**

(22) **Filed:** **Jul. 31, 2003**

(51) **LOC (8) Cl.** ..... **10-05**

(52) **U.S. Cl.** ..... **D10/109; D10/113**

(58) **Field of Search** ..... D10/104, 106,  
D10/109, 111, 113, 114; 404/6, 9, 10; D25/126;  
D26/68; 256/13.1; 116/63 R, 63 P; 49/35,  
49

(56) **References Cited**

**U.S. PATENT DOCUMENTS**

1,545,711	A	*	7/1925	Townsend	.....	362/305
2,002,756	A	*	5/1935	Segelhorst	.....	116/63 P
D151,629	S	*	11/1948	Lamb et al.	.....	D26/68
2,625,130	A	*	1/1953	Morser	.....	116/63 P
2,646,638	A	*	7/1953	Peterson	.....	116/63 P
3,504,339	A	*	3/1970	Bailey	.....	362/263
3,916,816	A	*	11/1975	Fitch	.....	116/63 P
D258,913	S	*	4/1981	Bressani	.....	D25/109
4,289,419	A	*	9/1981	Young et al.	.....	404/6
D263,454	S	*	3/1982	Leung	.....	D10/109
D279,275	S	*	6/1985	Cory	.....	D10/109
4,557,466	A	*	12/1985	Zucker	.....	256/13.1
4,934,661	A	*	6/1990	Denman et al.	.....	256/13.1
D309,585	S	*	7/1990	Kulp	.....	D10/113
5,026,204	A	*	6/1991	Kulp et al.	.....	404/10
D327,231	S	*	6/1992	Mazzola	.....	D10/113
5,234,280	A	*	8/1993	Cowan	.....	404/6

D362,200	S	*	9/1995	Harris	.....	D10/113
5,722,788	A	*	3/1998	Bent et al.	.....	404/6
D396,552	S	*	8/1998	Browne	.....	D3/211
5,927,896	A	*	7/1999	Gertz	.....	404/6
6,019,542	A	*	2/2000	Bent et al.	.....	404/6
6,071,037	A	*	6/2000	Holt	.....	404/6
D440,172	S	*	4/2001	Cuttill et al.	.....	D10/113
6,536,369	B1	*	3/2003	Bent et al.	.....	116/63 P
D481,965	S	*	11/2003	Feit et al.	.....	D10/113
D482,631	S	*	11/2003	Brown	.....	D10/109
D486,089	S	*	2/2004	Mettler et al.	.....	D10/109

\* cited by examiner

*Primary Examiner*—Jeffrey Asch

(57) **CLAIM**

The ornamental design for a defense traffic bollard, as shown and described.

**DESCRIPTION**

FIG. 1 is a sectionalised front view of the preferred embodiment of the present design cut away to show detail of construction.

FIG. 2 is a side view of the article.

FIG. 3 is a plan view.

FIG. 4 is a view from the underside.

FIG. 5 is a three dimensional representation of the preferred embodiment of the present design

FIG. 6 is a side elevation of a further embodiment of the design in the same general shape of a bell of the same base diameter and similarly sloping sides but with a modified crown.

FIG. 7 is a side elevation taken from the right of FIG. 6; and, FIG. 8 is a plan view.

**1 Claim, 3 Drawing Sheets**

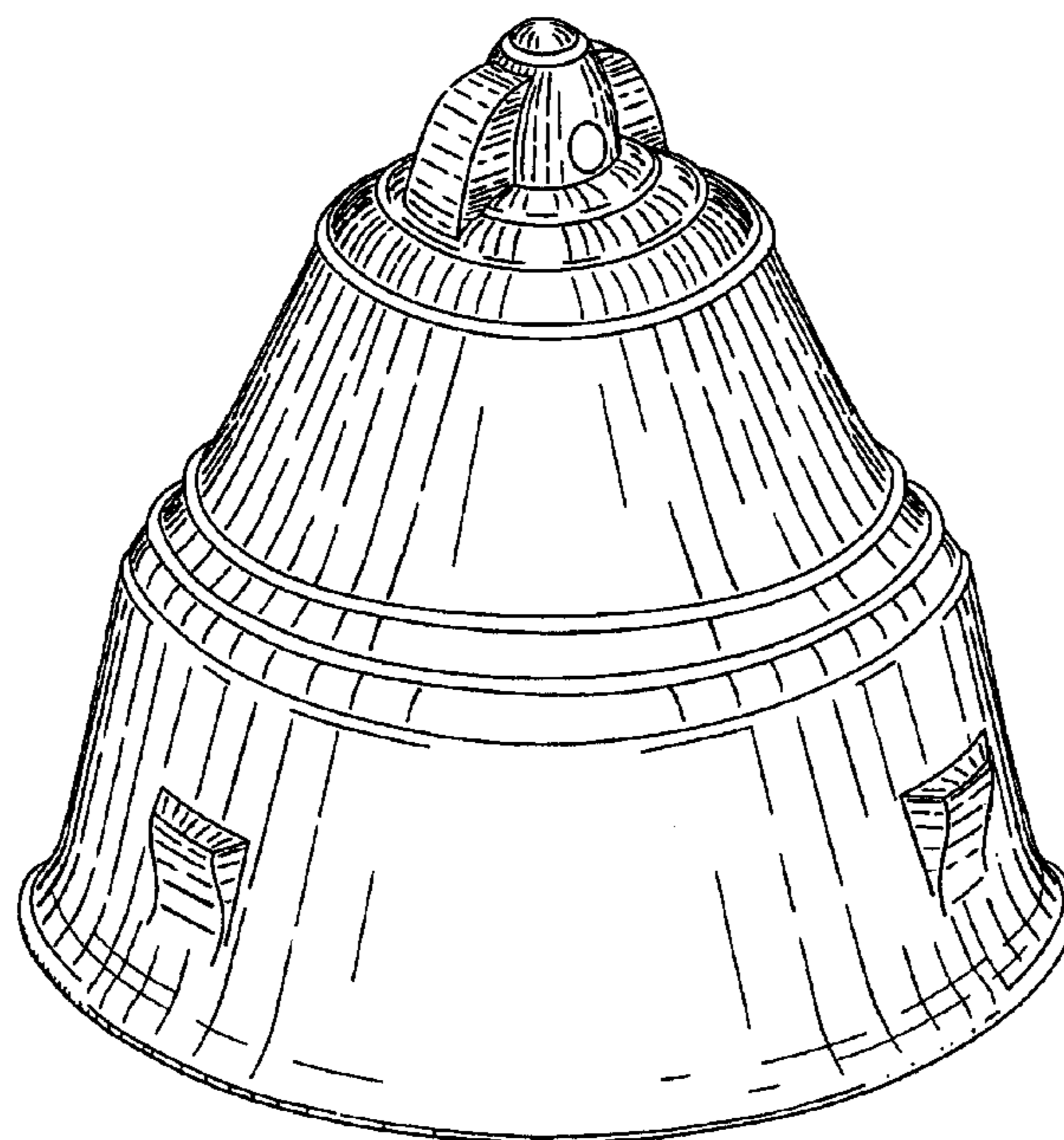

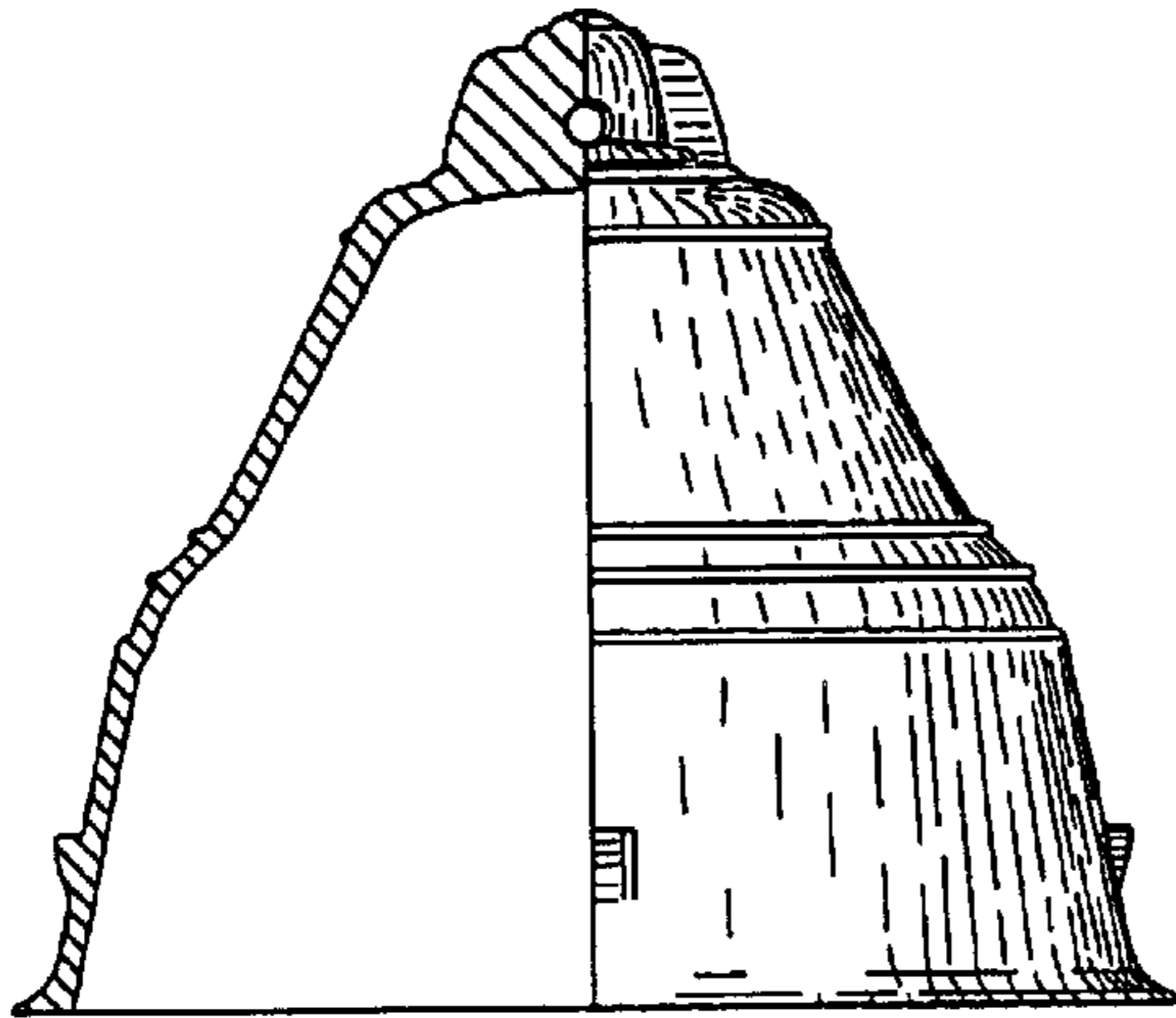

FIG 1.

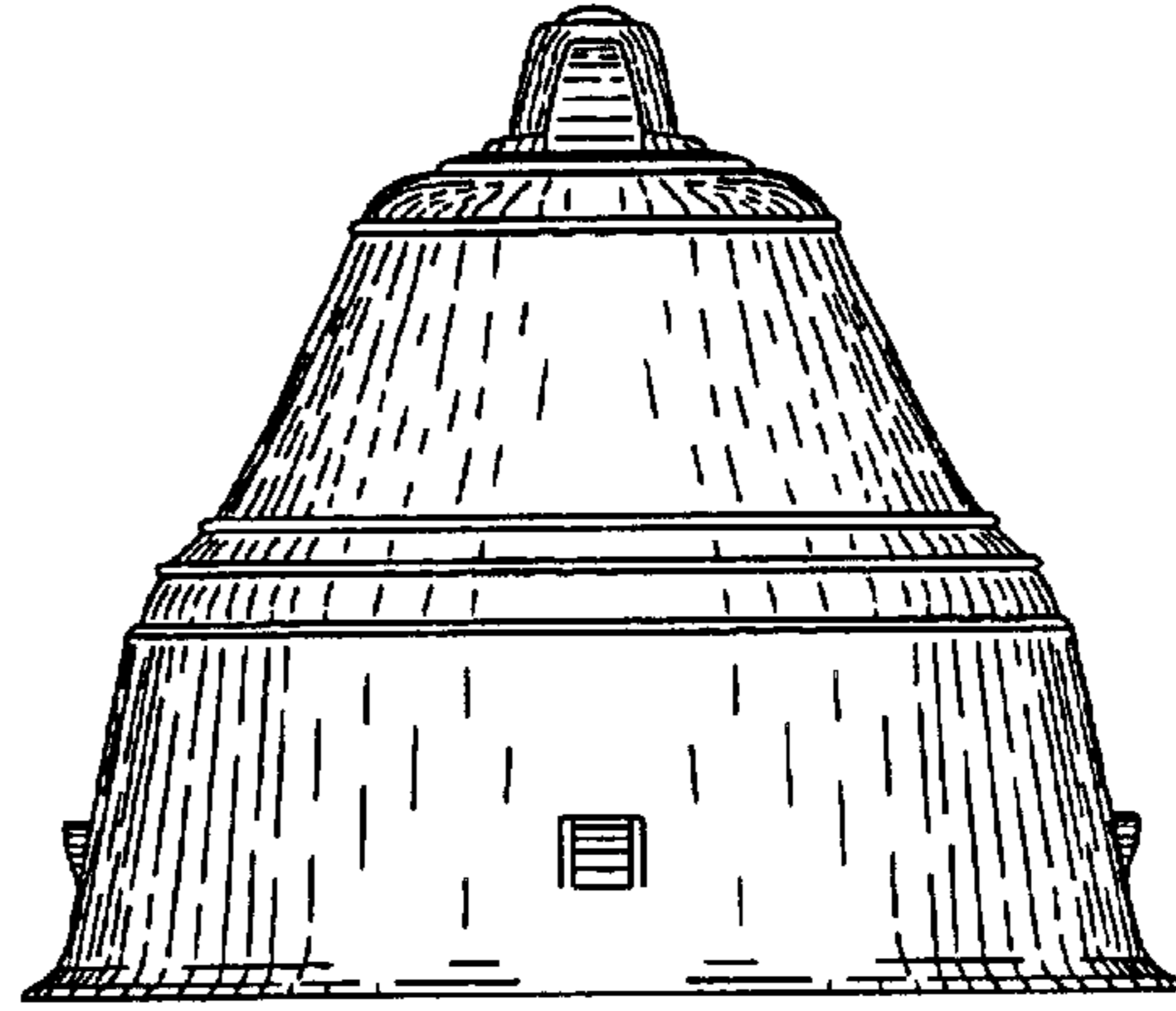

FIG 2.

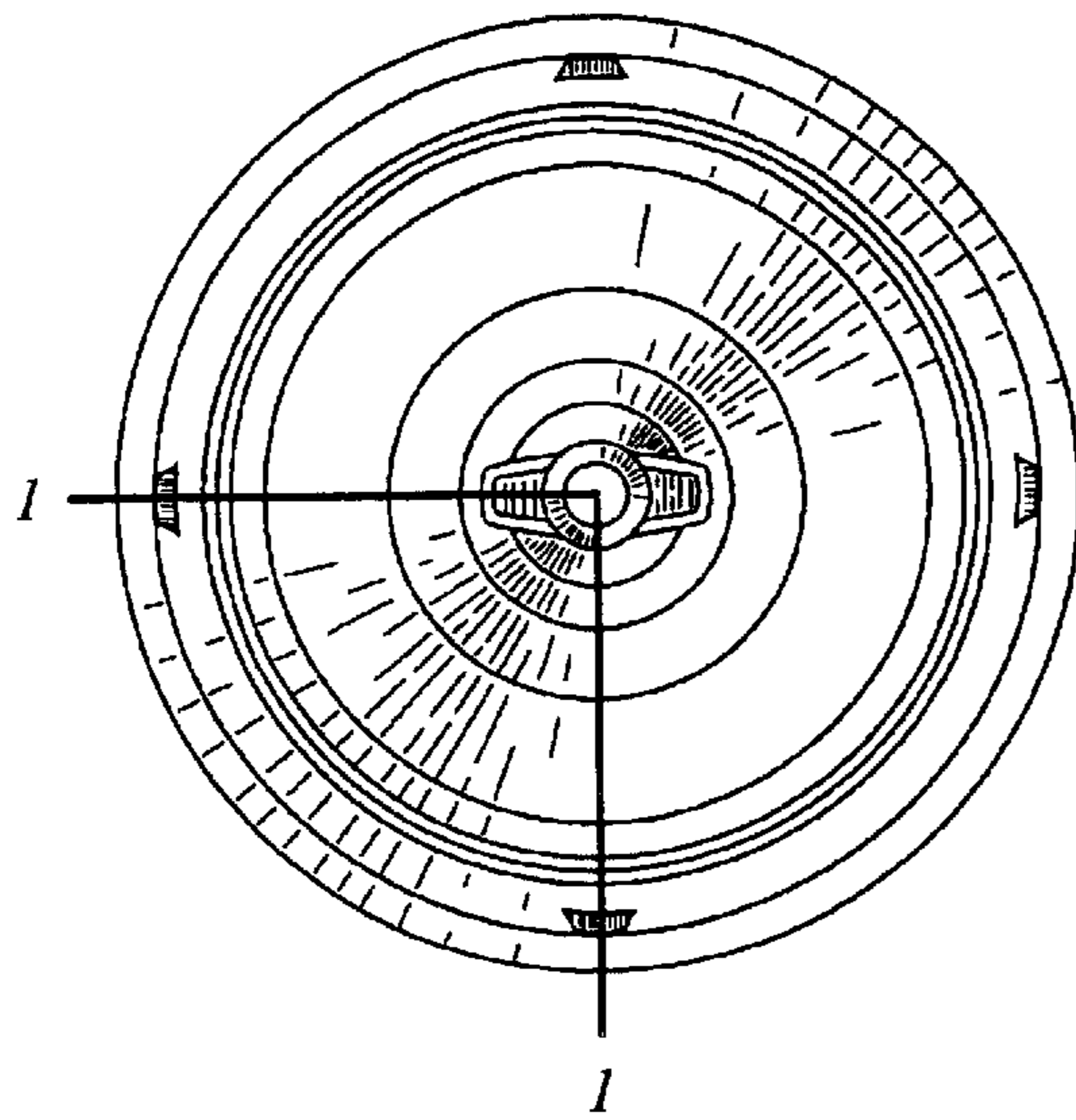

FIG 3.

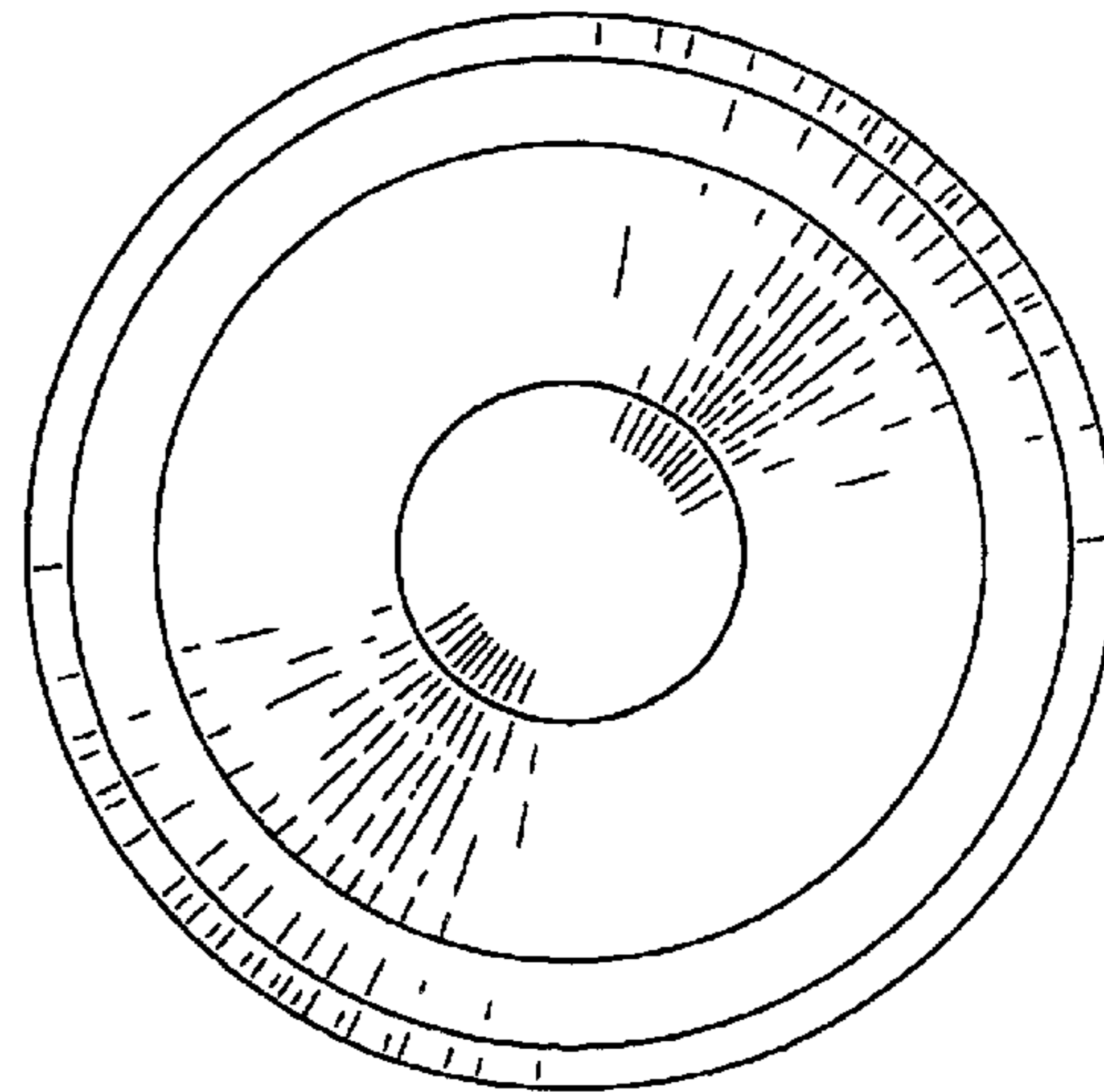

FIG 4.

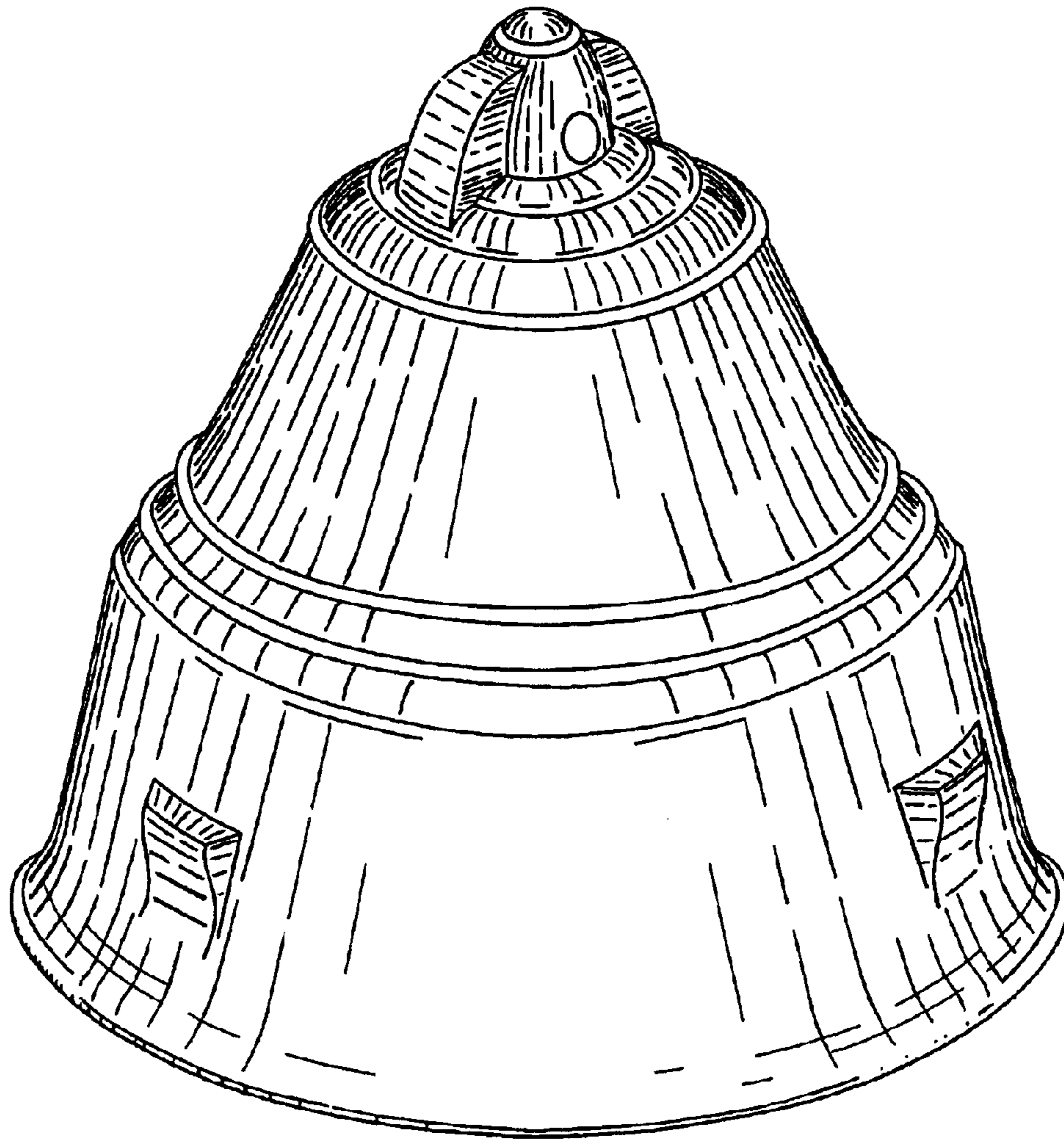

FIG 5.



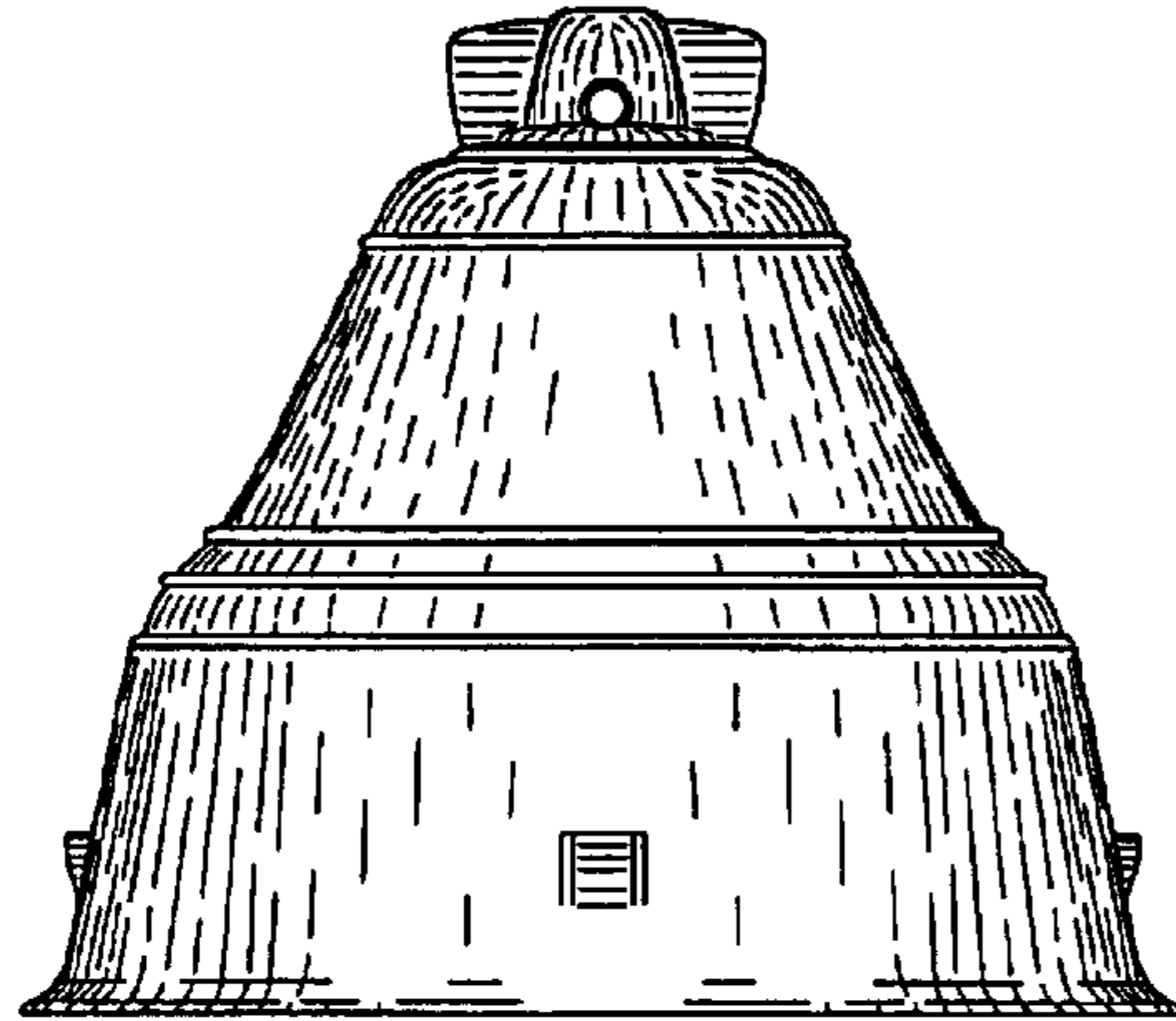

FIG 6.

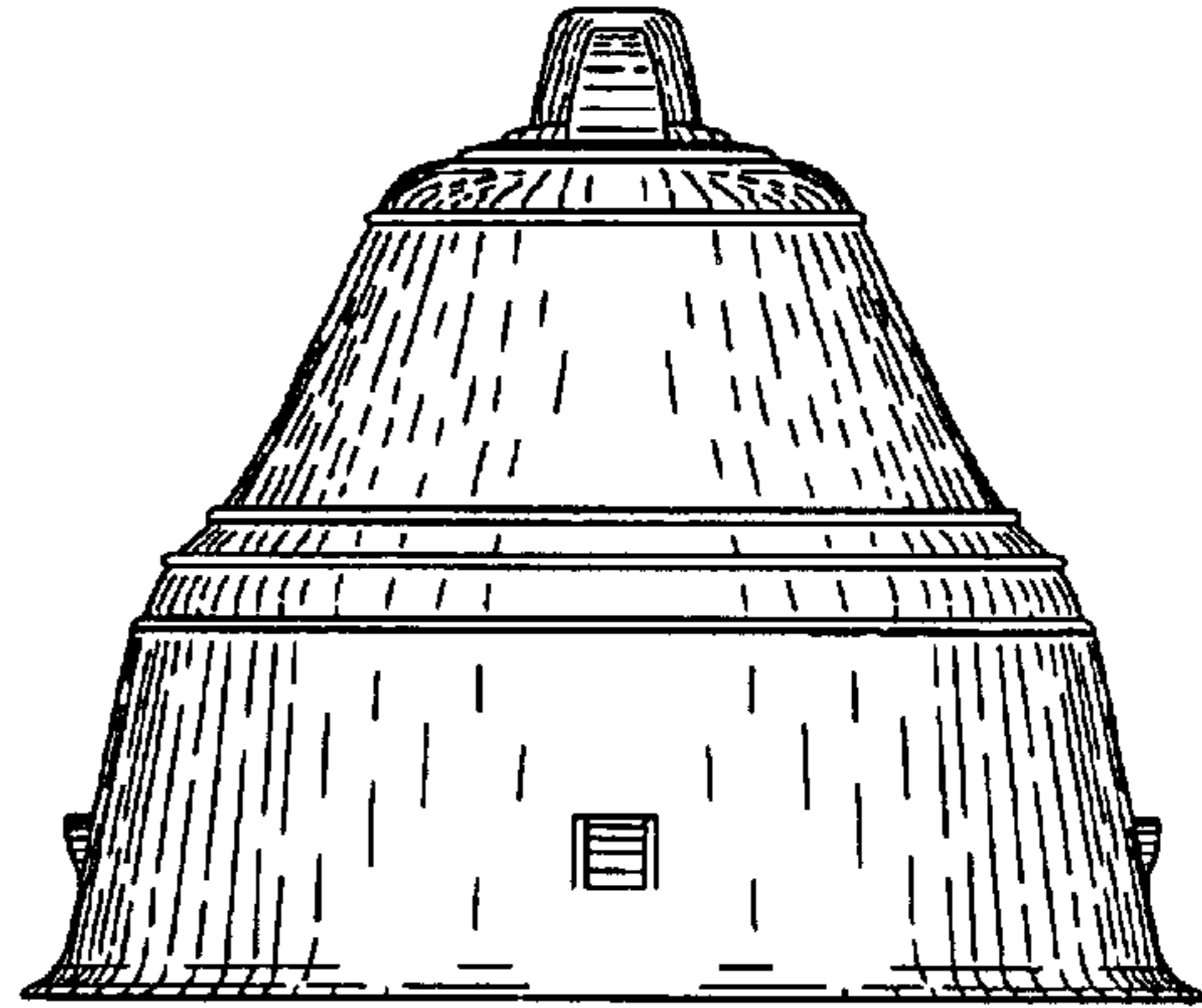

FIG 7.

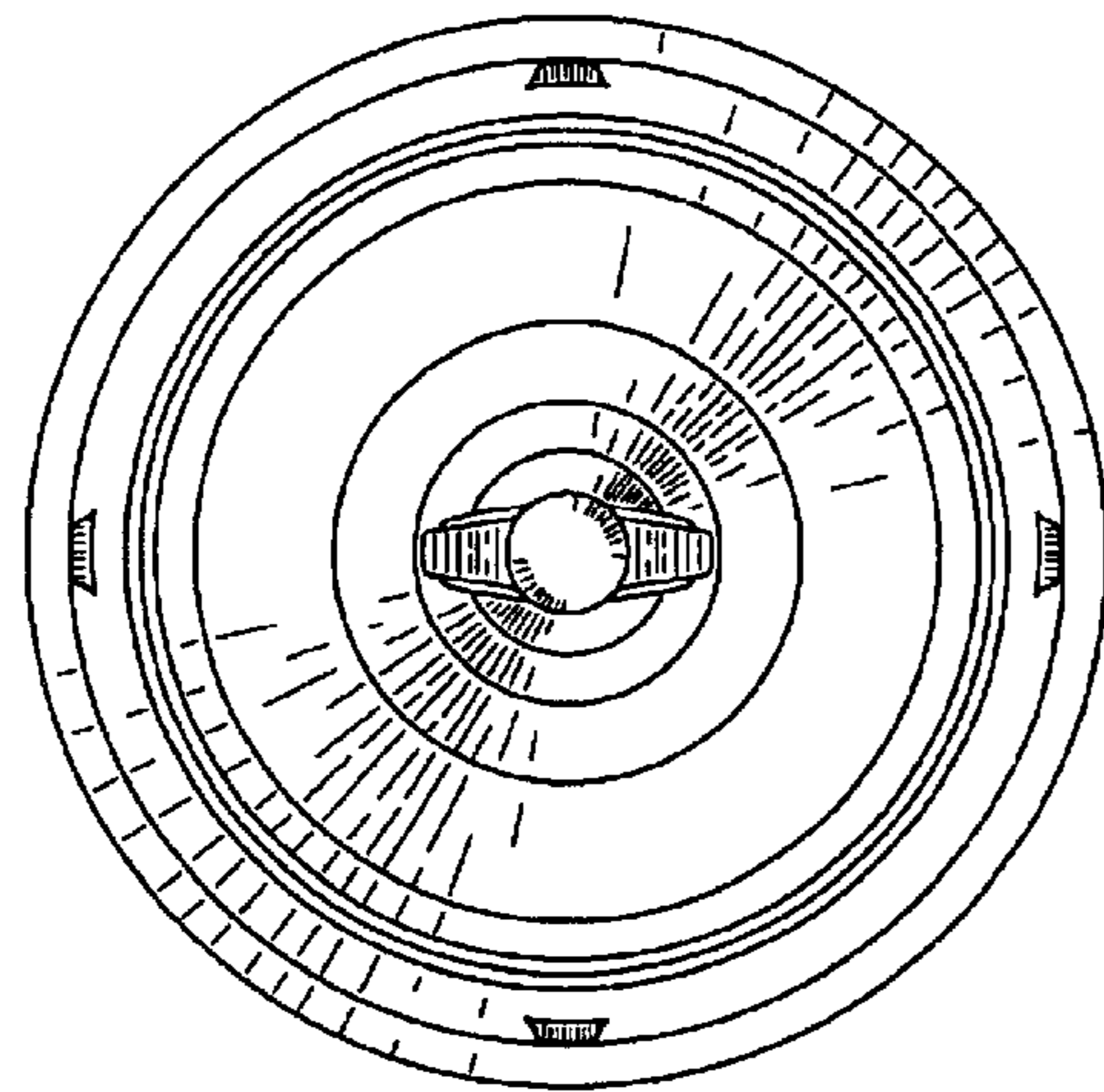

FIG 8.