

US00D508820S

(12) **United States Design Patent** (10) **Patent No.:** **US D508,820 S**
Wong (45) **Date of Patent:** **** Aug. 30, 2005**

(54) **SPATULA HANDLE**

(76) Inventor: **Vincent Wong**, 13203-B NE. 16th, Bellevue, WA (US) 98005

(**) Term: **14 Years**

(21) Appl. No.: **29/206,016**

(22) Filed: **May 24, 2004**

(51) **LOC (8) Cl.** **07-04**

(52) **U.S. Cl.** **D7/393; D7/395**

(58) **Field of Search** D7/393, 395, 401.2, D7/354-361; D4/138; D8/1, 107; 16/110.1, 430, 431, 436, 441, 444; 220/759, 757, 769, 770

(56) **References Cited**

U.S. PATENT DOCUMENTS

D399,388 S	*	10/1998	Cohen et al.	D7/393
D422,451 S	*	4/2000	Ancona et al.	D7/395
D427,030 S	*	6/2000	Wen	D8/1
D487,554 S	*	3/2004	Smekh	D7/395
D497,771 S	*	11/2004	Thomkins	D7/395
D498,117 S	*	11/2004	Lorthoir	D7/395
D500,925 S	*	1/2005	Hay et al.	D4/138
D500,927 S	*	1/2005	Hay	D8/107

* cited by examiner

Primary Examiner—Ruth McInroy

Assistant Examiner—Terrence Huang

(74) *Attorney, Agent, or Firm*—Matthew W. Jellett; Hughes Law Firm, PLLC

(57) **CLAIM**

The ornamental design for spatula handle, as shown and described.

DESCRIPTION

FIG. 1 is a top perspective view of a spatula handle showing my new design;

FIG. 2 is a bottom perspective view thereof;

FIG. 3 is an enlarged bottom plan view thereof, the spatula lower portion not shown for ease of illustration;

FIG. 4 is an enlarged top plan view thereof, the spatula lower portion not shown for ease of illustration;

FIG. 5 is an enlarged top perspective view thereof, the spatula lower portion not shown for ease of illustration; and,

FIG. 6 is an enlarged bottom perspective view thereof, the spatula lower portion not shown for ease of illustration.

The broken lines are environmental and are not part of the claimed design.

1 Claim, 3 Drawing Sheets

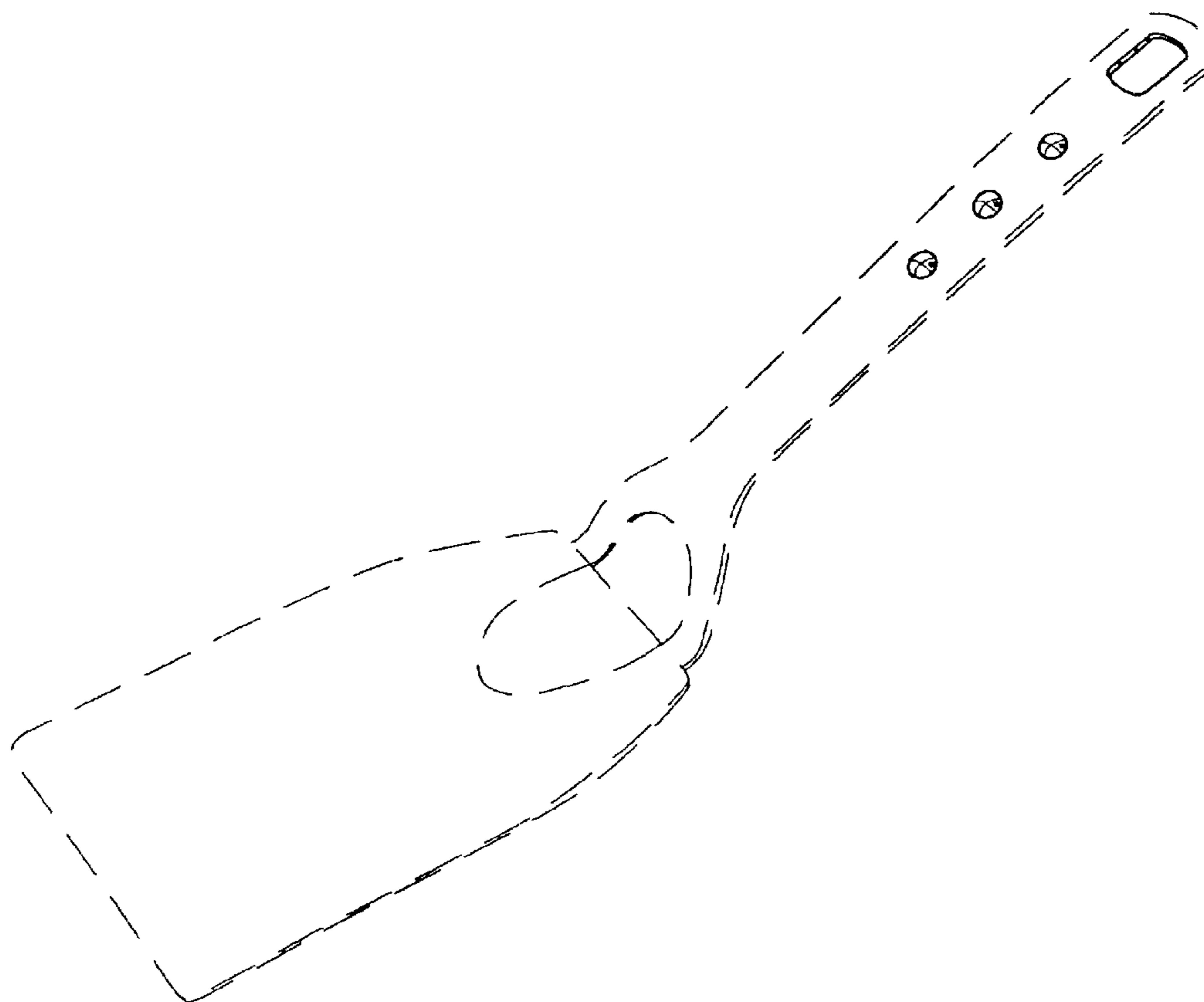

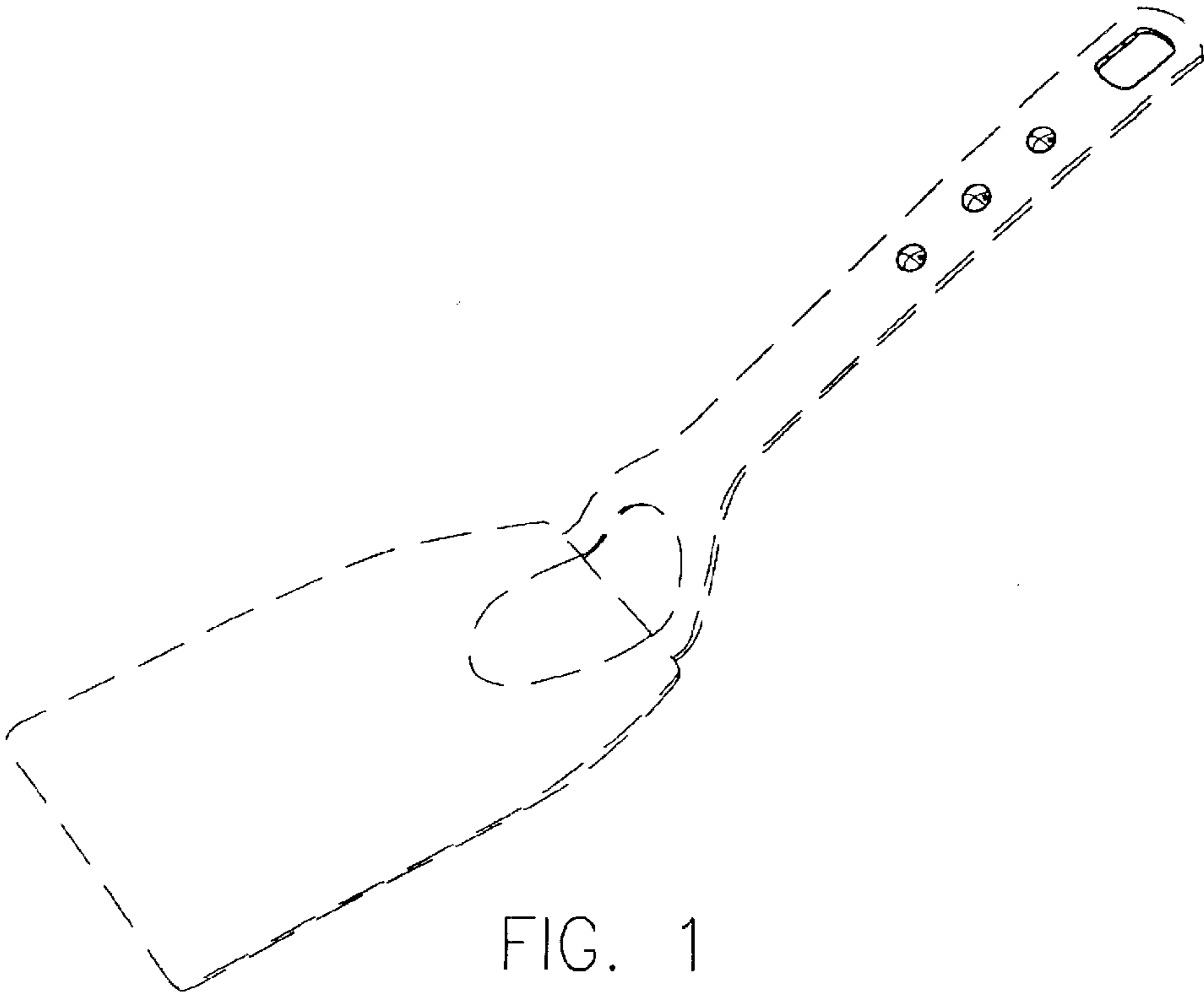

FIG. 1

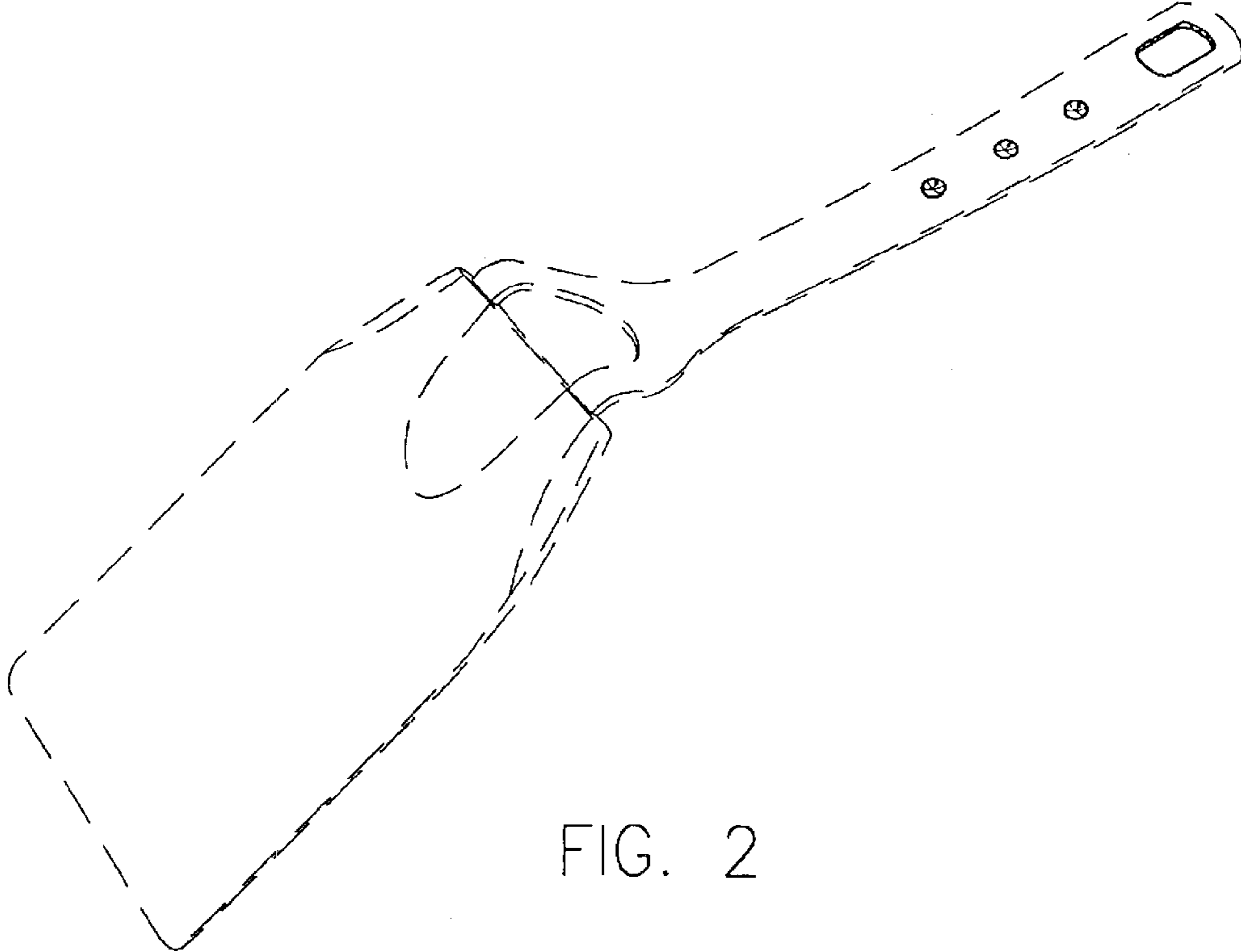

FIG. 2

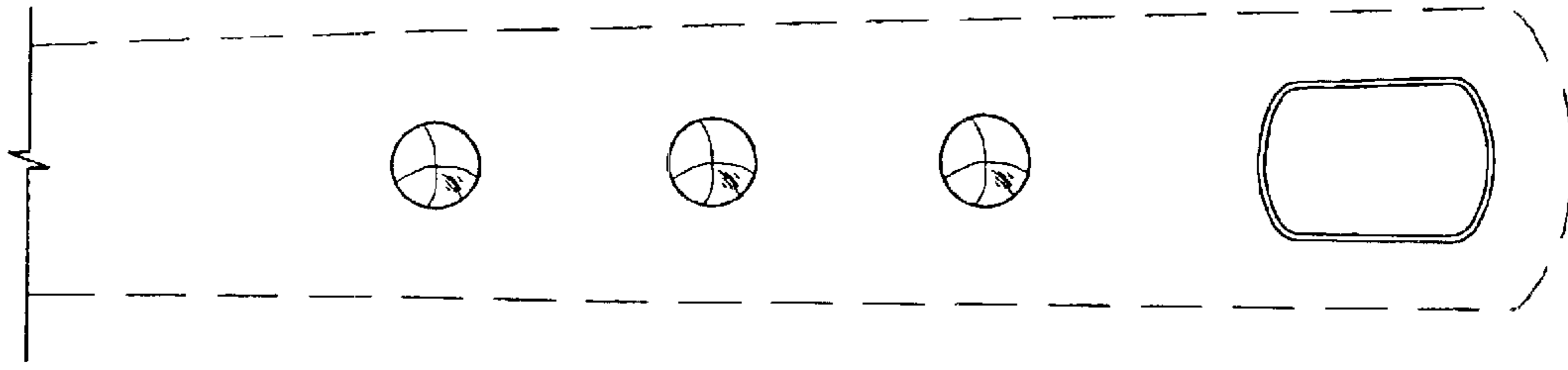

FIG. 3

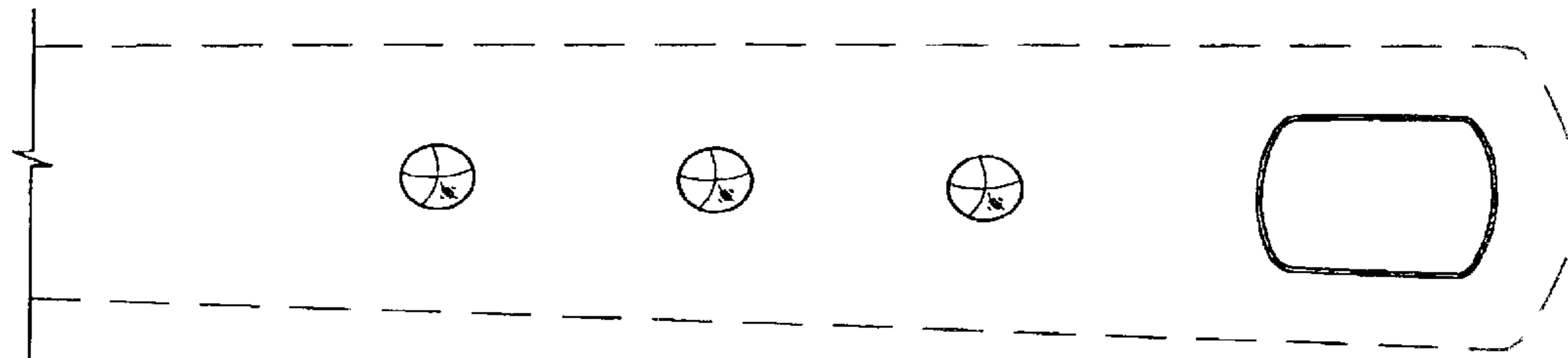

FIG. 4

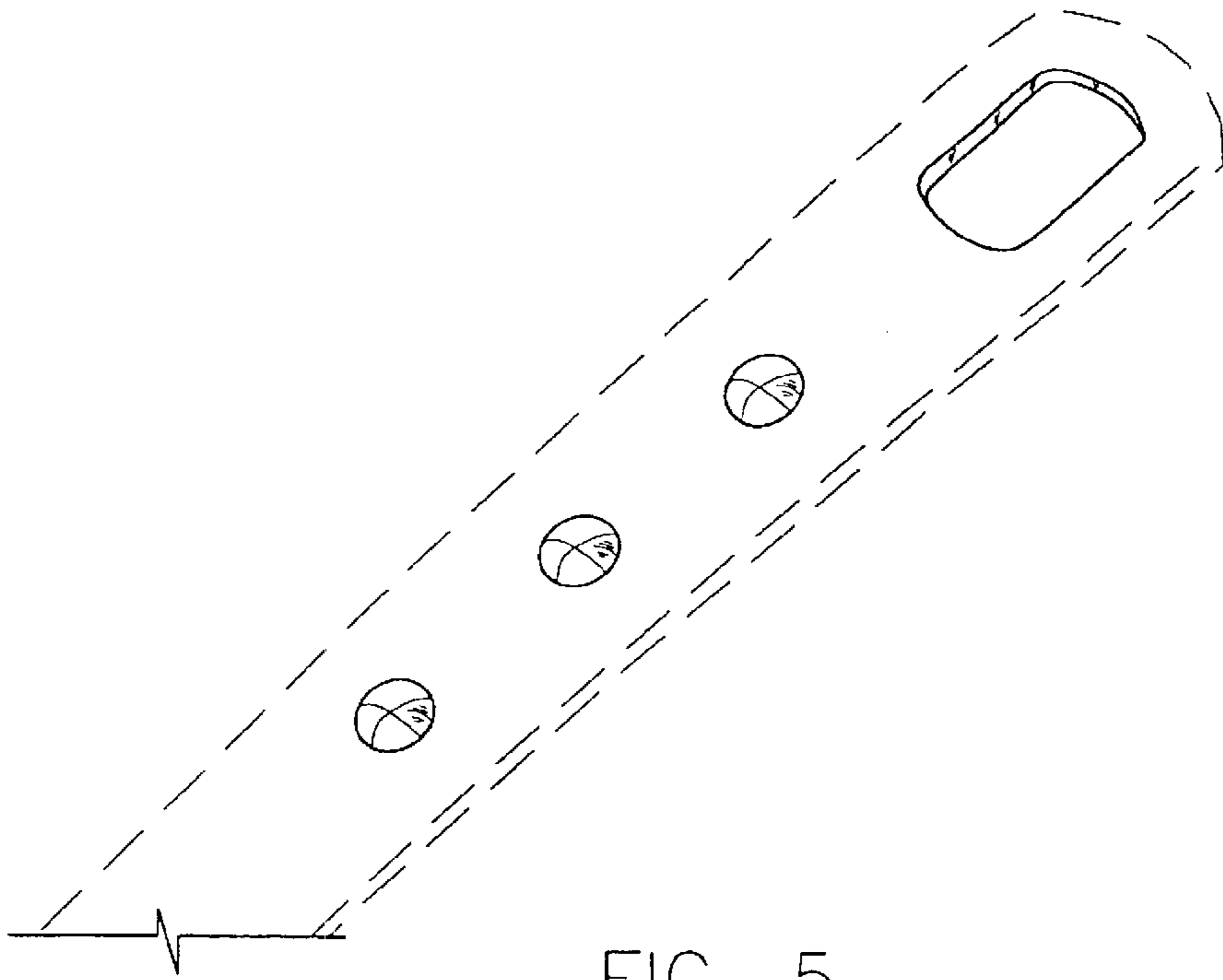

FIG. 5

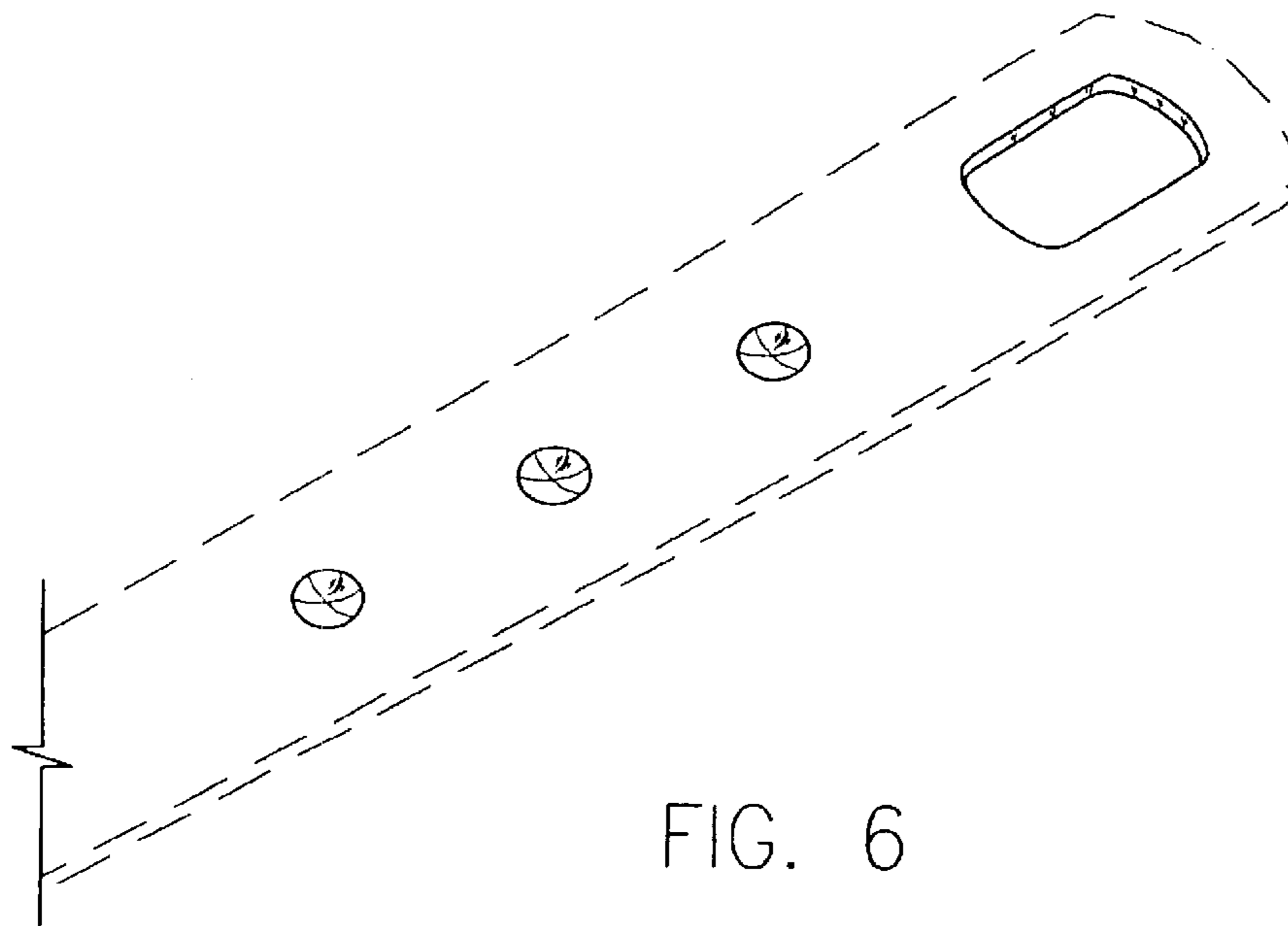

FIG. 6