

US00D508761S

(12) **United States Design Patent**
Haro

(10) **Patent No.: US D508,761 S**

(45) **Date of Patent: ** Aug. 30, 2005**

(54) **WAND-SHAPED FOOD PRODUCT**

(75) **Inventor: Guillermo Haro, Skokie, IL (US)**

(73) **Assignee: Kraft Foods Holdings, Inc., Northfield, IL (US)**

(**) **Term: 14 Years**

(21) **Appl. No.: 29/207,530**

(22) **Filed: Jun. 15, 2004**

Related U.S. Application Data

(62) **Division of application No. 29/189,067, filed on Aug. 28, 2003, now Pat. No. Des. 495,462.**

(51) **LOC (8) Cl. 01-01**

(52) **U.S. Cl. D1/106; D1/126**

(58) **Field of Search D1/106, 126, 115; D21/402; D11/70, 48; 426/106**

(56) **References Cited**

U.S. PATENT DOCUMENTS

D136,581 S	*	11/1943	Hagopian	D21/402
D317,183 S		5/1991	Neuroth et al.		
D324,753 S		3/1992	Meyers, Jr. et al.		
D325,804 S		5/1992	Meyers, Jr. et al.		
D326,553 S		6/1992	Meyers, Jr. et al.		
D352,811 S		11/1994	Gonzalez		

D374,573 S		10/1996	Brunner et al.		
D380,886 S		7/1997	Hauser et al.		
D381,185 S		7/1997	Hauser et al.		
D381,486 S		7/1997	Hauser et al.		
D392,435 S		3/1998	Mocking et al.		
D392,785 S	*	3/1998	Villota et al.	D1/115
D394,535 S		5/1998	Villota et al.		
D417,332 S		12/1999	Dawe et al.		
D437,101 S		2/2001	Debbouz et al.		

* cited by examiner

Primary Examiner—Pamela Burgess

(74) *Attorney, Agent, or Firm*—Fitch, Even, Tabin & Flannery

(57) **CLAIM**

The ornamental design for a wand-shaped food product, as shown and described.

DESCRIPTION

FIG. 1 is a top perspective view of a wand-shaped food product showing my new design;
 FIG. 2 is a front elevational view thereof, the rear elevational view being identical;
 FIG. 3 is a left side elevational view thereof;
 FIG. 4 is a right side elevational view thereof;
 FIG. 5 is a bottom plan view thereof; and,
 FIG. 6 is a top plan view thereof.

1 Claim, 1 Drawing Sheet

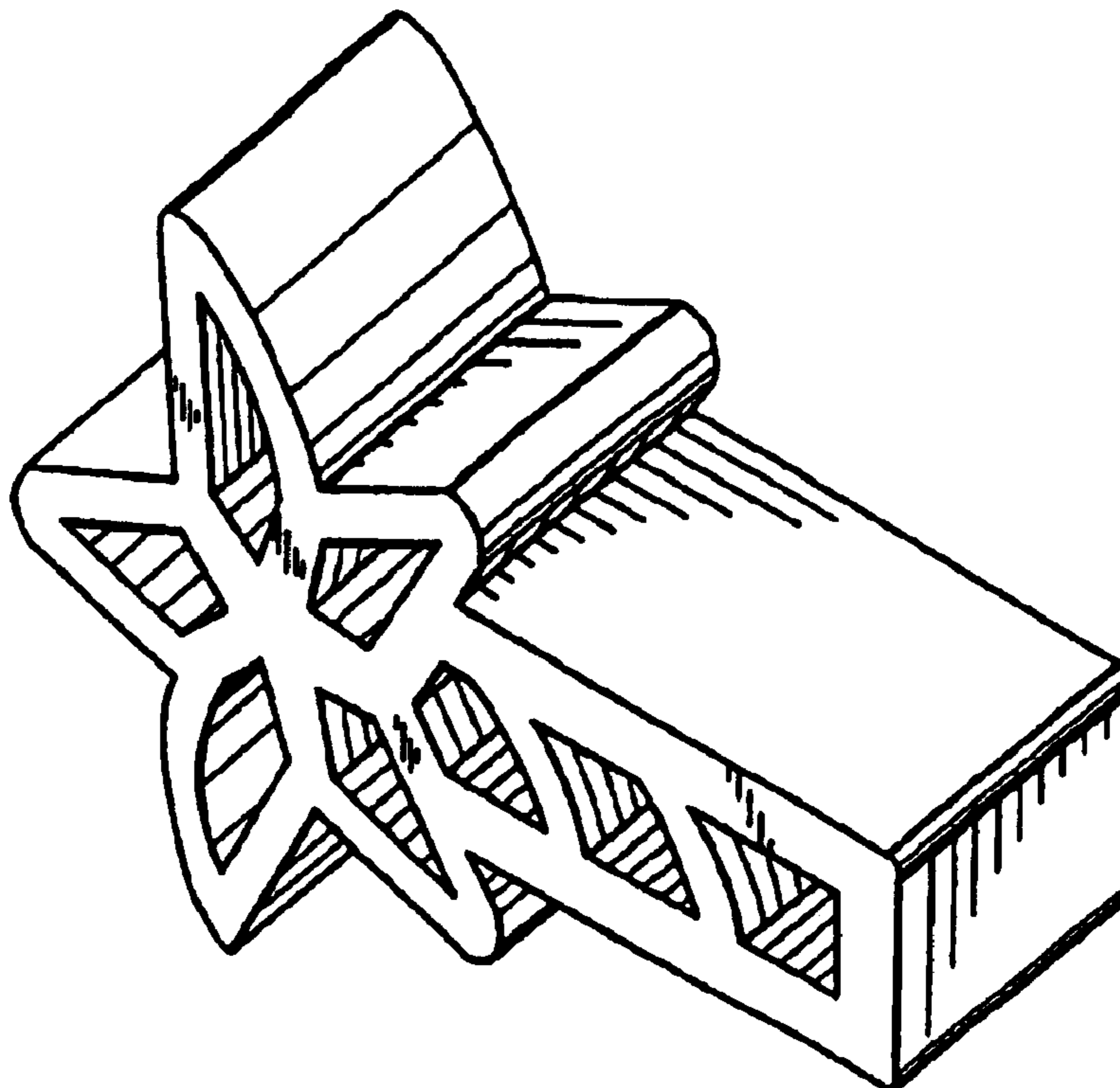

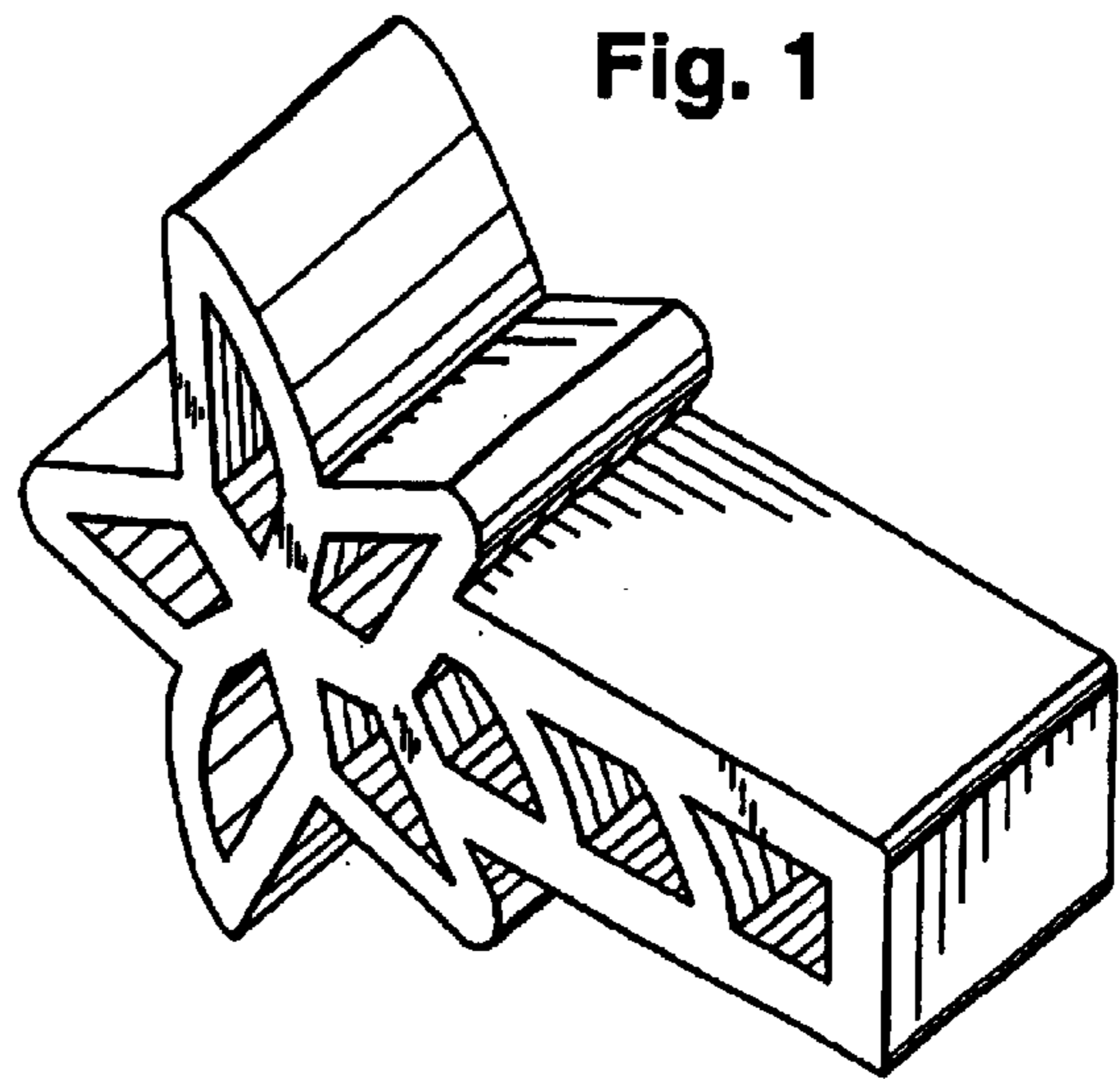

Fig. 1

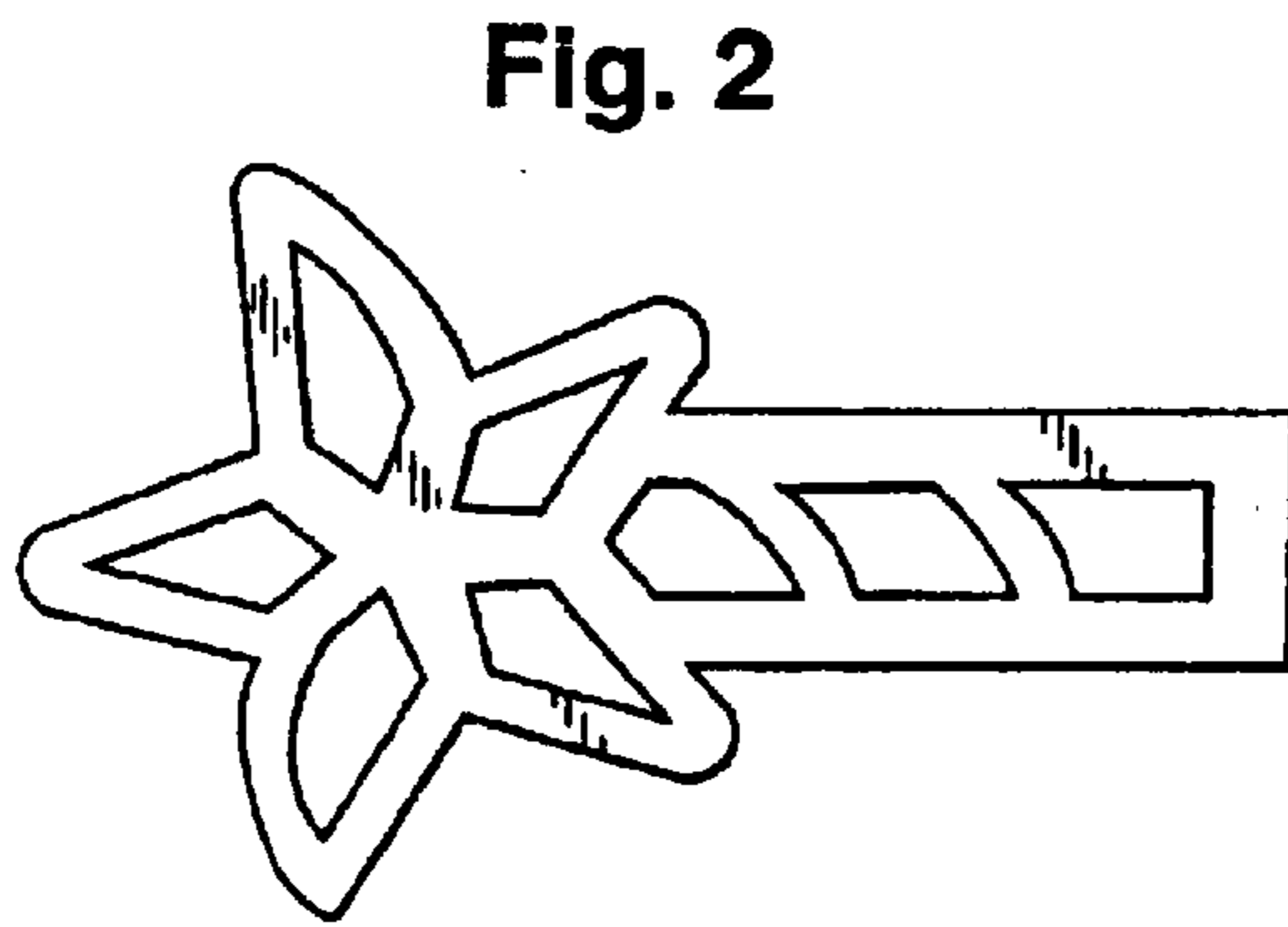

Fig. 2

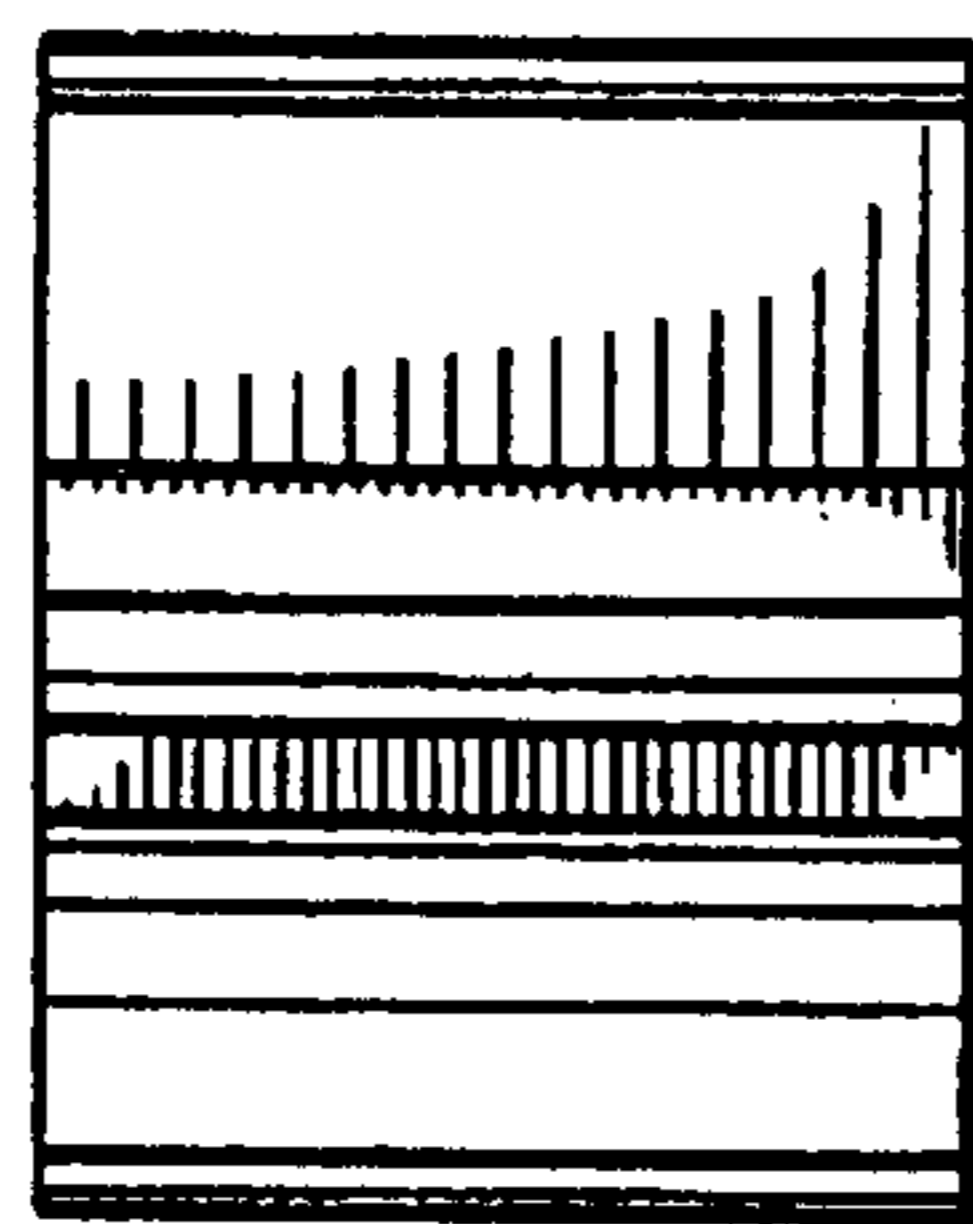

Fig. 3

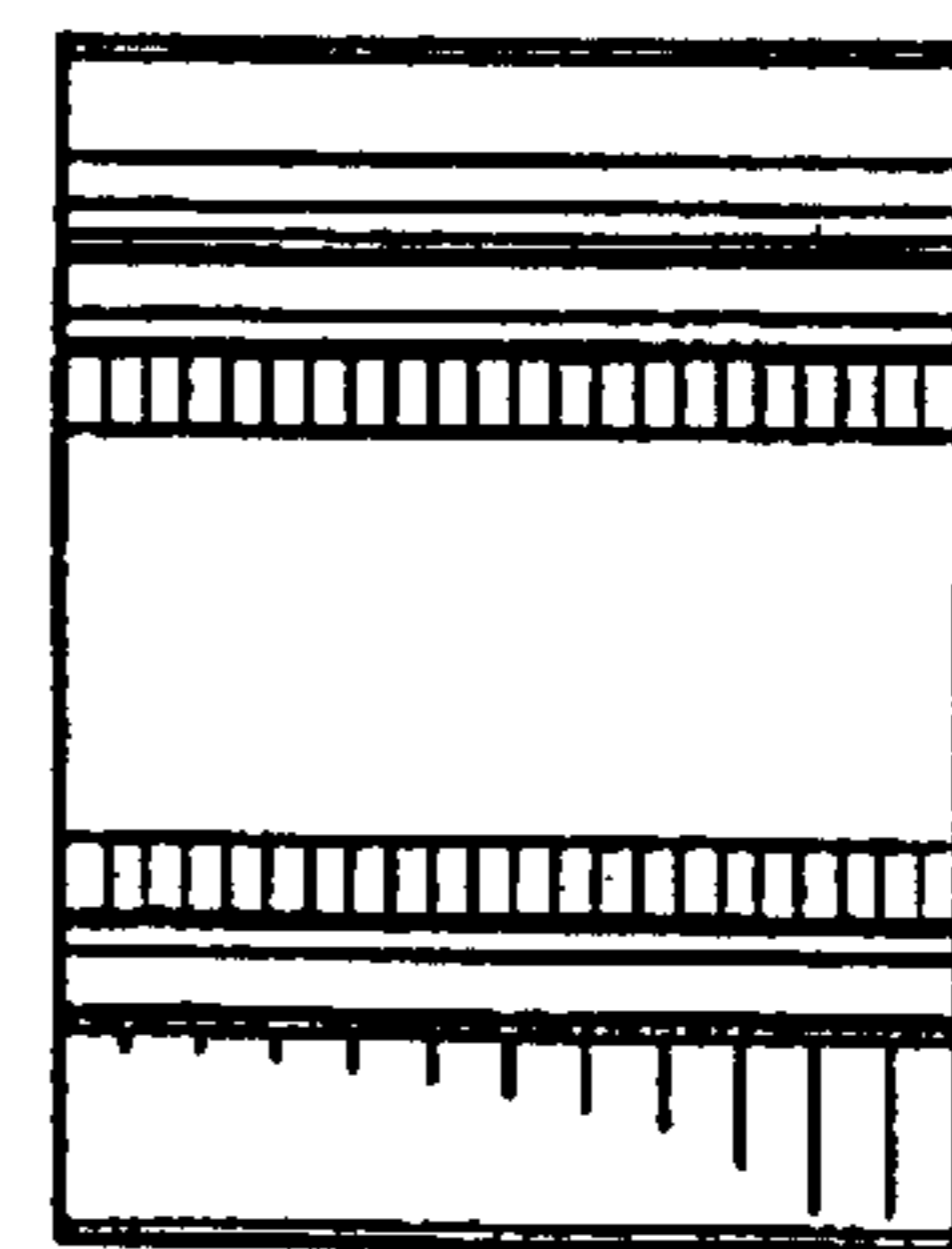

Fig. 4

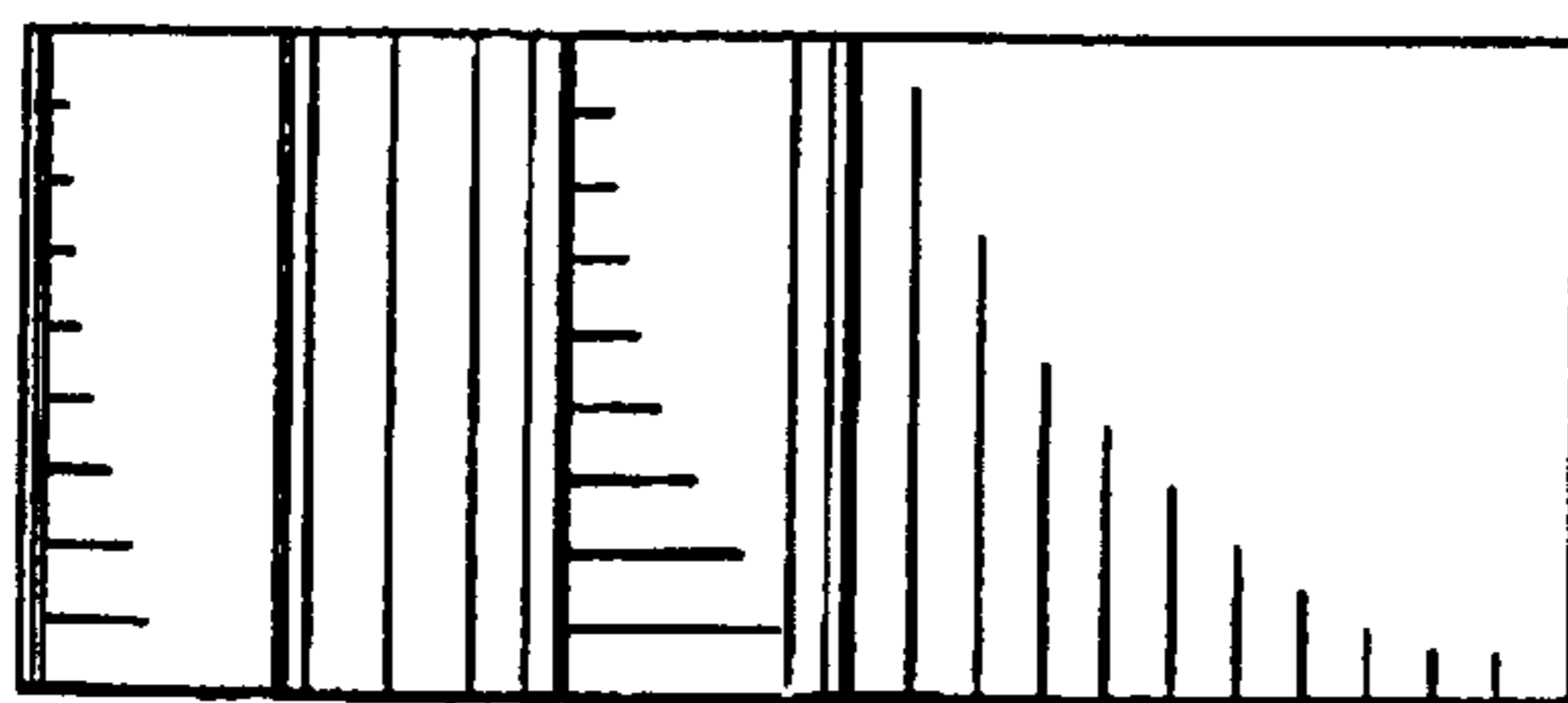

Fig. 5

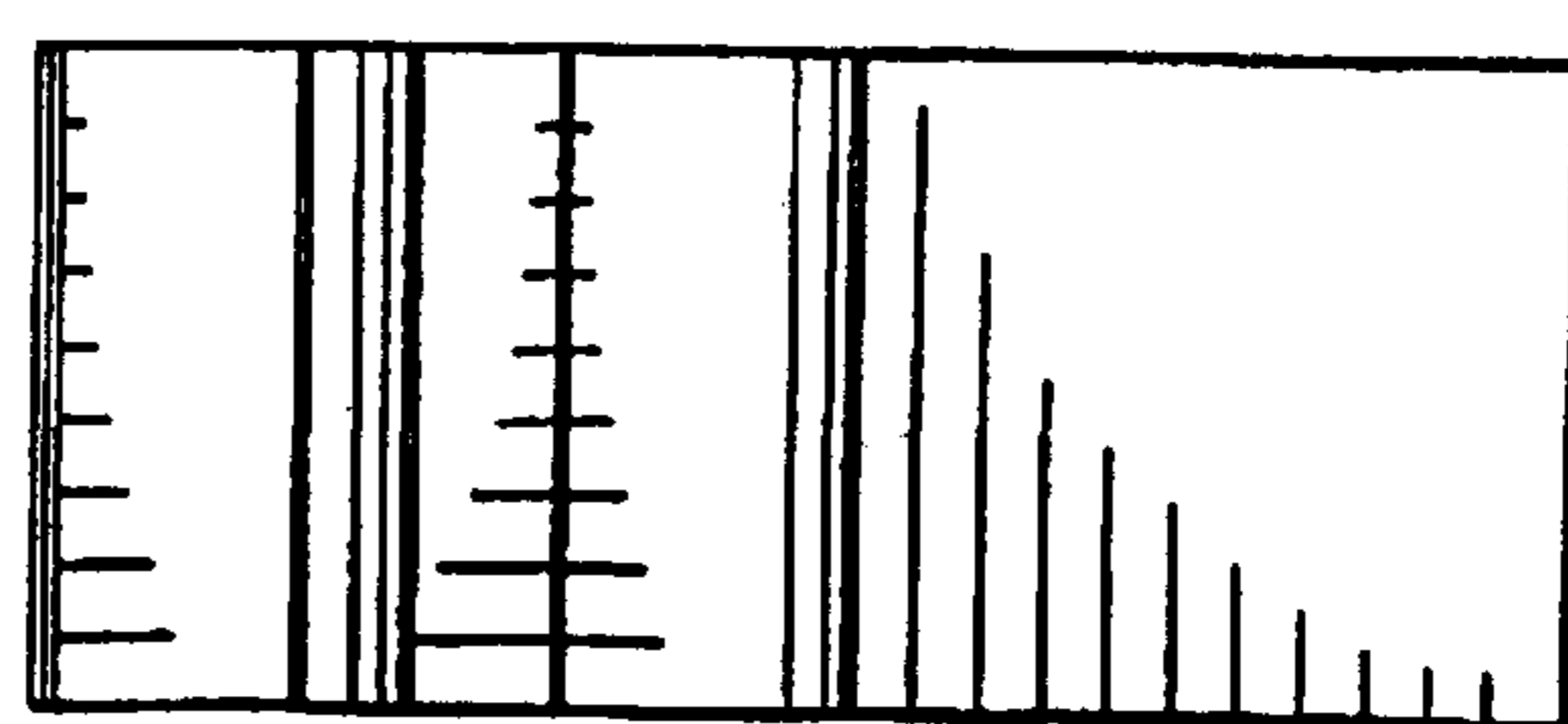

Fig. 6